

North American

Crosscut Saw Filing Tools

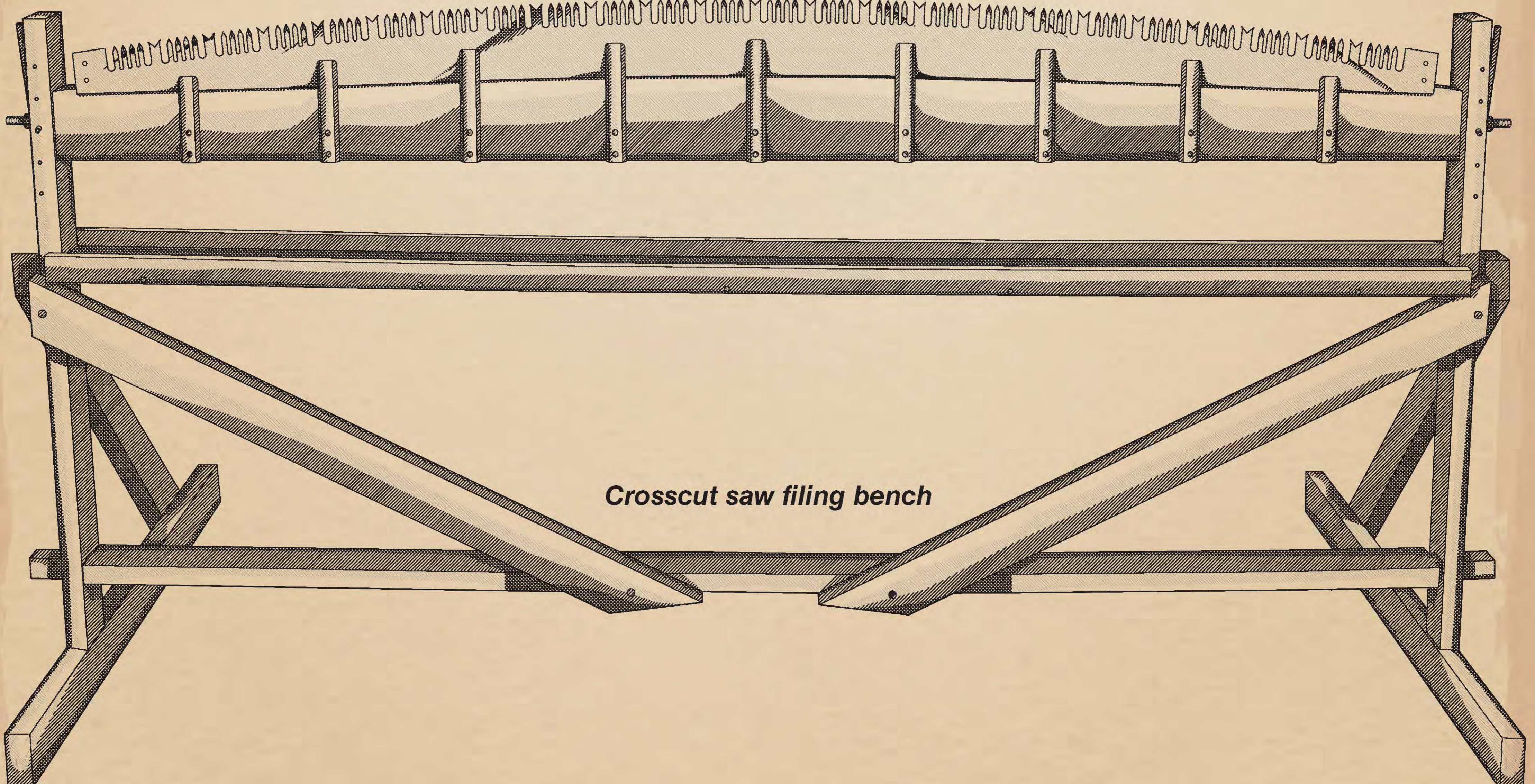
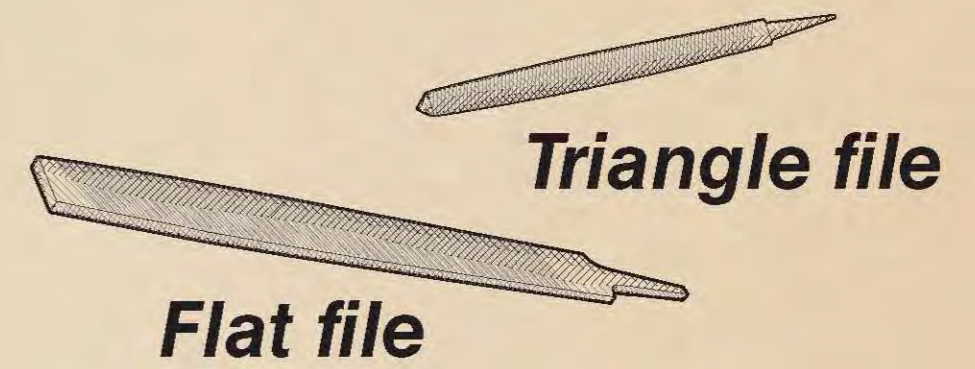
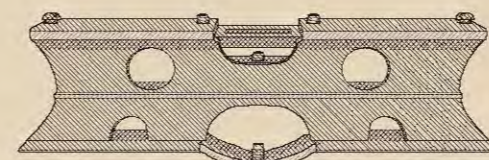
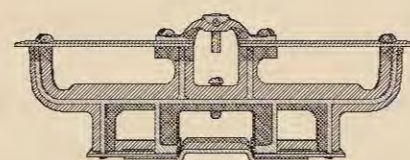
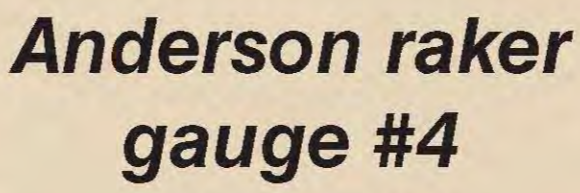
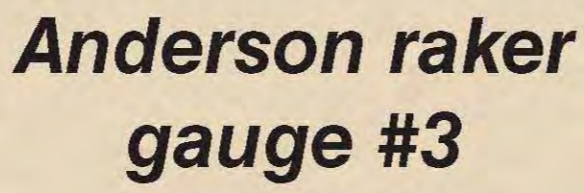
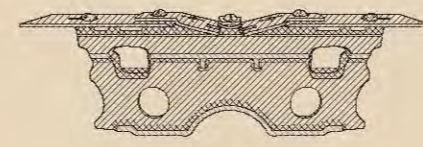
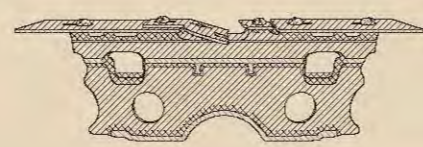
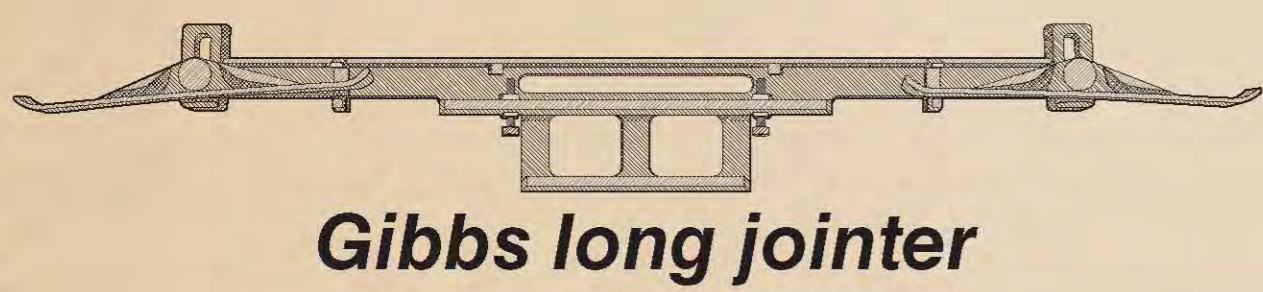
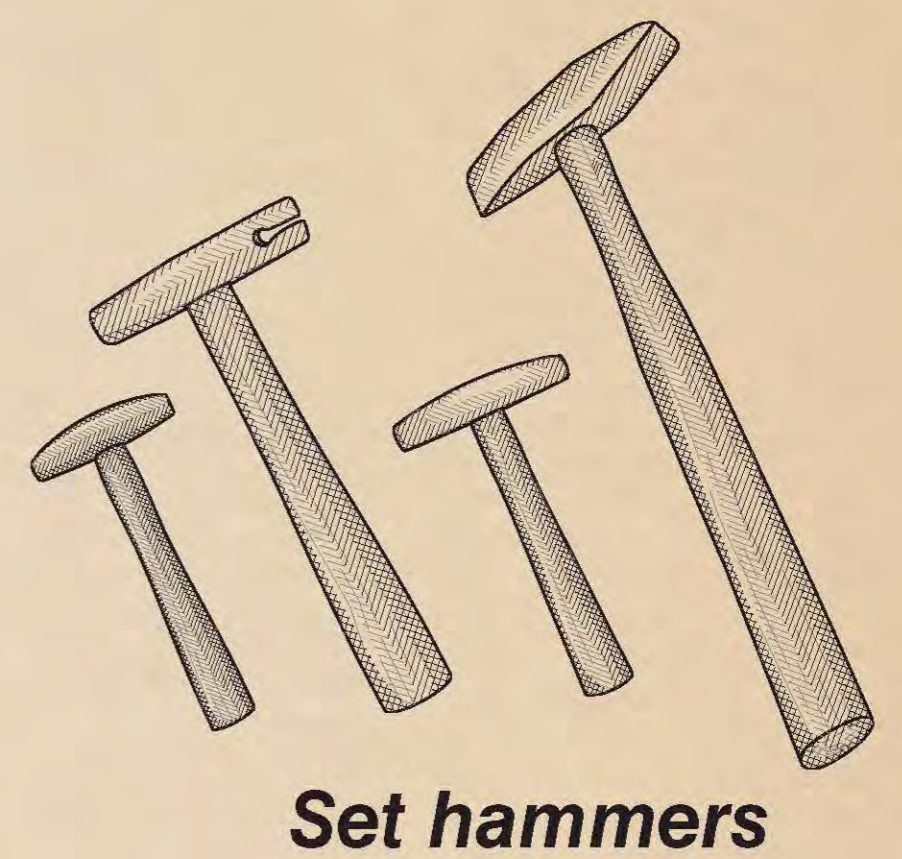
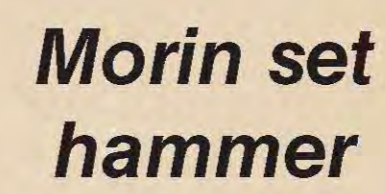
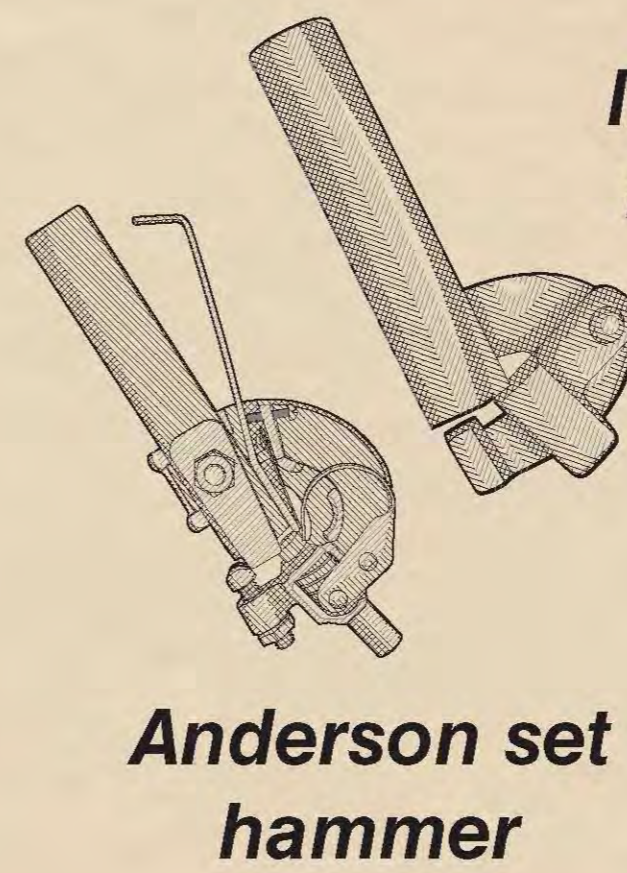
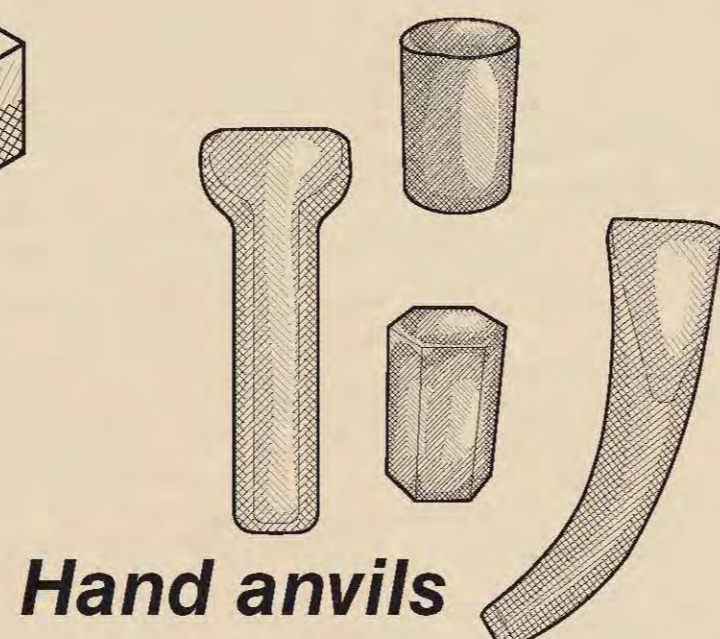
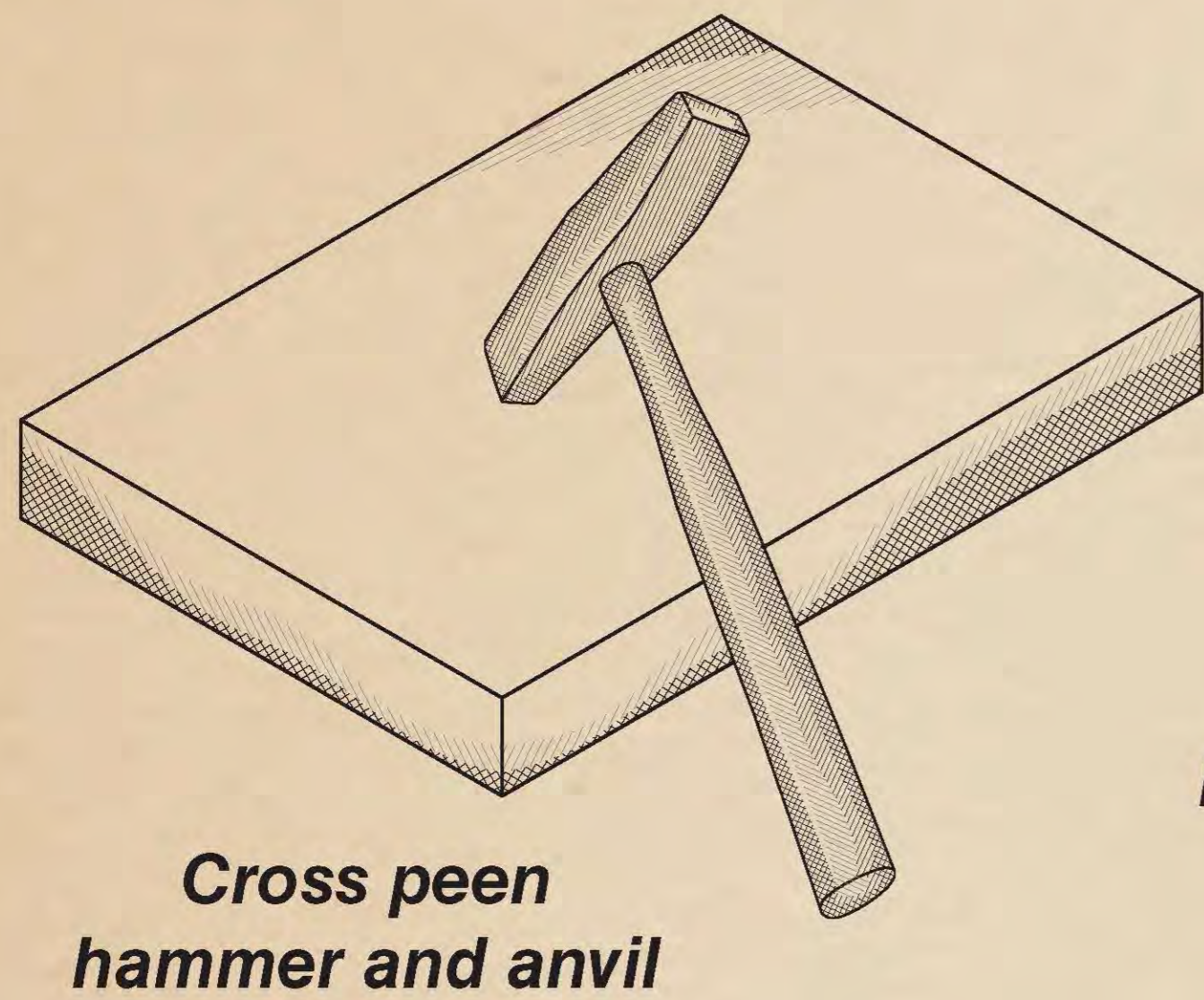
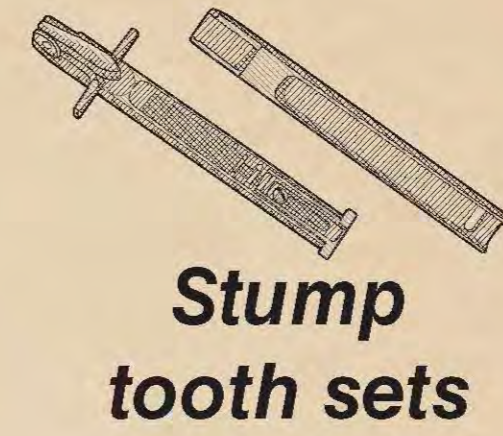
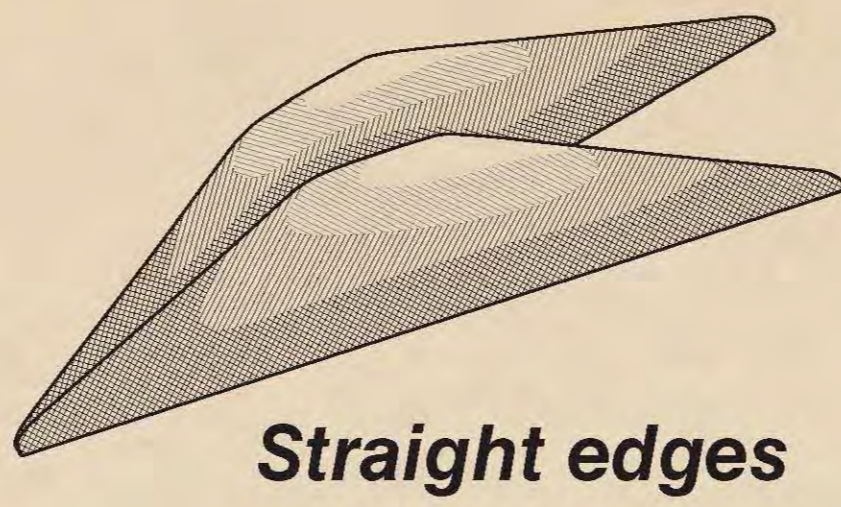
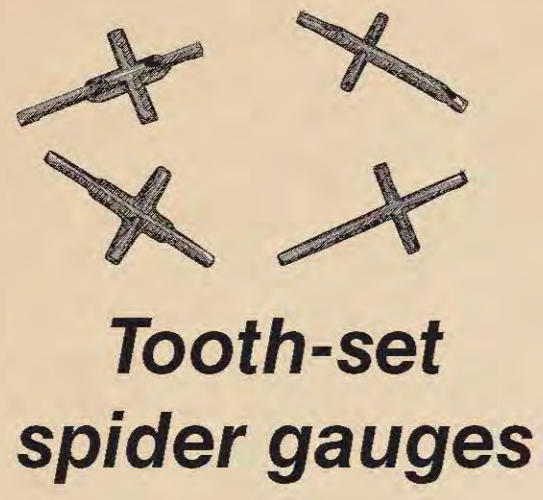

North American

Crosscut Saws and Saw Tooth Patterns

Common Crosscut Saws

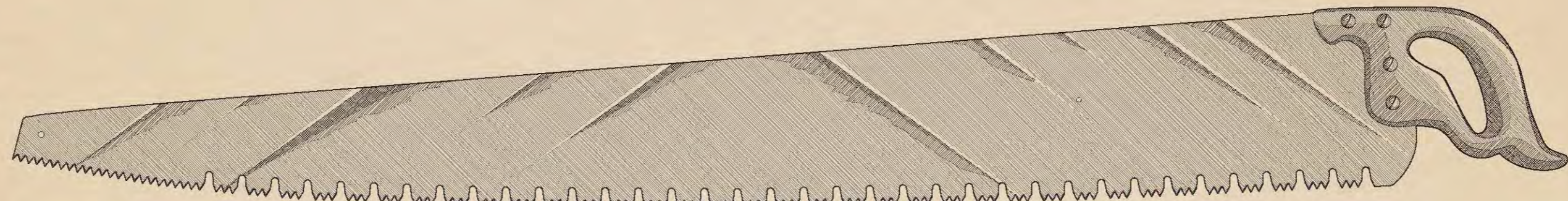

Great American tooth, one-person bucking saw

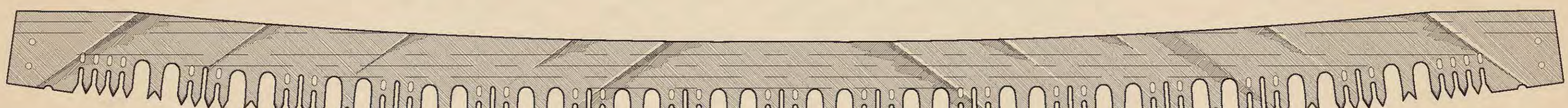

Perforated-lance tooth, two-peg ribbon saw

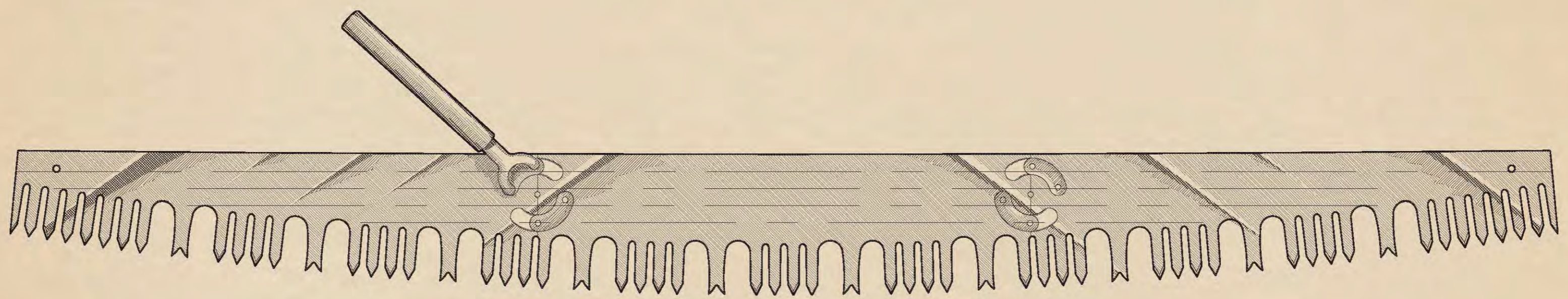

Lance tooth, three-piece saw

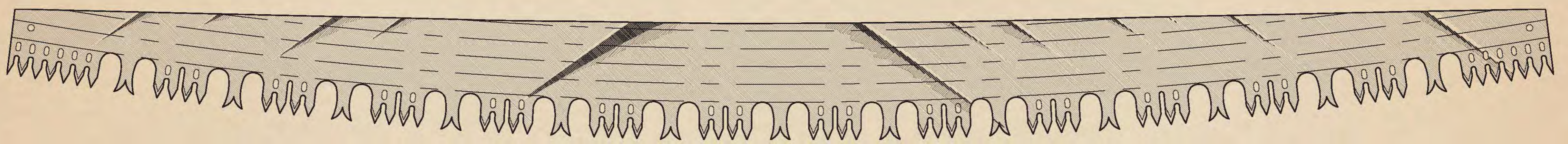

Lance tooth, four-peg felling saw

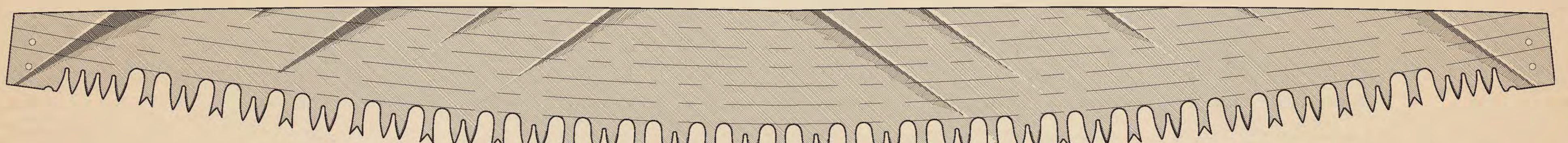

Champion tooth, two-peg bucking saw

Common Crosscut Saw Tooth Patterns

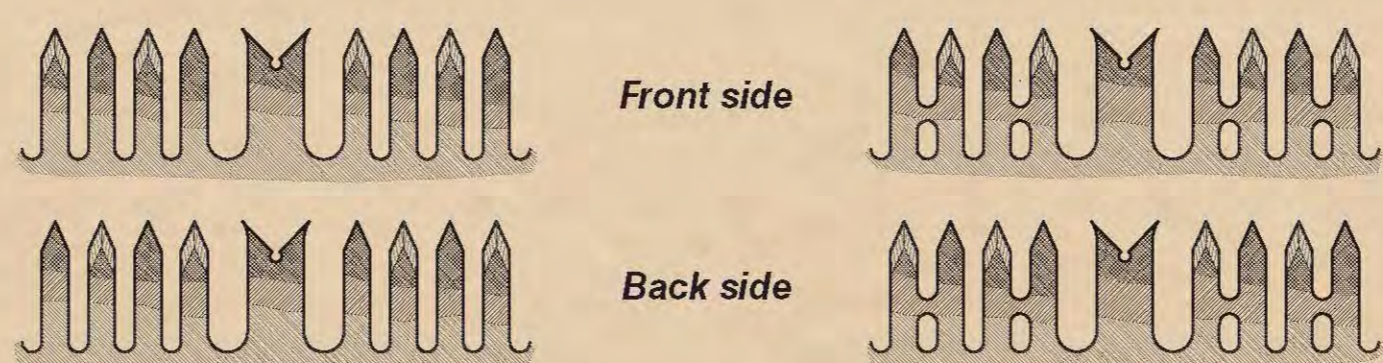
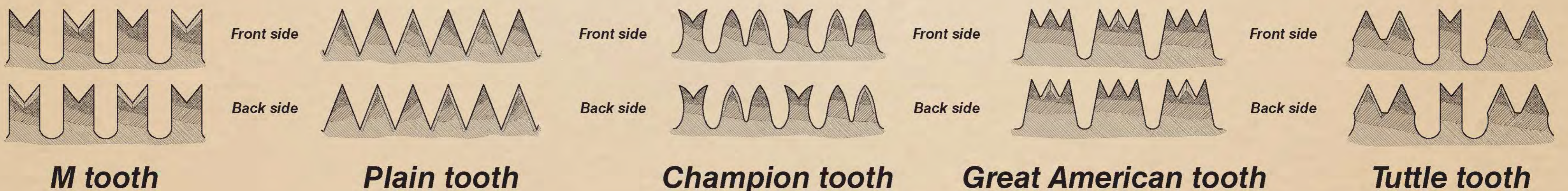

Lance tooth Perforated-lance tooth



North American

Crosscut Saw Handles and Related Tools



Hanging
(or tie)
wedges

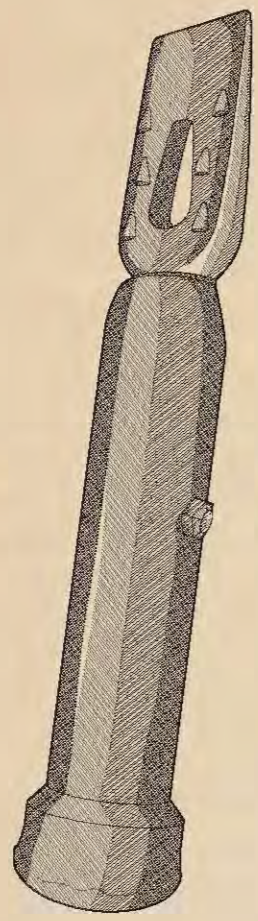

Explosives
wedge

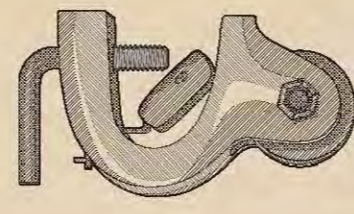

Ax handle-mounted
underbucker

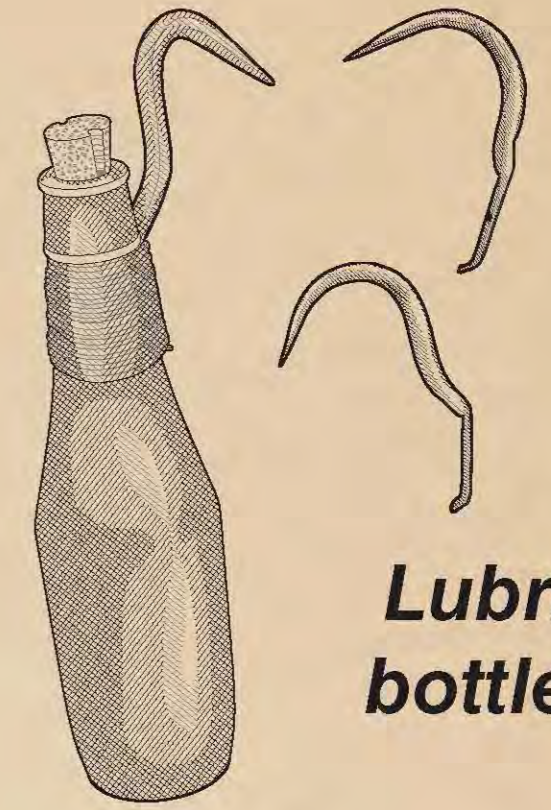

Lubricating
bottle hooks

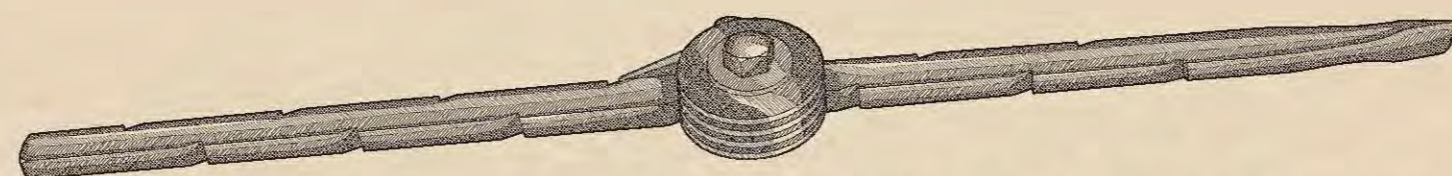

Mechanical underbuckers

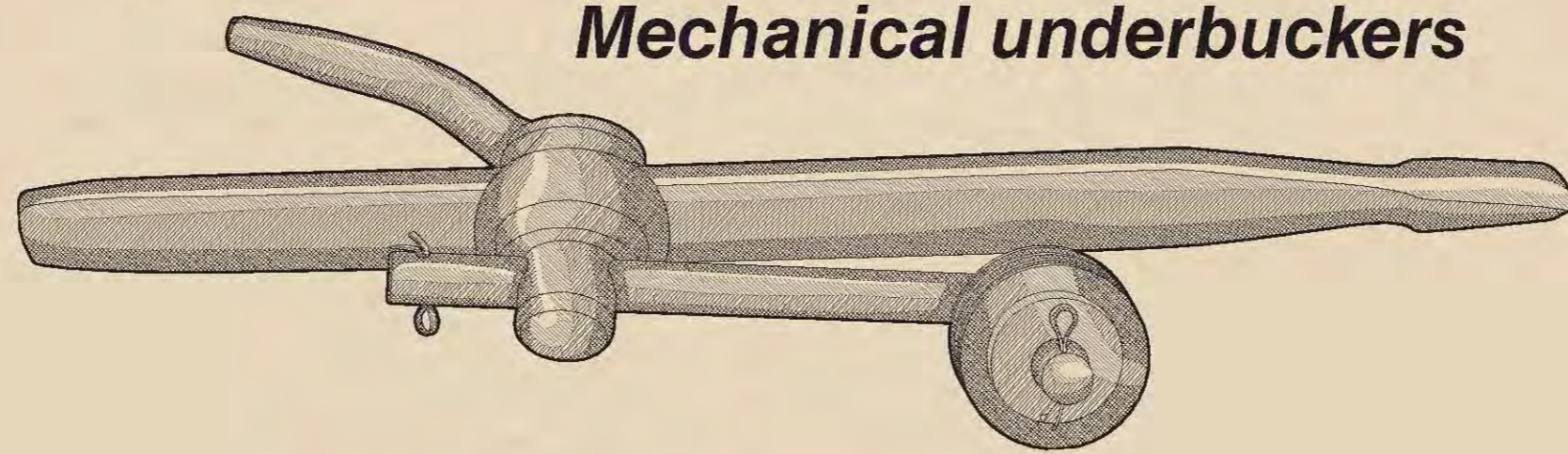

Kerosene lubricating
bottle with hook

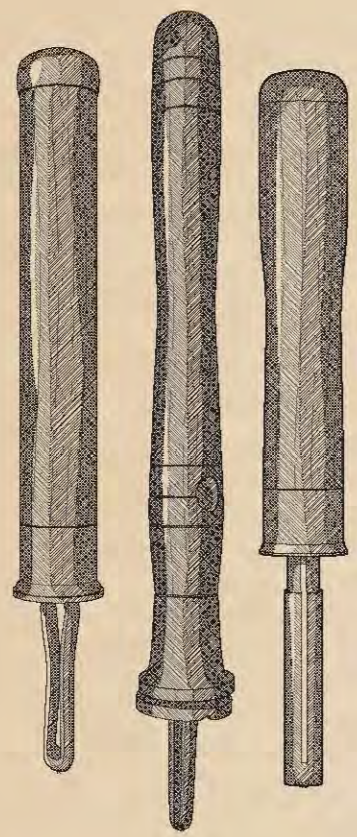

Eastern (or loop)
handles

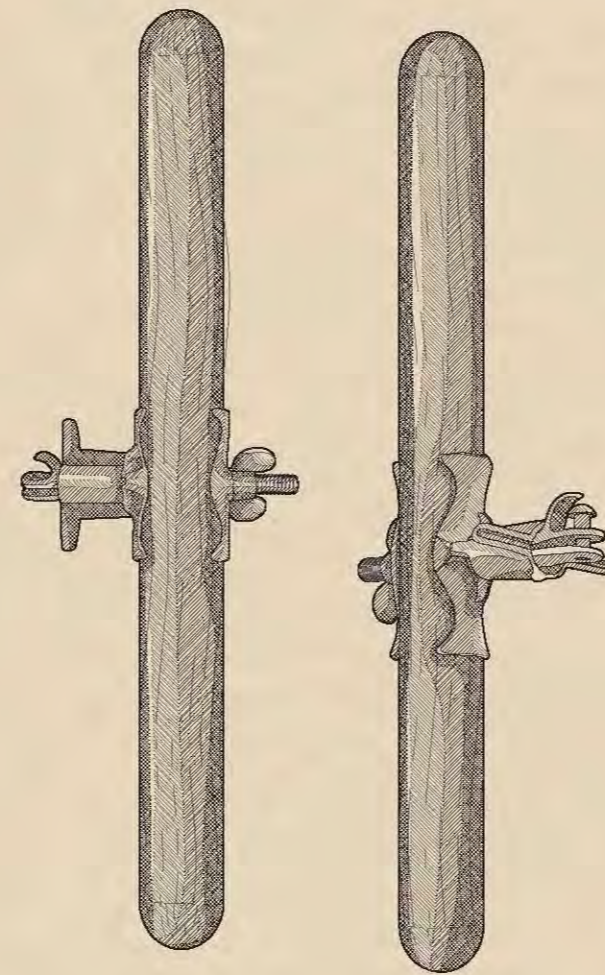

Climax pattern
handles

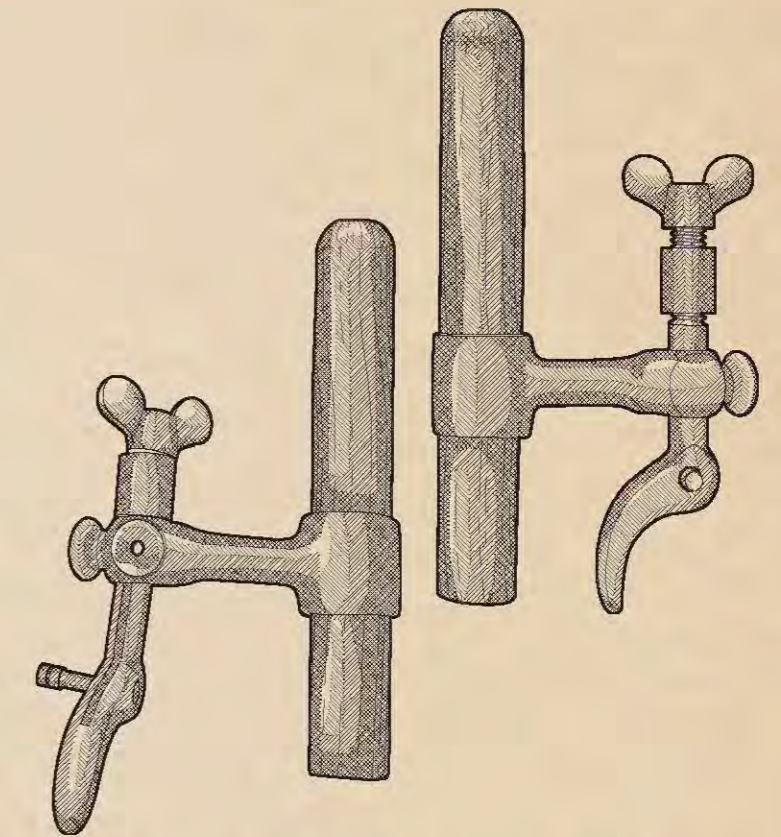

Sells handles

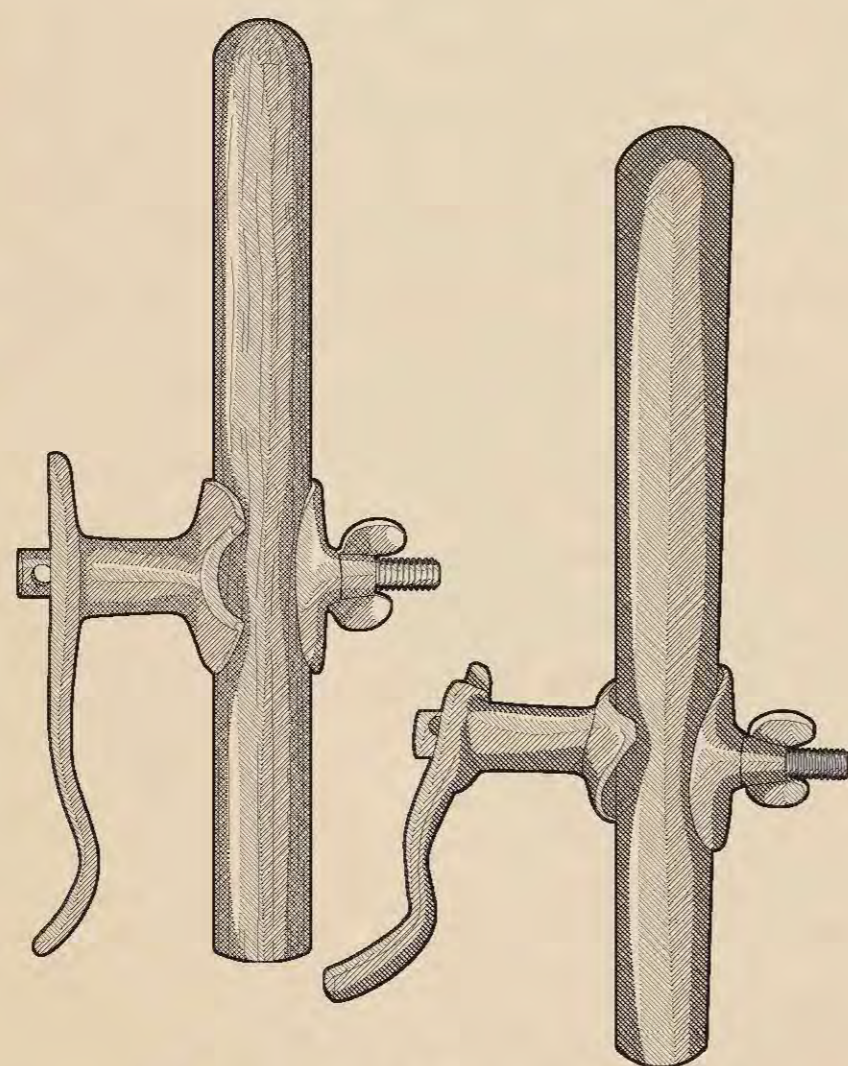

Western bucking
handles

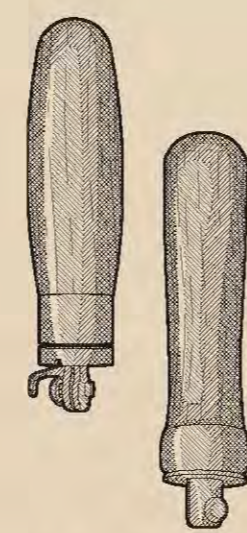

Helper
(or stinger)
handles
(one-person saw)

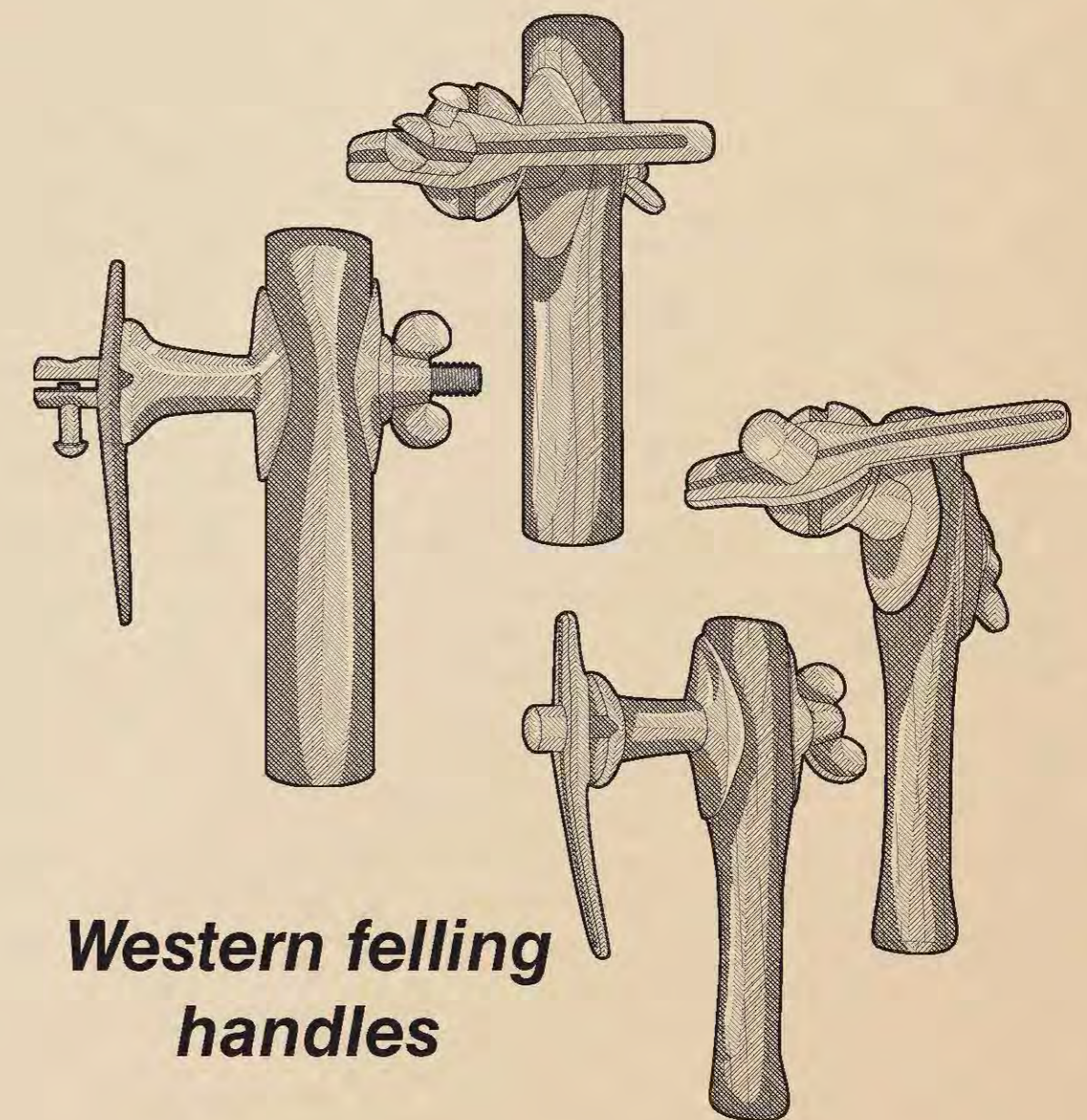

Western felling
handles

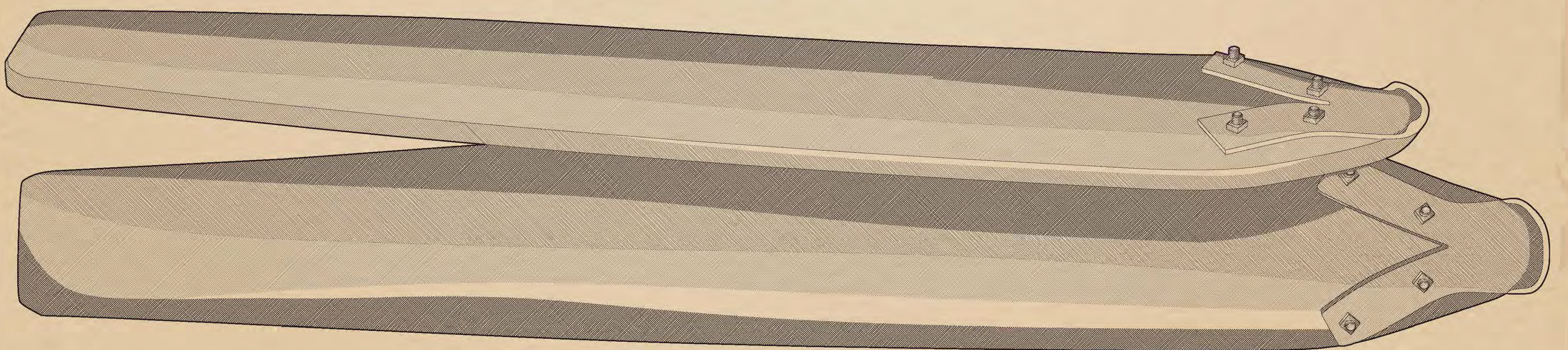

Springboards



Situational Awareness

Reactive Forces

Tension and Compression

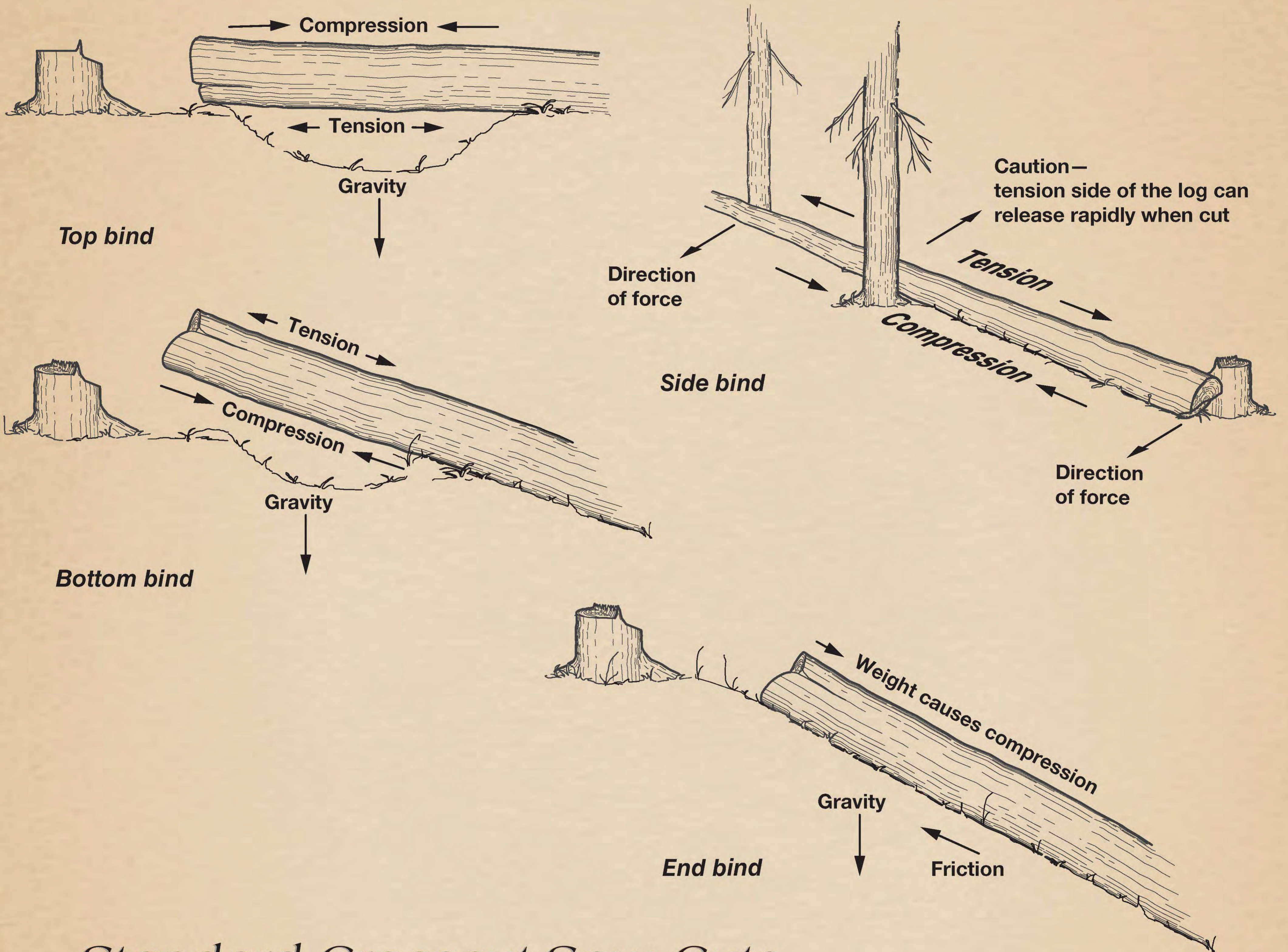

Standard Crosscut Saw Cuts

