



United States
Department of
Agriculture

Forest Service

Technology &
Development
Program

2300 Recreation
February 2005
0523-2810-MTDC



In cooperation
with

United States
Department of
Transportation

Federal Highway
Administration



Handtools for Trail Work

2005 Edition

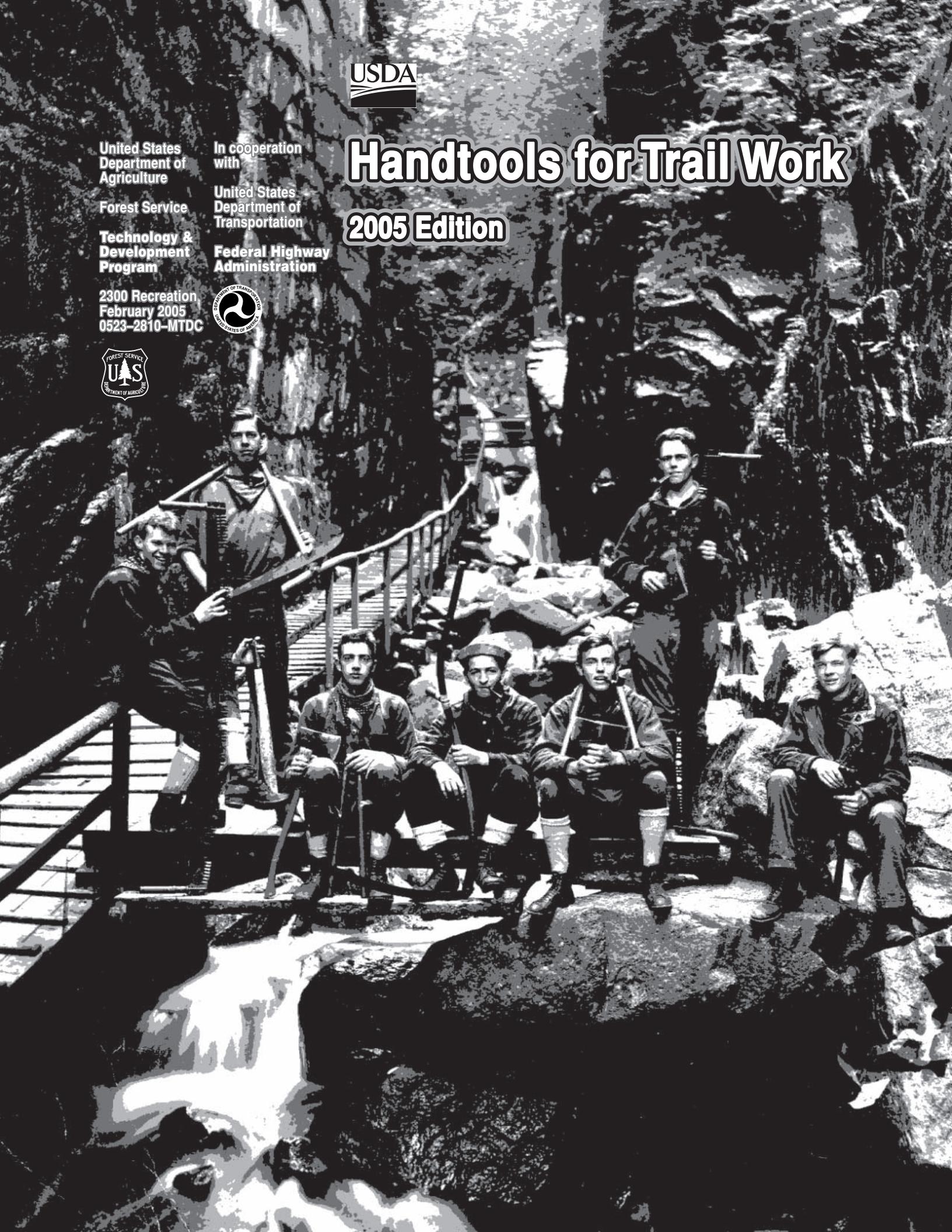

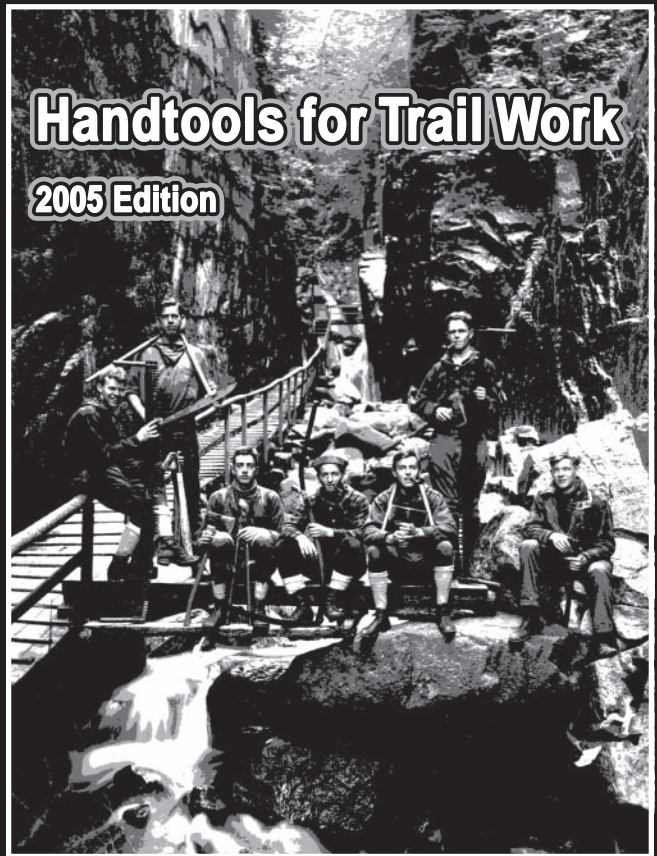

Richard Hallman
Forester (retired)

USDA Forest Service
Technology & Development Program
Missoula, MT

TE92A17—Technical Services, Recreation

February 2005
Updates *Handtools for Trail Work*, 1988
(8823–2601–MTDC)

The Forest Service, United States Department of Agriculture (USDA), has developed this information for the guidance of its employees, its contractors, and its cooperating Federal and State agencies, and is not responsible for the interpretation or use of this information by anyone except its own employees. The use of trade, firm, or corporation names in this document is for the information and convenience of the reader, and does not constitute an endorsement by the Department of any product or service to the exclusion of others that may be suitable.

The U.S. Department of Agriculture (USDA) prohibits discrimination in all its programs and activities on the basis of race, color, national origin, sex, religion, age, disability, political beliefs, sexual orientation, or marital or family status. (Not all prohibited bases apply to all programs.) Persons with disabilities who require alternative means for communication of program information (Braille, large print, audiotape, etc.) should contact USDA's TARGET Center at (202) 720-2600 (voice and TDD).

To file a complaint of discrimination, write USDA, Director, Office of Civil Rights, Room 326-W, Whitten Building, 1400 Independence Avenue, SW, Washington, D.C. 20250-9410, or call (202) 720-5964 (voice and TDD). USDA is an equal opportunity provider and employer.

Abstract

The Missoula Technology and Development Center (MTDC), working with trail crews throughout the United States, has standardized a comprehensive document on the use and maintenance of handtools involved in trail work. Information collected from industry experts, from interviews with trail crew members, and from extensive literature and

market research on the subject provides the text for this document. It stresses safe and efficient tool use. It describes each tool and presents nomenclature and maintenance procedures, including sharpening techniques and rehandling methods. The document is intended for both experienced and inexperienced trail crews.

Acknowledgments

This document was prepared by William R. Hutcheson and Dale Mrkich, former Forestry Technicians at MTDC. The work was accomplished under the direction of Jerry Oltman, former MTDC Forester and Project Leader.

Special thanks to MTDC staff Bert Lindler, Sara Lustgraaf, Brian Vachowski, and Gary Hoshide for helping develop this revised edition.

About This Document

The tools shown here are those used most often by Forest Service trail crews. They are categorized into tools for sawing, chopping, grubbing, digging and tamping, pounding

and hammering, lifting and hauling, peeling and shaping, and sharpening and rehandling. Each tool is described along with helpful techniques for use and maintenance.

ontents

Abstract	ii
Acknowledgments	iii
About This Document	iv
Introduction	1
Safe Trail Work	3
Tools for Sawing	5
Tools for Chopping	13
Tools for Grubbing	17
Tools for Digging and Tamping	21
Tools for Brushing	23
Tools for Pounding and Hammering	29
Tools for Lifting and Hauling	33
Tools for Peeling and Shaping	37
Tools for Sharpening	41
Tools for Rehandling	45
Bibliography	49
Appendix—American Pattern Files	51
Index	53

You can order a copy of this document using the order form on the FHWA's Recreational Trails Program Web site at: <http://www.fhwa.dot.gov/environment/rectrails/trailpub.htm>

Fill out the order form and fax it to the distributor listed on the form. If you do not have Internet access, you can send a fax request to 301-577-1421, e-mail your request to: report.center@fhwa.dot.gov, or mail your request to:

USDOT, Federal Highway Administration
Office of Human Environment, Rm. 3240
400 7th St. SW.
Washington, DC 20590

Produced by:

USDA Forest Service, MTDC
5785 Hwy. 10 West
Missoula, MT 59808-9361
Phone: 406-329-3978
Fax: 406-329-3719
E-mail: wo_mtdc_pubs@fs.fed.us
Web site: <http://www.fs.fed.us/t-d>
(Username: t-d; Password: t-d)

This document was produced in cooperation with the Recreational Trails Program of the Federal Highway Administration, U.S. Department of Transportation.

This document is disseminated under the sponsorship of the U.S. Department of Transportation in the interest of information exchange. The United States Government assumes no liability for its contents or use thereof.

The contents of this report reflect the views of the contractor, who is responsible for the accuracy of the data presented herein. The contents do not necessarily reflect the official policy of the Department of Transportation.

This report does not constitute a standard, specification, or regulation. The United States Government does not endorse products or manufacturers. Trade or manufacturer's names appear herein only because they are considered essential to the object of this document.



—Cover photo: *The 1924 Trail Gang in the Flume*, Courtesy of the Appalachian Mountain Club.



Introduction

Trail work requires many kinds of handtools like saws, axes, picks, hammers, shovels, and grub hoes. To be safe and productive, trail workers must know how to select the best tools for the job, use them skillfully, and maintain them correctly. However, modern technology has caused a gap in our handtool knowledge. Most trail tools have become uncommon in our everyday work world, which contributes to accidents, low productivity, and frustration.

This manual should help reduce accidents and increase production. It is intended for Forest Service employees, volunteers, and others who do trail work. It provides tips for using and maintaining common trail tools. Proper use and maintenance of handtools contributes to safe and efficient trail work and to a better trail system.

Safe Trail Work

Keys to productive, safe, trail work are sharp tools, proper tool use, team work, and awareness of hazards. Such knowledge cannot come from a manual. Ask experienced crew members for help. Work as a team. Watch for hazards to other crew members. Alert each other to unsafe tools and hazards. Productive, safe crews depend on each member being alert, informed, and caring.

There are general safety rules to observe when using handtools. Survey the environmental hazards surrounding each task and use proper personal protective devices like hardhats, gloves, and safety glasses. Select the right tools for the job. Carefully inspect their condition before you use them. Make sure handles are sound, smooth, and straight; heads are tight; and cutting edges are sharp.

Avoid transporting tools loose in vehicles. Use tool boxes. Place tools in sheaths, especially if they have sharp cutting edges. Load and unload tools with care. Always use gloves. Pass tools so others avoid grasping a cutting edge. Never throw a tool.

Be aware of nearby workers. On the trail, carry tools by holding them at your side and downhill, with blades forward and the handles behind. If you should slip, drop the tool to the side to prevent falling on the blade. Designate a central drop point for tools near the worksite so tools are less likely to be lost. Mark handles with a small strip of bright orange paint for easy visibility.

You need training to use a crosscut saw. Your training, experience—and in some cases—level of certification, can allow you to buck trees already on the ground, or to undertake the more advanced (and hazardous) business of felling standing trees. Be sure you are properly trained and certified before cutting either standing or fallen trees. Remember that using an ax exposes you to similar hazards.

At day's end, identify tools that need maintenance and schedule time for repairing or replacing tools. In the field, store tools safely and out of the weather.

Tools for Sawing

Crosscut Saws

There are two types of crosscut saws. Symmetric crosscut saws are designed for a sawyer at each end, and asymmetric saws require only one sawyer. They are heavier so they can be pushed and pulled without buckling. There are two basic patterns for symmetric crosscuts—*felling crosscuts* are light, flexible, and have concave backs that conform easily to the arc of the cut and the sawyer's arm. The narrowed distance between the teeth and back helps sawyers wedge the cut quickly. Felling saws are usually preferred by trail crews. *Bucking crosscuts* have straight backs and are heavier and stiffer than felling saws. Their weight helps the saw cut faster and the stiffness prevents buckling on the push stroke when one person saws. Most asymmetric saws are bucking saws. Symmetric saws are pulled by each sawyer. There is no push stroke.



Crew members using a bucking crosscut saw.

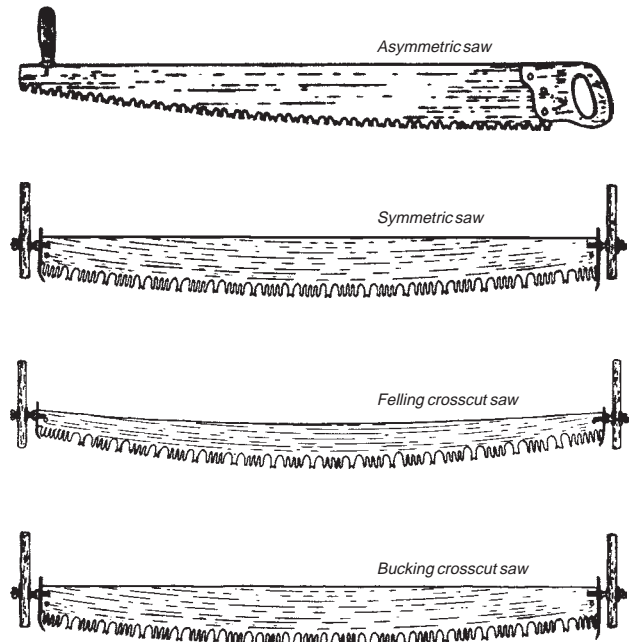

Types of crosscut saws.

The points of most crosscut saw teeth lie on the arc of a circle. These cut easier than a straight-tooth saw and are almost as simple to maintain. Crosscut blades are ground *flat* or ground with a *taper* from front to back. A flat-ground blade displays uniform thickness throughout. Flat-ground saw teeth require more “set” than taper-ground saw teeth.

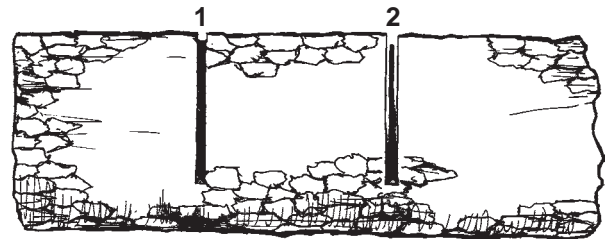

1—A cut made with flat-ground teeth tends to bind when cutting under compression.

2—A cut made by taper-ground teeth is less likely to bind.

Taper-ground saws vary from thick-at-the-teeth to thin-at-the-back so their teeth require less set. Taper-ground saws work well for trail jobs because they begin cuts quickly and are slower to bind than flat-ground saws. For all-around trail use, a taper-ground felling crosscut is very effective. Taper-ground saws are often called *crescent*, *precision*, *segment*, or *arc-ground* saws.

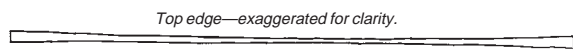

CRESCENT TAPER-GROUND SAW



- Each line represents uniform thickness—tapering from thicker at the teeth to thinner at the top.
- The teeth are a uniform thickness.

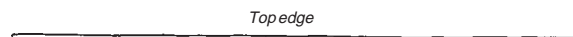

STRAIGHT TAPER-GROUND SAW

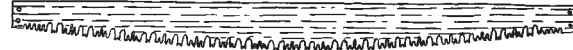

The teeth vary in thickness.



One-person saw blades vary from 3 to 4½ feet and these saws weigh 4 to 5 pounds. Two-person saws generally have 6-foot blades and weigh about 8 pounds.

Many modern crosscuts have solid ends. That is, the teeth do not extend to the ends of the blade. For finishing some cuts, however, you will often need a saw with teeth continuous to both ends. A saw with continuous teeth is needed to cut a log in dirt or deep duff, for example.

Before sawing a log with a crosscut, “swamp” the area to remove materials that could interfere with the cut. Next, check the “lay of the log” to determine what will happen when the cut is made. Saw from the uphill side unless you are placing an undercut on a standing tree. Remove loose bark from the line where the saw will pass. Avoid getting the saw into the dirt at the end of the cut. If necessary, place a piece of bark under the log or dig it free under the cut. Make final strokes with one end of the saw so only end teeth will dull if you slip.

When carrying a saw, lay it flat across one shoulder with the teeth guarded and facing away from the neck. Carry the saw on the downhill shoulder. Grasp the front handle from under the blade. Remove the rear handle to prevent snagging on overhanging limbs. Transport saws at the rear of a line of workers. Use blade guards made of sections of rubber-lined firehose slit lengthwise with Velcro fasteners to facilitate removal. Saws need extra protection when they are transported in a vehicle. They should be secured between pieces of plywood cut to blade width, or otherwise protected. Store saws straight. Either hang them or lay them flat. Storing saws in a bent position can bow the saw. Before storing, the blade should be coated with a protectant to prevent corrosion. Never store a saw in a wet sheath.

A sharp crosscut is a pleasure to operate, but a dull or incorrectly filed saw is a source of endless frustration. Quality crosscut saw filers are increasingly difficult to find. Good instruction for crosscut saw filing is still available, however. We recommend *The Crosscut Saw Manual* by Warren Miller (Tech. Rep. 7771–2508–MTDC, rev. 2003). The manual discusses in detail how a saw works and offers experience-tested methods for choosing, using, and maintaining a saw. Copies are available from MTDC.

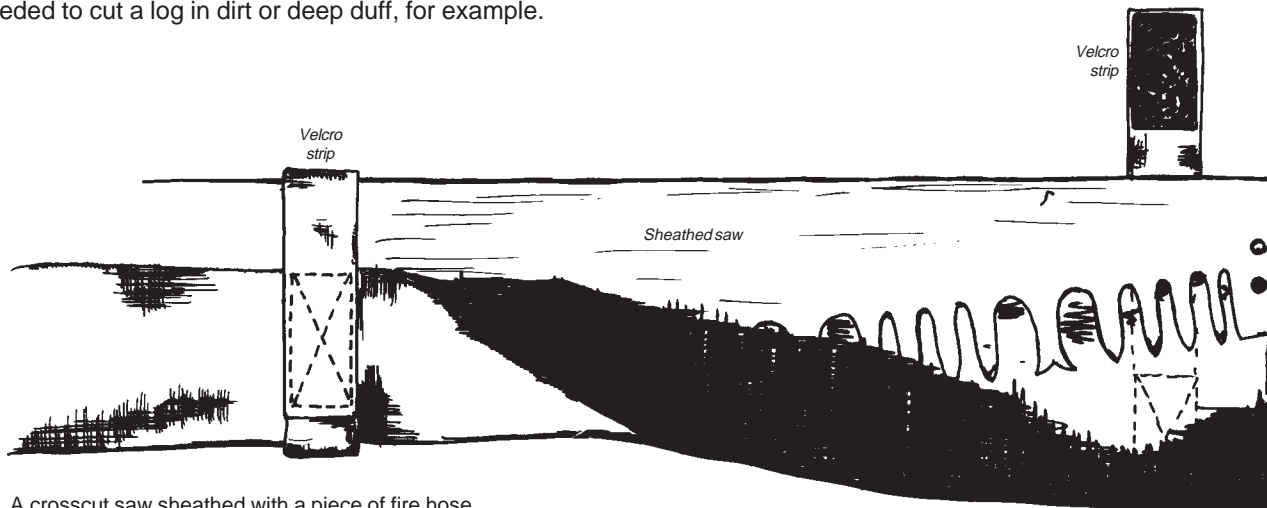

A crosscut saw sheathed with a piece of fire hose.

Tree sap may bind the crosscut blade in the cut. To prevent this, lightly lubricate the blade with a citrus-based solvent. If a flask is stoppered with a cork that has been grooved lengthwise, the blade can be evenly coated with a film of citrus-based solvent by inverting the flask and whisking the cork along the blade surface. An alternative would be a squirt bottle of citrus-based solvent that could spread a small stream of the fluid along the blade.

A leaning tree will have compressed fibers on its underside. In this case, a cut on that side could quickly bind a saw even after it has been undercut. If this happens, saw as much as possible, remove the saw, and chop away the severed wood. A down log can be under compression if it is only supported on the ends. A cut made in the middle will bind the saw as the weight of the log closes the kerf. Sometimes a cut can be continued by driving a wedge into the cut behind the saw. If the saw still binds, one sawyer should “underbuck” the log from the bottom. Remove one handle to reduce the chance of the blade “kinking” if the severed log carries it to the ground. Plant an ax in the log so the handle can support the back of the saw. Slightly notch the handle for a saw guide. Linseed oil in the notch allows the saw to run easily and minimizes handle wear. The flexible hickory holds the saw in the cut.

The cutting teeth of a crosscut saw sever the fibers on both sides of the kerf. The raker teeth cut like a plane, peel the fibers, and collect them in sawdust gullets between the teeth. From there they are carried out of the cut. A properly sharpened crosscut cuts deep and makes thick shavings.

Placement of the handles also determines how the saw cuts. For a vertical cut with the teeth pointing down and the handles up, the pull stroke will be easier the farther toward the end of the handle the hands are placed. Pointing the handles down reverses the situation. For saws that have two holes on each end, changing the handle position from the lower to the upper hole will have the same effect as moving the hands several inches up the handle.

Another good reference that presents time-tested techniques for using and maintaining crosscut saws is *Saws That Sing: A Guide to Using Crosscut Saws* (Tech. Rep. 0423–2822–MTDC), by David Michael. Copies are available from MTDC.

Hand Chain Saws

The hand chain saw weighs only 2 pounds compared to 11 to 16 pounds for a conventional crosscut saw. The saw showed promise during early testing, but over time, it has not proved to be a suitable replacement for a traditional crosscut saw. It may be appropriate for occasional or emergency use. It is safer to carry and easier to pack.

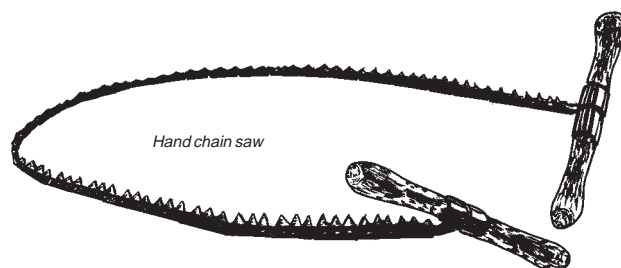

Bow Saws

Bow saws are useful for clearing small downfall and for limbing. Modern bow saws come in many sizes and consist of a tubular steel frame designed to accept replaceable blades. Blades detach by loosening a wing nut or releasing a throw clamp. The *clamp-type saw* does not require nuts and bolts that are easily lost. Unless spare nuts or bolts are carried along, the saw becomes useless. Blade lengths can vary from 16 inches to 36 inches. Saws weigh from 1 to 4 pounds. Let the saw do the work. Apply a little downward force with each stroke. When the bow saw is used for one sawyer, lean slightly over the frame and let your weight provide some downward pressure with each push of the blade. Forcing the blade into the cut may bind or break the blade. Use as much of the length of the blade as possible; the saw will cut smoother and stay sharp longer.

Although the bow saw is designed for one person, two people can saw large logs more effectively. Two people operate the bow saw like a crosscut—each works only on the pull stroke.

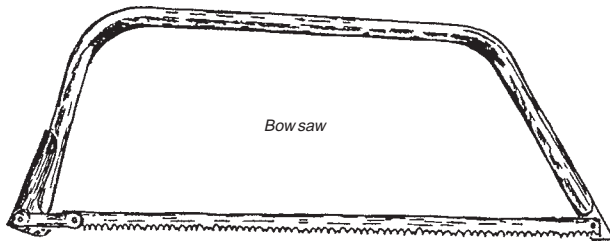

The teeth are needle-sharp, so wear gloves when sawing and keep hands clear of the cut and the blade. Carry bow saws by your side with the blade pointed down. Sheathe the blade with small-diameter fire hose and Velcro fasteners or plastic blade guards when not in use. Always carry spare parts and plenty of replacement blades on the trail.

Since worn blades are replaced rather than sharpened, maintenance consists of blade replacement, periodic checks to see that bolts are tight, and an occasional light oiling. Take care when oiling these and other trail tools. Too much oil can trap dirt in tool joints.

Examples:

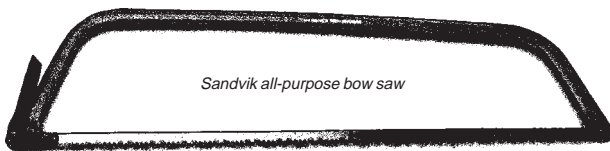

The Sandvik all-purpose bow saw has a hardened $\frac{3}{4}$ -inch by 36-inch blade, and a Swedish steel frame with a knuckle guard. The blade changes easily and has a tension lever. Its weight is $2\frac{1}{4}$ pounds.

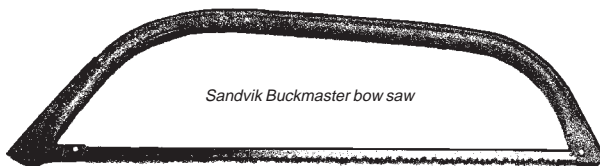

The Sandvik Buckmaster is used for heavy-duty bucking jobs. The precision $\frac{3}{4}$ -inch blade never needs refiling. The frame is Swedish oval tubing, with a knuckle guard and a tension lever for quick blade change. It weighs 3 to $3\frac{1}{2}$ pounds.

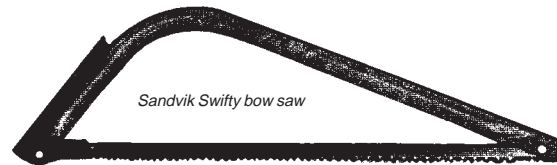

The Sandvik Swifty is designed for light pruning and landscape work. The tension-mounted blade is $\frac{3}{4}$ inch wide and 21 inches long, and features a peg-tooth design. The quick-action tension lever facilitates blade changing. It has a Swedish steel frame with a knuckle guard, and weighs $1\frac{1}{4}$ pounds.

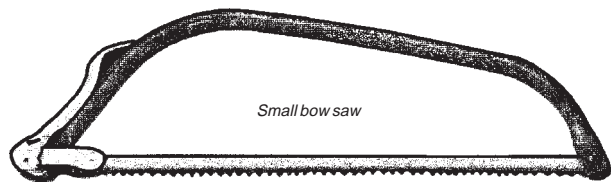

A small bow saw is used for pruning, limbing, landscaping, camping. The 21-inch raker tooth blade is quickly and easily replaced using a tension lever. The strong tubular steel frame is designed to allow use of the entire cutting blade. It weighs $1\frac{1}{2}$ pounds.

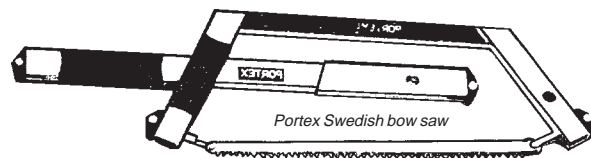

The Portex self-storing Swedish bow saw features a $\frac{3}{4}$ - by 16-inch Swedish steel blade with raker teeth for cutting firewood, limbs, or lumber. It has an aluminum frame with a no-slip, plastic hand grip. All parts disassemble and "nest" inside the handle, and are easy to reassemble. Weight is $1\frac{1}{4}$ pounds.



Bow saws effectively clear trails.

Pruning Saws

Pruning saws are useful for limbing, some brushing, and removing small downfall, especially where space is limited and cutting is difficult. The triangular handle design limits cutting depth, however. Blades vary from 10 to 36 inches, and saws weigh from $\frac{3}{4}$ to $2\frac{1}{2}$ pounds.



Pruning saws used in trail clearing quickly limb small branches.

Folding pruning saws are also handy. Some triangular saws collapse for carrying; other folding saws have a curved blade with teeth on the underside attached to a short handle by a bolt and wing nut. The bolt and nut lock the blade open for use and closed for carrying, like a pocket knife. These blades may be sharpened with a 6-inch cant

saw file. Blades are also easy and inexpensive to replace. Check the bolt often for tightness. Carry replacement parts.

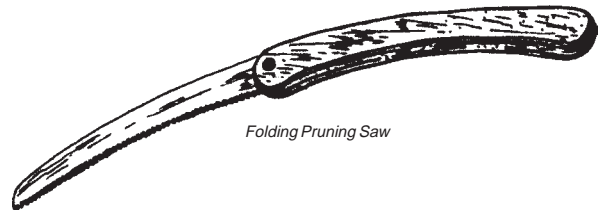

Folding Pruning Saw

Smokejumpers use folding saws to retrieve parachutes and other equipment from trees or bushes.

Pruning saws should be used, maintained, and carried like bow saws.

Pruning saws used in trail clearing quickly limb small branches.

Examples:

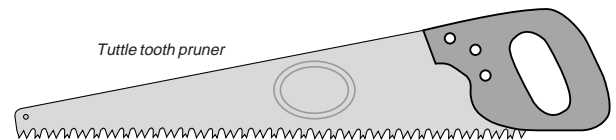

Tuttle tooth pruner

The Tuttle tooth pruner is a handy all-purpose saw for general pruning requirements. The teeth are designed for fast cutting of large limbs and firewood. The 21-inch blade is $\frac{4}{8}$ inches wide at the butt, and $\frac{1}{8}$ inches wide at the point. Weight is $1\frac{1}{4}$ pounds.



Meylan pruning saw

The Meylan pruning saw combines a curved ax handle and a curved saw blade that enables a sawyer of average height standing on the ground to prune nearly 10 feet high. The handle is 36 inches long and the blade is 16 inches long. Weight is $2\frac{1}{2}$ pounds.

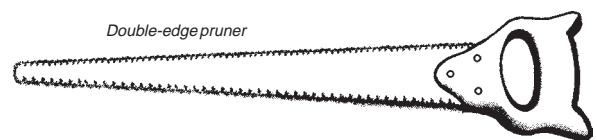

Double-edge pruner

The double-edge pruner has fine teeth on one edge for light trimming, and lightning teeth on the other edge for heavier jobs. The blade is $2\frac{1}{2}$ inches wide at the handle, and $\frac{29}{32}$ inch at the point. The fine edge has eight points per inch, and the other edge is $\frac{1}{32}$ -inch pitch lightning teeth. Weight is about 1 pound.

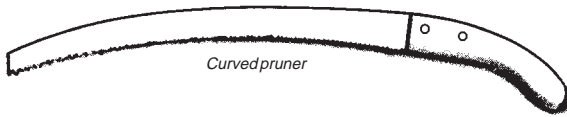

Curved pruner

The curved pruner is an excellent general-purpose pruner for fast cutting of small limbs. It has an easy-to-grip, knife-type wood handle, and is trimmed with nicked screws. The 14-inch blade has seven reverse-rip points per inch and is $1\frac{1}{2}$ inches wide at the handle, and $\frac{9}{16}$ inch wide at the point. Weight is $\frac{1}{2}$ pound.

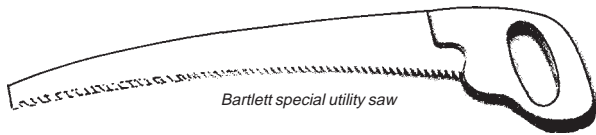

Bartlett special utility saw

The Bartlett special utility saw has a 24-inch diamond-tooth pattern blade (four points per inch). Weight is $1\frac{1}{2}$ pounds.

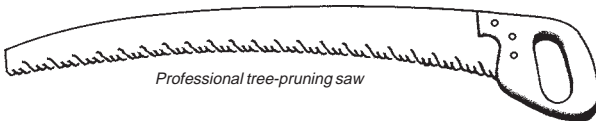

Professional tree-pruning saw

The professional tree-pruning saw (heavy-duty) has extra-large teeth and gullets for speed cutting of large limbs. The concave cutting edge is precision set and beveled-filed, and cuts fast on the pull stroke. The blade is flat-ground, 26 inches long, $3\frac{5}{16}$ inches wide at the butt, and $1\frac{13}{32}$ inches at the point. Weight is $1\frac{1}{2}$ pounds.

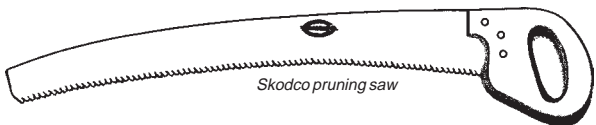

Skodco pruning saw

The Skodco pruning saw has a 24-inch blade with special baked-on blue finish and straight-toothed edge for cutting on the pull stroke. The extra large hand hole enables easy use while wearing gloves. The blade is $3\frac{3}{16}$ inches wide at the butt, $1\frac{3}{8}$ inches at the point, and has $4\frac{1}{2}$ points per inch. Weight is $1\frac{3}{4}$ pounds.



Folding pruner

The folding pruner has a 10-inch curved blade with a sure-grip wood handle that folds to protect the cutting edge. The blade has $6\frac{1}{2}$ cross-cut points per inch, and is $1\frac{15}{16}$ inches wide at the butt, and $\frac{1}{2}$ inch at the point. Weight is $\frac{3}{4}$ pound.

Pole Saws (Pole Pruners)

This saw has a curved blade attached to a long extension handle and is used to prune high protruding limbs. The teeth face backward on the underside of the blade, so the cut is made on the pull stroke. The curved blade helps prevent binding and transfers the weight of the tool to the branch to aid cutting. Handles typically extend from 4 to 16 feet.



Pole pruning saw

When using a pole saw, be aware of other workers nearby. Cut only those limbs whose ends you can see. Clear an area for dropping limbs. When cutting larger limbs, make two cuts. Begin with a slight cut on the underside of the branch to prevent bark from tearing when the limb is severed from the top.

Carry pole saws by your side. Grip the handle near the blade and point it away from your body and down. Long handles may require another worker to carry the tool farther back on the handle. Don't let the end of the handle drag on the ground.

Sharpen these saws with a slim taper file. Pole saws have alternately offset teeth that are beveled on both edges. Clamp the blade so the gullets are exposed about $\frac{1}{8}$ -inch to minimize chatter during sharpening. Align the file in the first gullet against the front and trailing edges of two adjacent teeth. The file should form an angle of about 65° with the blade. File every other gullet, then reverse direction and file alternate gullets at the same angle. Four or five strokes per tooth should suffice. File teeth equally; unevenly filed teeth will differ in height. The shorter teeth will be ineffective while cutting.

When transporting blades, provide a small protective box that holds approximately 10 to 15 blades vertically. Each blade should be separated by a $\frac{1}{4}$ -inch plywood partition.

Examples:

Telescoping fiberglass tree pruner

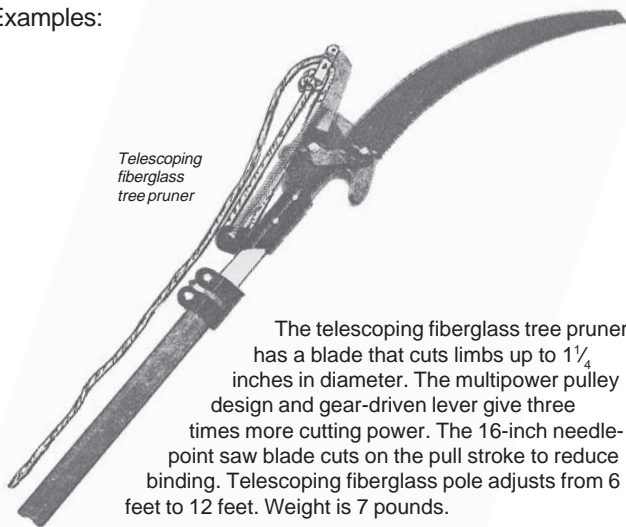

The telescoping fiberglass tree pruner has a blade that cuts limbs up to 1 1/4 inches in diameter. The multipower pulley design and gear-driven lever give three times more cutting power. The 16-inch needle-point saw blade cuts on the pull stroke to reduce binding. Telescoping fiberglass pole adjusts from 6 feet to 12 feet. Weight is 7 pounds.

Cord-actuated pruner

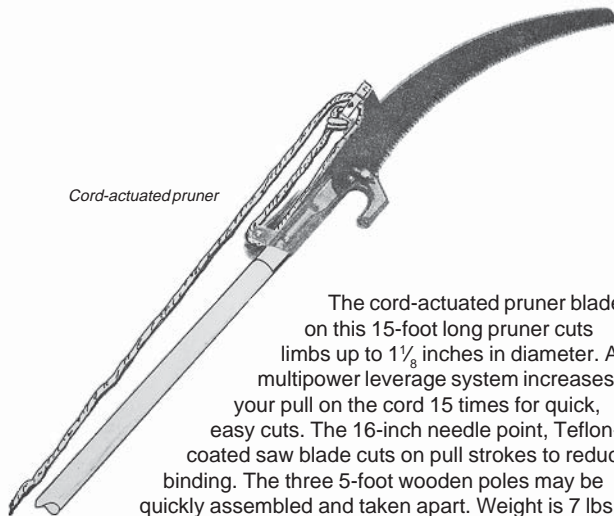

The cord-actuated pruner blade on this 15-foot long pruner cuts limbs up to 1 1/8 inches in diameter. A multipower leverage system increases your pull on the cord 15 times for quick, easy cuts. The 16-inch needle point, Teflon-coated saw blade cuts on pull strokes to reduce binding. The three 5-foot wooden poles may be quickly assembled and taken apart. Weight is 7 lbs.

Pole pruning saw

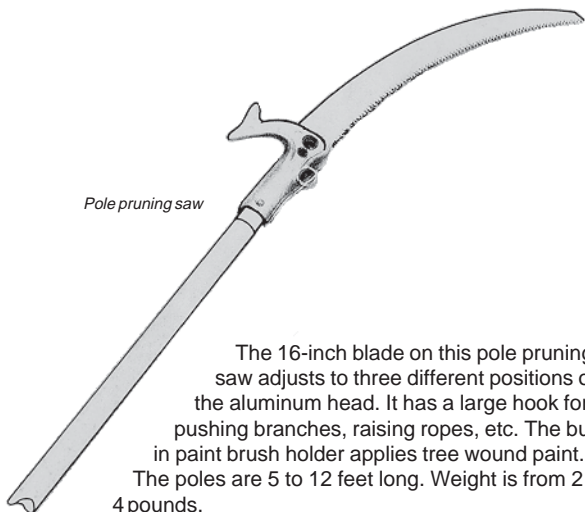

The 16-inch blade on this pole pruning saw adjusts to three different positions on the aluminum head. It has a large hook for pushing branches, raising ropes, etc. The built-in paint brush holder applies tree wound paint. The poles are 5 to 12 feet long. Weight is from 2 to 4 pounds.

Tree trimmer

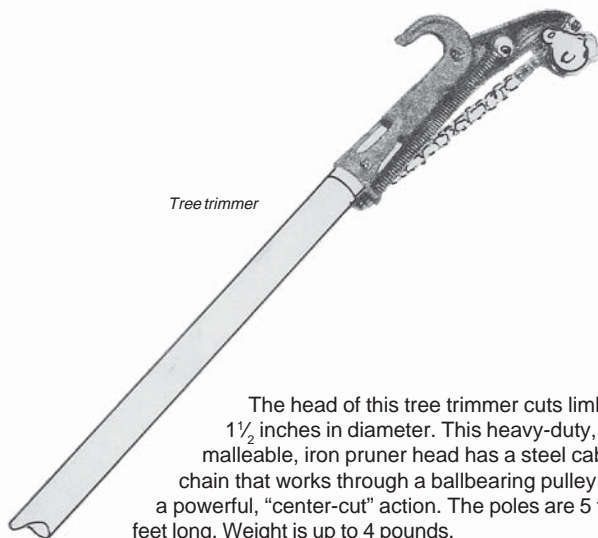

The head of this tree trimmer cuts limbs 1 1/2 inches in diameter. This heavy-duty, malleable, iron pruner head has a steel cable chain that works through a ballbearing pulley for a powerful, "center-cut" action. The poles are 5 to 6 feet long. Weight is up to 4 pounds.

Tree trimmer

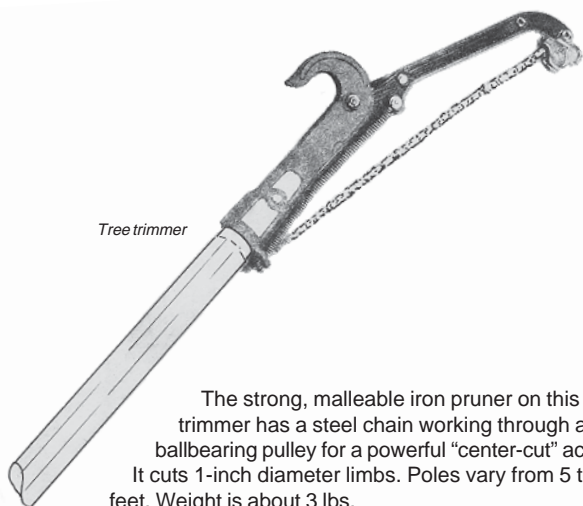

The strong, malleable iron pruner on this tree trimmer has a steel chain working through a ballbearing pulley for a powerful "center-cut" action. It cuts 1-inch diameter limbs. Poles vary from 5 to 12 feet. Weight is about 3 lbs.

Wedges

Use wedges as levers to prevent the sides of a cut from pinching a saw blade before the cut is finished. Most jobs require soft wedges that will not damage saw teeth. ABS plastic wedges are available in different lengths, widths, and weights. Some have metal inserts in the heads. Other types of wedges are designed to be used in combinations for felling. Wooden wedges are no longer used by the Forest Service.

Select the correct wedge for the job. Replace wedges when they become chipped or broken.

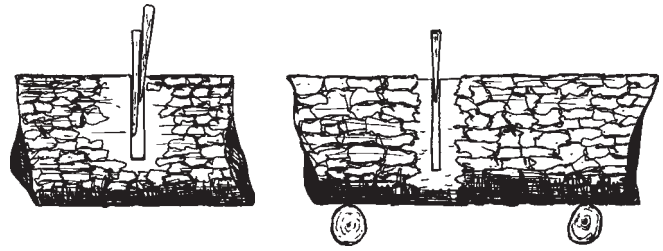

Using one or more wedges keeps a saw blade from being pinched.

Tools for Chopping

Axes

The ax is a traditionally American handtool that has been used from Colonial times. Different head patterns distinguish axes from different regions.

Axes are of two basic types—single or double bit. Single-bit axes have one cutting edge opposite a flat face. Double-bit axes have two symmetrically opposed cutting edges. The single-bit ax is used when safety is paramount. Some workers prefer the double-bit ax. One edge is maintained at razor sharpness and the other is kept somewhat duller for chopping around rocks or dirt. Mark the duller edge with a spot of paint.

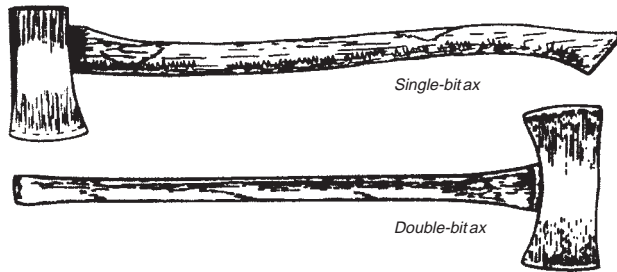

Modern axes incorporate many variations in handle length and head weights. Handles range from 32 to 36 inches, and heads from 2 to 4 pounds. A wide variety of head patterns is available. Broadaxes are used for hewing bridge timbers. If properly used and maintained, axes are effective for removing downfall, trimming limbs along a trail, and for felling. The flat end of a single bit may be used occasionally to pound stakes or wedges, but it is not designed for heavy use. Prolonged use for pounding will loosen the head, chip the face because it is not hardened like a hammer face, and warp the eye, causing problems with rehandling and balance.

Before chopping, check for adequate swing clearance and remove underbrush and overhanging branches that might interfere. Be sure your footing is stable and secure. Chop only when you are clear of other workers. Stand comfortably with your weight evenly distributed and both feet planted shoulder-width apart. Measure the correct distance to stand from the cut by holding the handle near the end and stretching your arms out toward the cut. You should be able to touch the blade to the cut. Begin chopping by sliding your forward hand within 6 inches of the head. As you swing, your forward hand slides back down the handle to the other hand. Just after impact, give the handle a slight twist to pop severed wood out of the cut.

SINGLE-BIT PATTERNS

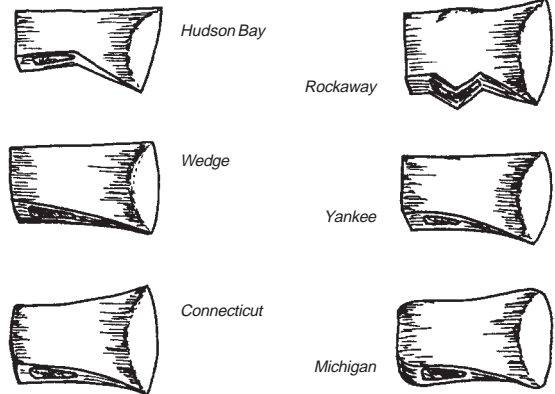

DOUBLE-BIT PATTERNS

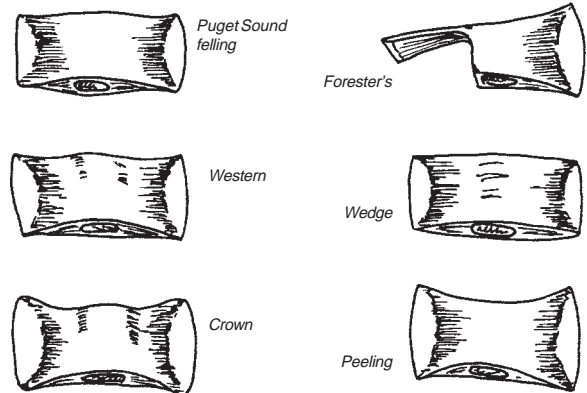

Ax head types.

Proficiency with axes requires practice. In general, the force of the swing is not as important as accurate placement. You should learn to “switch hit” with the ax, alternating your forward hand on the handle between chops while maintaining a firm grip with the other.

Always chop away from your body. Stand so a glancing blow won't strike you. If you must cut toward yourself, “choke up” on the handle with both hands and use short swings to give more control.

Chopping through a log requires a cut width twice the log's diameter to prevent the sides from converging before you are through. If opposing cuts are used, make each as wide as the log's diameter.

When limbing, cut on the underside of limbs and not in the crotch. Fewer chops are required and there is less chance that the ax will wedge between the branch and trunk or glance off. You are also more likely to chip blades because

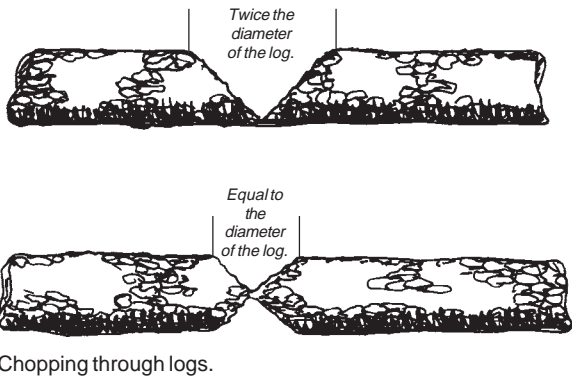

crotch wood is dense. When chopping branches above the crotch, place something solid under the chopping point to prevent the branch from springing back and slapping you.

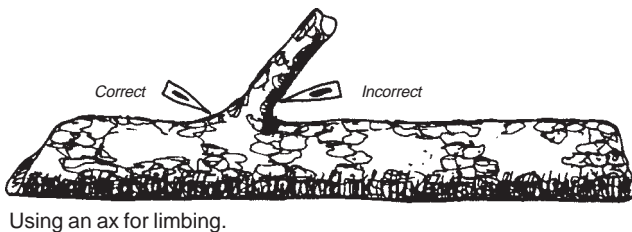

Carry axes by your side with the head forward. Grasp the handle firmly just behind the head and keep the cutting edge away from your body and down. Sheath all axes before transporting.

When sharpening, consider the job at hand. If you must reshape the blade, maintain the original shape as much as possible. Discard axes with poor profiles or cracked heads. Grind the blade slowly, arcing with the grinder toward the blade's midpoint so it has a full-width convex bevel. Be careful not to hollow grind blades, which produces a concave blade bevel the radius of the grinding wheel. Finish with a mill bastard file and an ax stone.

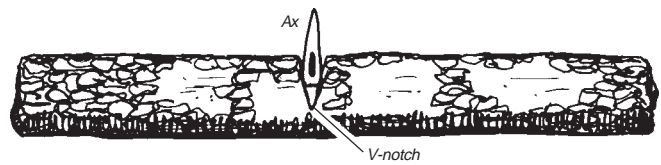

When sharpening in the field, secure the ax so both hands are free. A double-bit can be lodged in a tree stump or log, and a single-bit can be secured with the butt end in a V-notch. Wear gloves on both hands, and use a file guard on the file. Finish with an ax stone.

An Ax to Grind: A Practical Ax Manual (Tech. Rep. 9923-2823-MTDC), by Bernie Weisgerber, is a practical and detailed handbook about axes, their history, and their continuing use.

Hatchets

Many trail workers include hand axes or hatchets among their tools. Hatchets work well for trimming small green stems or freshening blaze markers along the trail. They are easily and safely carried in belt-mounted sheaths.

Hatchet heads are usually made of heat-treated steel designed to accept wood or fiberglass handles. Some have a steel handle forged to the head. They can weigh from 1 to 3 pounds and handles range from 10 to 16 inches long.



Use and maintain hatchets like regular axes. Remember that these tools are not designed for excessive pounding. Additional hazards may also exist for users because hatchets are single-grip tools.

Examples:

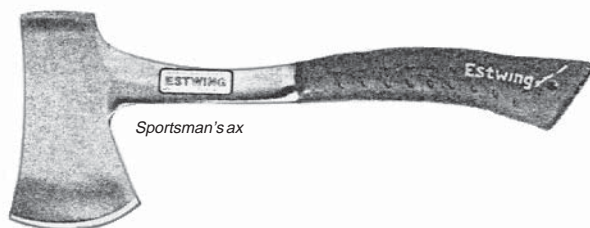

Sportsman's ax

A sportsman's ax has the blade and handle forged from one-piece steel. The length is 13½ inches and the blade is ¾ inches. Weight is 24 ounces.

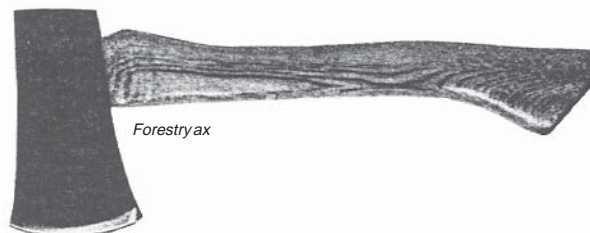

Forestry ax

The forestry ax has a 1¼-pound head, 14-inch hickory handle, and weighs 1¾ pounds.



Tree-sounding ax

The tree-sounding ax has a ½-pound head that is designed for "sounding" trees. Foresters like its small size (10 inches long; 2½-inch blade) for carrying in a vest or jacket pocket. Weight is 1 pound.

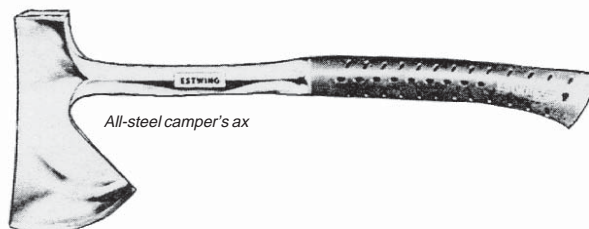

All-steel camper's ax

An all-steel camper's ax is 16 inches long and is forged from one-piece steel. It has a 4-inch blade, and weighs 2¾ lbs.

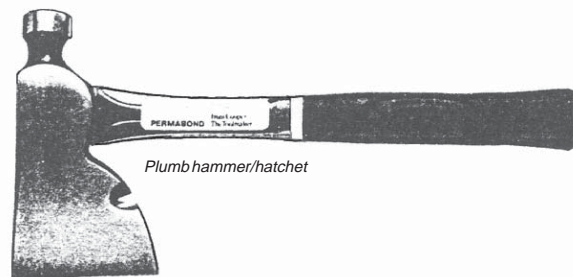

Plumb hammer/hatchet

A plumb hammer/hatchet is a half-hatchet with hardened, tempered bit and a strong fiberglass handle. It has a 3- to 4-inch bit, is about 13½ inches long, and weighs 2½ lbs.

Tools for Grubbing

Pulaskis

The Pulaski combines an ax and a grub hoe into one multipurpose firefighting tool. Pulaskis adapt easily to trail work, especially for crews limited to a few tools, or crews with only a general idea of the job to be done. Combination tools are less effective than single purpose tools. An ax balances better and chops more safely and grub hoes are more efficient than Pulaskis. Pulaskis weigh about $5\frac{1}{2}$ pounds. Most have a 36-inch handle.

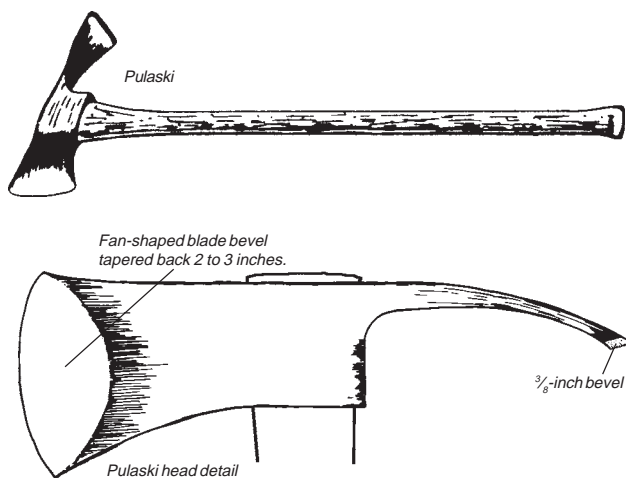

When using the hoe, stand bent at the waist with your back straight and parallel to the ground, knees flexed, and one foot slightly forward. Hold the handle with both hands so the head is at an angle to your body, and use short, smooth, shallow swings. Let the hoe hit the ground on its corner. Use the ax end to chop large roots after the dirt has been cleared by the hoe. Always wear safety goggles while grubbing to guard against flying chips of rock and dirt.



Use short strokes and let the hoe hit the ground on its corner.

Carry the Pulaski at your side. Grip the handle firmly near the head and point the ax end away from your body and down. Sharpen the cutting edge like an ax. When sharpening the hoe, maintain the existing inside edge bevel. Never sharpen the top of the hoe.

CombiTools

The combination or combi tool is basically a military entrenching tool on a long handle. It functions as a hoe, pick, or shovel. These tools have recently been developed to aid Forest Service firefighting crews. Because of their wide blade and longer handle, most users have found them less fatiguing to use than traditional tools.

Use, carry, and maintain the tool as you would a Pulaski or McLeod.



Combination (or Combi) tool developed for firefighting, is popular for trail work.

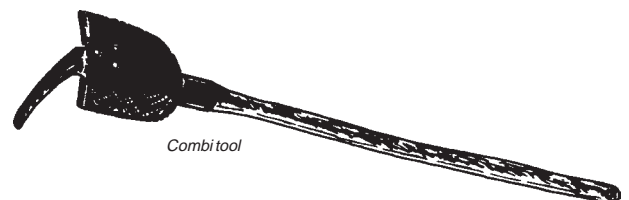



The combi tool serves as a hoe, pick, or shovel.

McLeods

The McLeod combines a heavy-duty rake with a large, sturdy hoe. McLeods work well for constructing trails through light soils and vegetation or for reestablishing tread along sloughed side cuts. They are inefficient in rocky or unusually brushy areas. The hoe edge is about $9\frac{3}{4}$ inches wide, the six rake teeth are $3\frac{1}{2}$ inches long, and the handle is 48 inches long. Weight is about 5 pounds.

Carry McLeods like shovels with the head forward and the handle behind. Grip the handle firmly near the head and hold it away from your body while you walk. Sharpen the hoe with a mill bastard file. Maintain a 45° outside edge bevel. Honing the edge with a whetstone is unnecessary. Rake tines sometimes bend and should be straightened, but they are not sharpened.

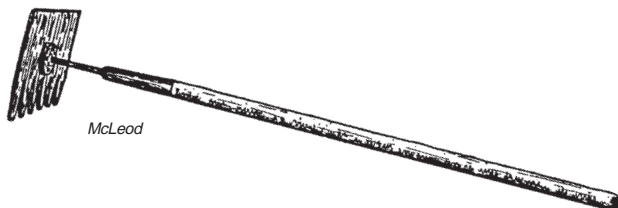

Picks

Pick heads have a pointed tip for breaking hard rock by forcing a natural seam. They also have a chisel tip for breaking softer materials. Picks commonly weigh 5 to 10 pounds and most have 36-inch handles.

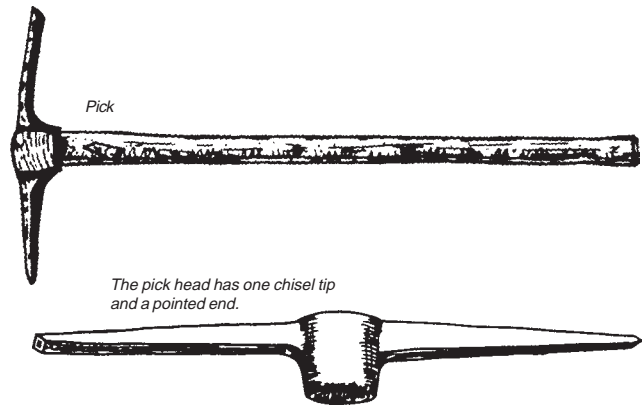

When using a pick, stand comfortably with your feet about shoulder-width apart and one foot slightly forward. Grasp the handle with your forward hand near the head; place the other hand near the handle end. Bending over at the waist and keeping your back straight and parallel to the ground, work the pick like a Pulaski hoe with short, deliberate, downward strokes. Avoid raising the pick overhead while swinging; this wastes energy and creates a safety hazard because the heavy, narrow tool head cannot be easily controlled or directed. *Always* wear safety goggles while picking to guard against flying chips of rock.

An oval-tapered eye and handle end cause pick heads to tighten when swung, but allow a worker to remove handles for carrying and sharpening. Sometimes a small screw is screwed into the handle just below the head to prevent slipping. Before sharpening, secure the tool head to free both hands. Use a grinder or mill bastard file to sharpen pointed tips to $\frac{1}{8}$ -inch square. When sharpening chisel tips, maintain the factory bevel.

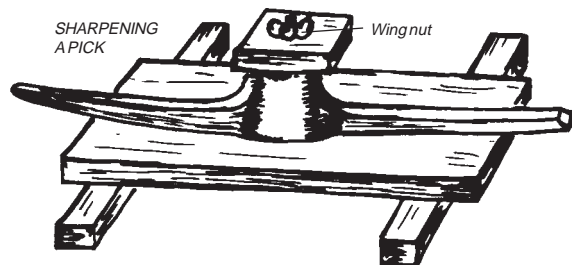

Secure the head to the frame by placing a bolt through the eye of the head and fastening it with a wing nut. This allows for easy removal and keeps both hands free for sharpening.

Mattocks

The *cutter mattock* uses the same grubbing blade as pick mattocks, but includes an opposing 2-inch cutter blade instead of a pointed tip. Crews working in deep, rooty soil often prefer these tools; roots are severed with the cutter blade and then pried out with the grubbing end. Follow the use instructions outlined for Pulaskis.

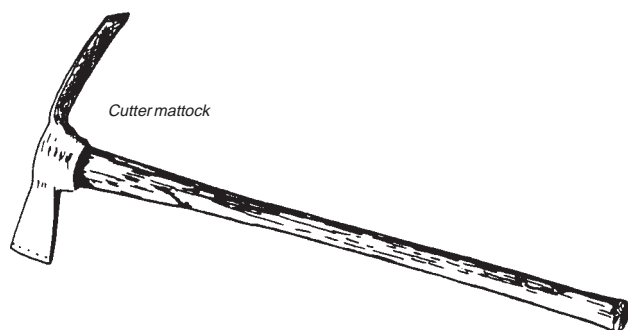

The *pick mattock* is often recommended as the standard tool for trail work. It is used like a pick. It has a pointed tip for breaking rocks and a grubbing blade for working softer materials. The grubbing blade may also be used to cut roots or remove small stumps. Moreover, with the edge of the tool, you can tamp dirt and loose rocks or smooth a new tread, and the handle helps measure the trail's width.

Mattock handles are similar to pick handles. They are usually 16 to 17 inches long and they can be removed when transporting and sharpening the heads. Mattocks weigh about 2½ pounds.

Maintain good cutting edges on mattocks. Keep grubbing blades sharpened to maintain a 35° edge bevel on the underside. Sharpen pick ends like a pick, and maintain factory bevels on cutter blades.



Types of mattocks.

Adze, Grub, and Hazel Hoes

Use adze hoes, grub hoes, or hazel hoes to break sod clumps when constructing new trail or leveling an existing trail tread. These hoes are also useful in heavy duff. Operate hoes like Pulaskis, mattocks, and picks. Work the tool at an angle across the front of your body so the handle is not between your legs. Bend at the waist, keeping your back straight, knees flexed, and feet shoulder-width apart with one foot slightly forward. Control the swing by grasping the handle near the end with one hand and near the middle with the other. "Choking" the handle and swinging straight down may cause the handle to hit your shins or knees. Use short, shallow chops to save energy. Strike so the tool hits at an angle on its corner.



Adze hoes are useful tools for constructing trails.

The tapered eyes and handle ends of these hoes force heads to tighten during use, but make them easily removable for carrying and sharpening. Like picks and mattocks, you can also use a screw to hold the head from slipping on the handle. To sharpen, remove the handle, secure the head so both hands are free, and use a file or grinder to bring the cutting edge to an inside bevel of 45°. Carry these hoes like Pulaskis, picks, or mattocks.

Tools for Grubbing

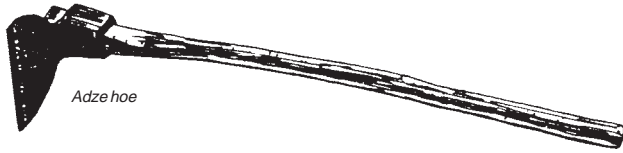

Adze hoe

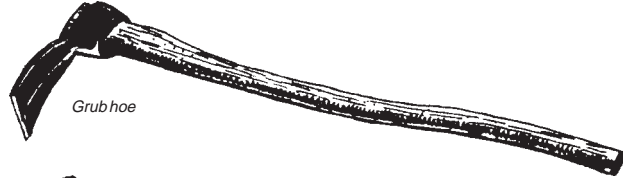

Grub hoe



Hazel hoe

Draw or swan neck hoes are useful for leveling or weeding. These hoes are light duty tools, however, and may often prove impractical for trail use. Carry draw hoes like shovels, with the sharpened edge away from the body and down. Sharpen the edge to an outside bevel of 45°. Finishing with a whetstone is unnecessary for all hoes.

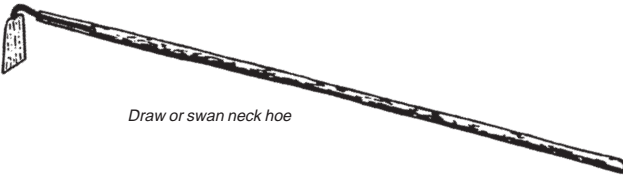

Draw or swan neck hoe



Grub hoe being used for trail work.

Tools for Digging and Tamping

Shovels

Shovels are available in various blade shapes and handle lengths. In general, shovel blades are tapered for shifting loads, square-edged for scooping, or pointed for digging. Handle lengths vary from D-handles of about 27 inches to longer-handled shovels up to about 48 inches. They weigh from 3 to 5 pounds. Long-handled shovels are usually preferred for trailwork. A shovel with a detachable handle is often a good choice. Firefighters use a shovel with a detachable handle that is designed to scrape combustible material down to mineral soil. It is lightweight and durable and well-suited for scraping as opposed to digging.

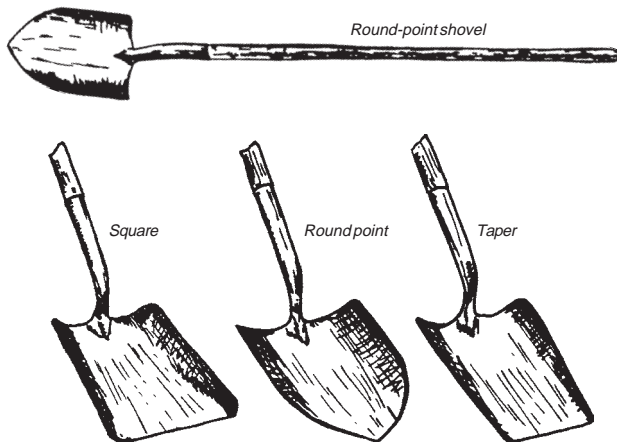

Shovel types.



Press your arm against your thigh to gain leverage.

When shifting or scooping materials, bend your knees and lift with your legs—not your back. Use your thigh as a fulcrum to push against the shovel. This makes the handle an efficient lever and saves your energy and your back. When digging, make the top diameter of the hole large enough so that it won't interfere with the shovel handle while removing loose dirt as the hole deepens. A shovel used with a pick or bar is most effective; picks or bars make prying with the shovel unnecessary. Wiggling the shovel handle while applying foot pressure on the blade will help you dig deeper.

Carry shovels with the head forward and the handle behind. Grip the handle firmly near the head and hold it away from your body while you walk. Sharpen blades with a mill bastard file. Start filing the edge just below the foot rest and work to the point. File away from blade

center. Maintain the bevel on the inside (top) surface of the blade approximately at a 45° angle. Sharpen square-edge and tapered-edge shovels on the bottom only. Final honing is unnecessary.

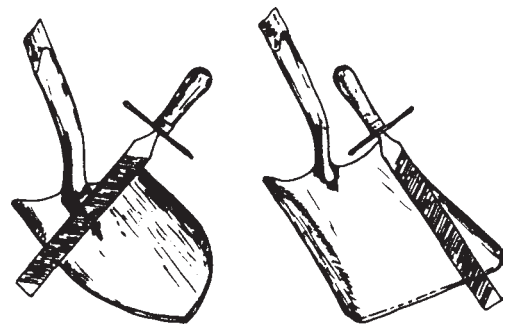

Sharpening square-edge and taper-edge shovels.

Digging and Tamping Bars

A digging and tamping bar is about the same length as a crowbar, but much lighter. It is designed with a chisel tip for loosening dirt or rocks and a flattened end for tamping. These bars are not prying tools. Bars are approximately 70 inches long with a 2½-inch-wide tamping end.

Carry digging bars at their balance point, like shovels or crowbars. Maintain bars by keeping them as straight as possible and by sharpening the chisel tip to retain the factory bevel.



Digging and tamping bar

Tools for Brushing

Lopping and Pruning Shears

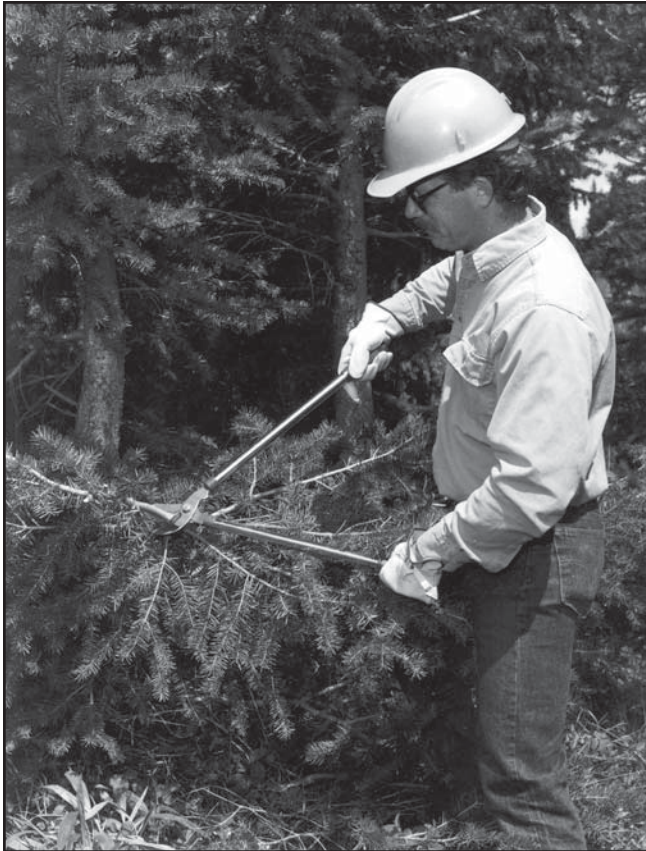

Lopping shears allow branches to be cut cleanly and flush with tree trunks.

Lopping and pruning shears are similar in design and use, although lopping shears have longer handles to improve reach, and gear drives to increase leverage for thicker stems. Cutting edges vary, but generally one blade binds and cuts a stem against an anvil or beveled hook. We recommend the hook and blade shear for overhead cuts because the curved blades transfer the weight of the shears to the limb. Quality shears have rust-resistant steel blades. Handles are wood or aluminum. Handles range from 26 to 36 inches long. Limbs up to 3 inches can be cut with shears.

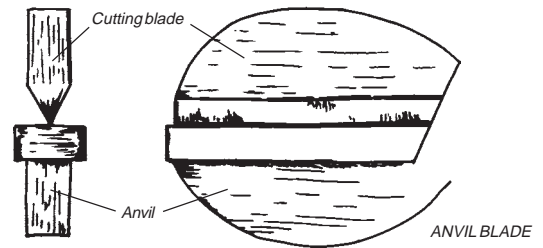
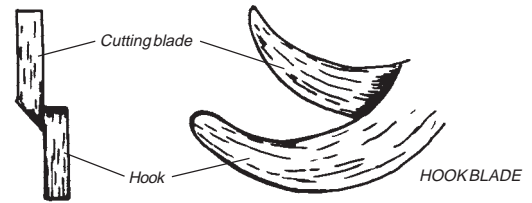
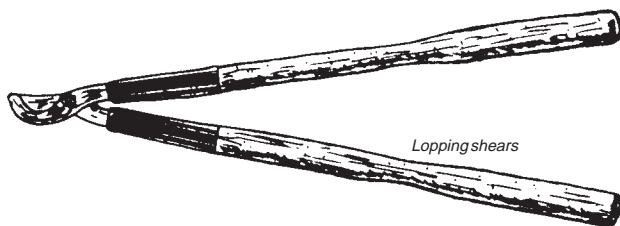

Hook and anvil cutting blades.

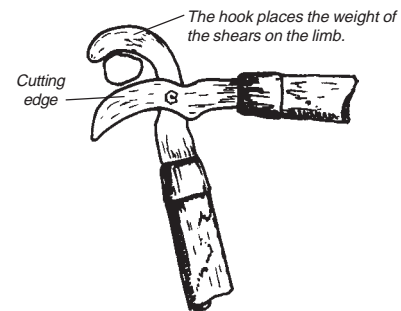

Lopping shears

Transport shears with the blades closed. Grip the tool on one handle just behind the blade and carry it by your side. Clean moisture and sap from blades after use. Keep metal parts lightly oiled to prevent rust. Frequently check nuts and bolts for tightness, and always carry replacements in the field.

To sharpen, spread the handles apart, resting one or both ends on a flat surface. Use a mill bastard file on the cutting blade only; neither hooks nor anvils are sharpened. Maintain factory bevels while filing toward the cutting edge. Use a whetstone to remove the wire edge.

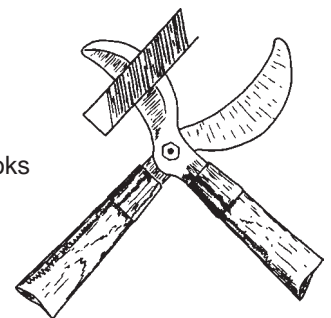

Sharpening lopping shears.

Examples:

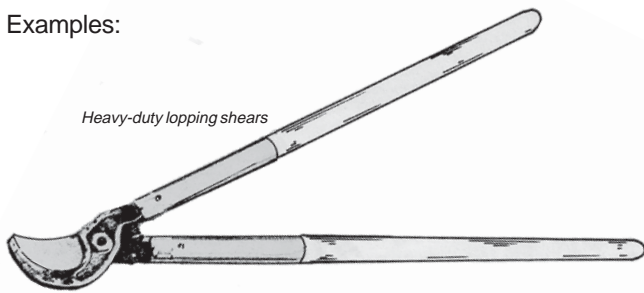

Heavy-duty lopping shears

Heavy-duty lopping shears are ideal for the forester. They have ash handles, make a 3-inch diameter cut, and are 37½ inches long. Weight is 5½ pounds.

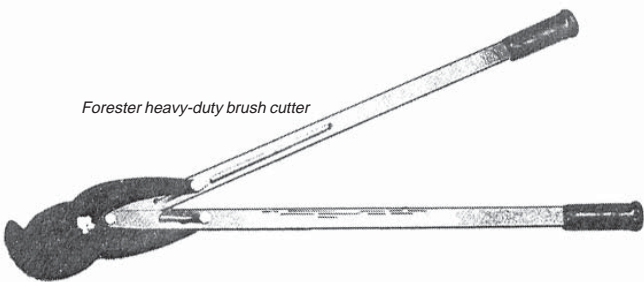

Forester heavy-duty brush cutter

"Forester" heavy-duty brush cutters make a 2-inch diameter cut for heavy-duty jobs—hardwood, deadwood, branches, or brush. The rugged steel construction is even strong enough to dehorn and clip cattle. Both blades cut to reduce bark damage. The shears are 27 to 34 inches long and weigh 4 to 8 pounds.

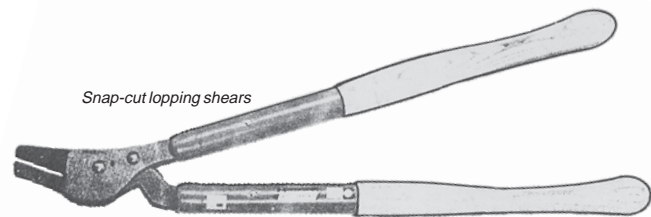

Snap-cut lopping shears

Snap-cut professional lopping shears make a 1¾-inch diameter cut. They are a gear-driven lopping shear with tremendous cutting power—10 pounds force applied to the handles gives 300 pounds of cutting power. The shears are 30 inches long and weigh 5½ lbs.

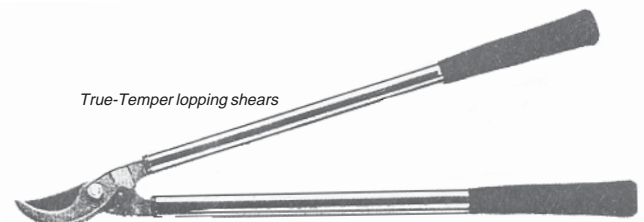

True-Temper lopping shears

True-Temper lopping shears give a 1½-inch diameter cut. The tubular steel handles provide extra strength and the rubber cushion grips absorb shocks. These are used by biologists to remove deer jawbones. The shears are 26 inches long and weigh 2¼ pounds.

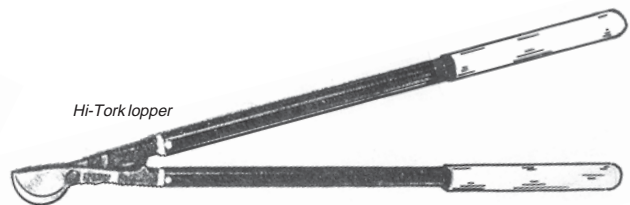

Hi-Tork lopper

The Hi-Tork lopper makes a 1½-inch diameter cut. It is designed for hardwood, frozen wood, brush, and deadwood. The shears are 27 inches long and weigh 3 pounds.

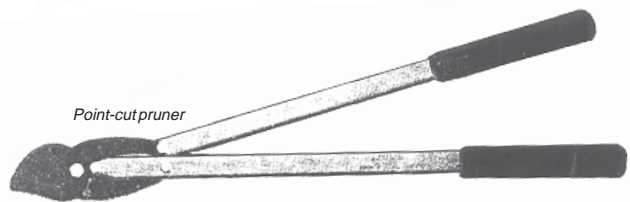

Point-cut pruner

Point-cut pruners make a 1¼-inch diameter cut. The blades open wide to cut suckers or sprouts at blade point. Weight is 3 pounds.

Bank Blades and Bush Hooks

Bank blades and bush hooks are designed specifically for cutting through thickets of heavy brush or saplings. Their long handles and heavy heads will add momentum to the force of your swing, but their curved blades also pose extra safety hazards. Always maintain a firm grip with both hands on the handle. Cut with a slicing rather than a hacking motion. Remember that bank blades have cutting edges on both edges of the blade. Stay clear of other workers. Be aware of the increased possibility of glancing blows, and always control the swing to avoid cuts to the legs or feet. Wear shin guards when operating these tools. Blades are available in 12- to 16-inch lengths. Handles are 36 inches or 40 inches long. The tool weighs from 3½ to 5 pounds.



Bank blade



Bush hook

Carry bank blades and bush hooks with the head forward like a shovel. Grip the handle near the head and hold the hook away from the body and down.

Sharpen bank blades and bush hooks with a mill bastard file and finish with a whetstone. Always wear your gloves and use a file guard. Stroke along the straight edges of the blades and swing the stone or file in an arc to maintain the factory edge bevel on curved sections.

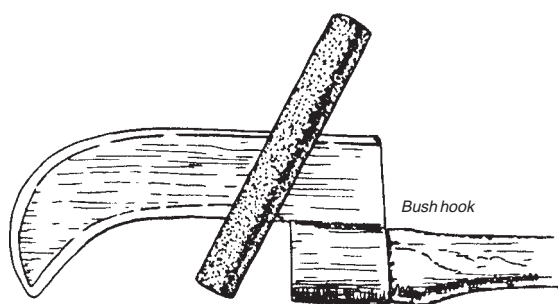

Sharpening a bush hook.

Examples:

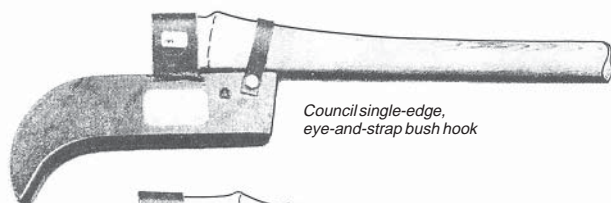

Council single-edge,
eye-and-strap bush hook

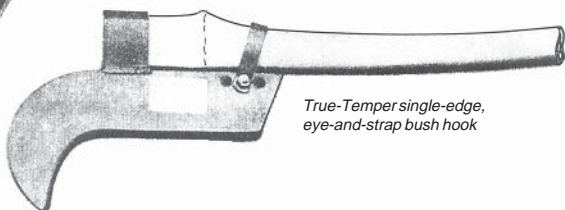

True-Temper single-edge,
eye-and-strap bush hook

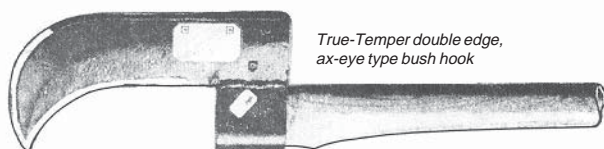

True-Temper double edge,
ax-eye type bush hook

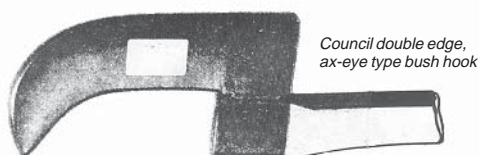

Council double edge,
ax-eye type bush hook

Bush hooks are used for clearing work that is too heavy for a scythe and not suited for an ax. They are available with single-edged, eye-and-strap blade, or double-edged, ax-eye blade type. They have hickory handles 12 to 36 inches long and weigh 2 to 4½ pounds.

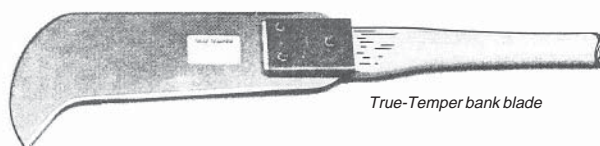

True-Temper bank blade

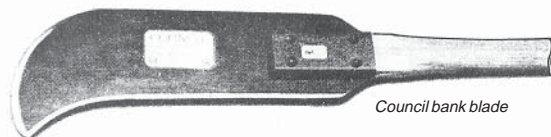

Council bank blade

Bank blades are used for clearing thick undergrowth and brush. The blade is sharpened on both sides. Blade lengths may be 12 or 16 inches. Hickory handles are available in 36 or 42 inches. These tools weigh 1 to 5½ pounds.

Clearing Knives and Swedish Brush (Sandvik) Axes

These clearing tools work well in brushy thickets or when clearing in rocky or confined areas. Clearing knives look like small, short, brush hooks, so use, carry, and sharpen them accordingly. Handle length will determine if the tool is operated one- or two-handed. Use and carry a short-handled clearing knife like a machete.

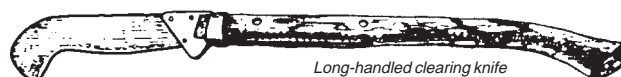

Long-handled clearing knife

Brush axes have different blades than clearing knives. The replaceable Swedish steel blade has a 5½-inch cutting edge. The ax has a 27-inch long handle. It weighs about 2½ pounds. They have removable blades held in a C-shaped frame under tension. Tension may weaken and cause blades to pop out. Bend the frame outward slightly to increase tension. The blade can be removed for sharpening. Avoid overheating the blade and losing the temper. Replace badly damaged blades.



Swedish brush (Sandvik) ax

A Swedish brush ax cuts small saplings and brush easily, safely. The replaceable Swedish steel blade has a 5½-inch cutting edge. The hickory handle is 27 inches long overall, and weighs 2½ pounds.

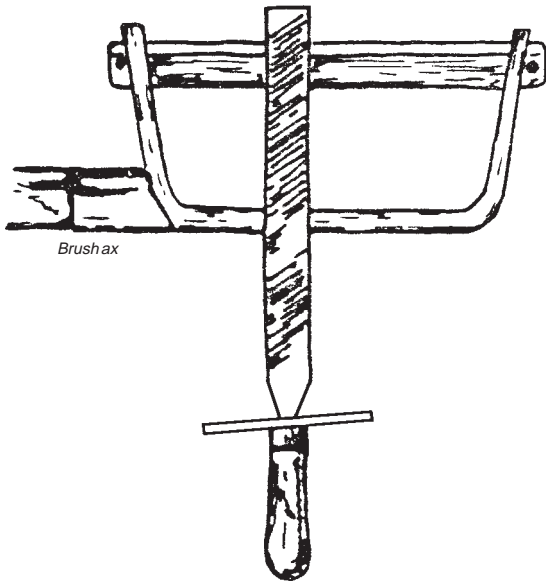

Brush ax

Sharpening the brush ax.

Because these are single-grip tools, a worker must always maintain a firm grip while swinging. Also, be aware of the location of fellow workers. The hook on the end of the Woodsman's Pal can slip as it is pulled toward you and cut legs or hands, or it may strike the back of an operator's head on the back swing. Both tools come with belt sheaths that make them easy and safe to carry.

When sharpening, use a mill bastard file or whetstone to maintain the factory edge bevel. Sharpen the hook of the Woodsman's Pal using the procedure described for the brush hook. Protect sharpened edges at all times.

Examples:



Collins machete

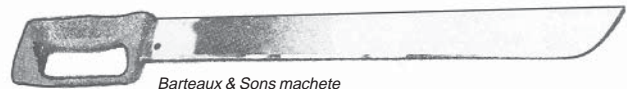

Barteaux & Sons machete



Seymour machetes



The Seymour machetes are for cutting heavy weeds, brush, vines, grass, and shrubs. They have heavy-duty, hand-forged Swedish steel blades and polypropylene safety handles that are 17 to 24 inches long. Weight is a few ounces to 2 pounds.

Machetes and Woodsman's Pals

Machetes and Woodsman's Pals are used to clear weeds, brush, and small trees along a trail. Machetes became commonly used in Forest Service work after World War II when surplus knives were used extensively for brushing. Machetes have blades from 17 to 24 inches long and weigh up to 2 pounds. The Woodsman's Pal is shorter and sturdier than the machete and includes a cutting hook and a knuckle guard. It is used for cutting, chopping, digging, hacking, and pulling. It is 16 inches long and weighs about 1½ pounds.

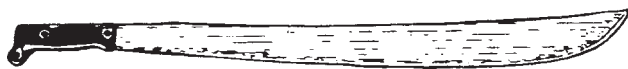

Machete



Woodsman's Pal

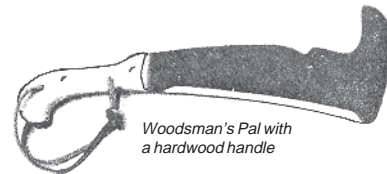

Woodsman's Pal with a hardwood handle

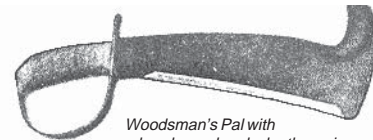

Woodsman's Pal with a hand guard and a leather grip

Woodsman's Pal axes are used for cutting, chopping, digging, hacking, and pulling. They are 16 inches long and weigh 1½ pounds.

Corn Knives

These tools, also called tobacco knives, come in a variety of shapes and sizes. They are commonly used for hand brushing on tree and tobacco plantations.

Corn knives are single-grip tools, so hold tightly to the handle while operating. Stand well balanced and bend at the waist. Use your free hand to steady the stems you intend to cut. Wear a glove to protect your free hand from scratches or burns from weeds.



When carrying, grip the knife on the handle near the blade. Carry the tool by your side with the blade pointed away from your body and down. When sharpening, maintain factory edge bevels. Corn knives may have curved blades that are sharpened on only one side like brush or weed hooks, or they may have straight or adjustable blades that are sharpened on both sides like machete.

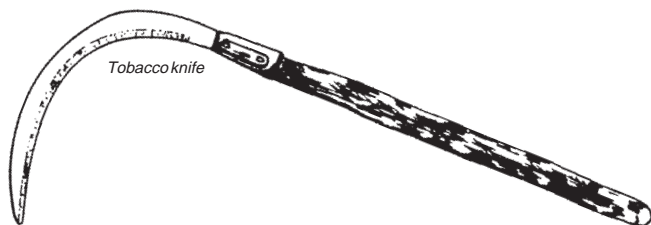

The tobacco knife blade is tough alloy steel that is 12 inches long by 1 inch wide and $\frac{3}{32}$ -inch thick. It is beveled and sharpened with an ax stone only on one side. The round hardwood handle is $1\frac{1}{4}$ inches in diameter.

Scythes

Scythes efficiently mow open areas of weeds or grass. *Grass* or *weed scythes* have 24- to 40-inch blades and long handles. *Brush scythes* have shorter, sturdier blades and handles and are often preferred by trail crews.

Operate the scythe by grasping the handles (nibs) projecting from the bar (snath) and rhythmically sweeping the blade low to the ground across and in front of you. A "grass nail" placed between the bar and the blade keeps vegetation from catching in that junction.

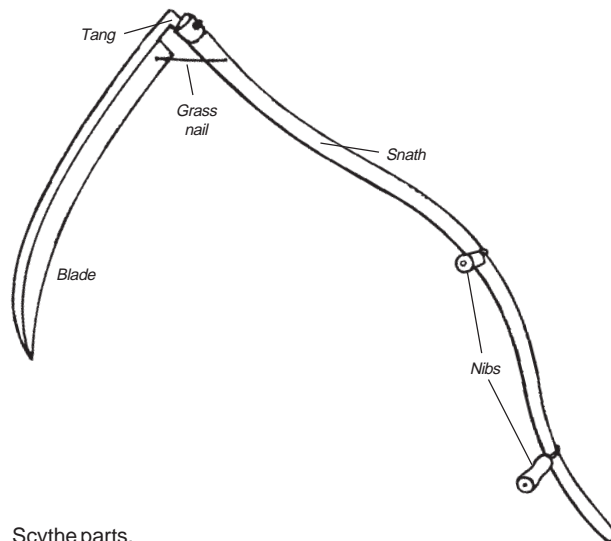

Scythe parts.

Carry scythes by your side in one hand, blade forward and handle behind. Keep control of the blade by grasping the handle near the blade and pointing the blade away from your body with the tip down. Stop and change hands if the tool becomes too heavy. Transport scythes well behind a line of workers, and work only in areas clear of others.

Before sharpening the scythe, stand the handle on its end so the blade is horizontal and the tip points down. Use a whetstone or scythestone to hone the blade from back to front (tang to tip) on both sides. Maintain the factory edge bevel. If the blade is badly chipped detach it from the handle and reshape it with a grinder or file. Return the edge to a bevel of 10° . Although some argue that the wire edge facilitates cutting light vegetation, we recommend removing it. A lesser known method of sharpening involves beating the blade with a special hammer to shape and sharpen it without grinding. Finish with a whetstone.

Sickles and Grass Hooks

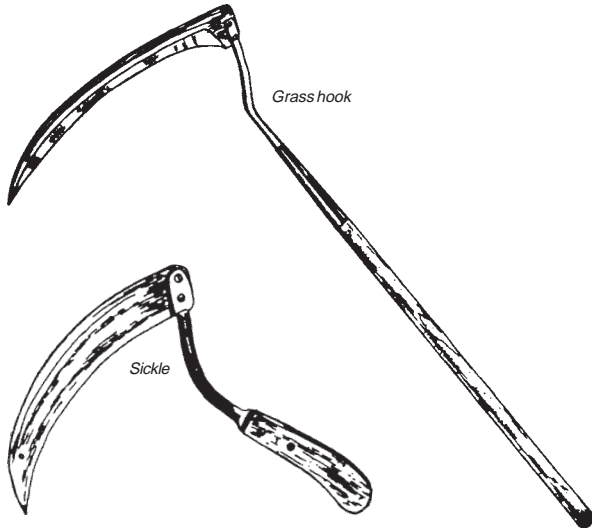

Sickles are curved knives used to cut weeds or grass in limited space. The single grip handle angles upward so the blade cuts parallel to the ground while the operator stands bent at the waist. The blade is 12 inches long and the handle is 4 to 5 inches long.

Carry the sickle by your side with the cutting edge away from your body and pointed down. Maintain a firm grip on the handle when carrying or using.

Maintain sickles with a whetstone or scythestone. The blade is beveled on the top side only. Remove the wire edge by working the stone flat against the backside.

The grass hook combines features of scythes and sickles. It can be operated like a scythe from an upright position, but the small blade is maintained like a sickle.

Weed Hooks

Workers can easily trim annual vegetation along a trail with a weed hook. These tools have a curved inside blade that cuts by pulling through stems toward the operator and a straight top blade that cuts by pushing. Long handles allow the operator to remain upright.

Since these tools are light enough to operate with a single grip, carry them by the handle with the head away from the

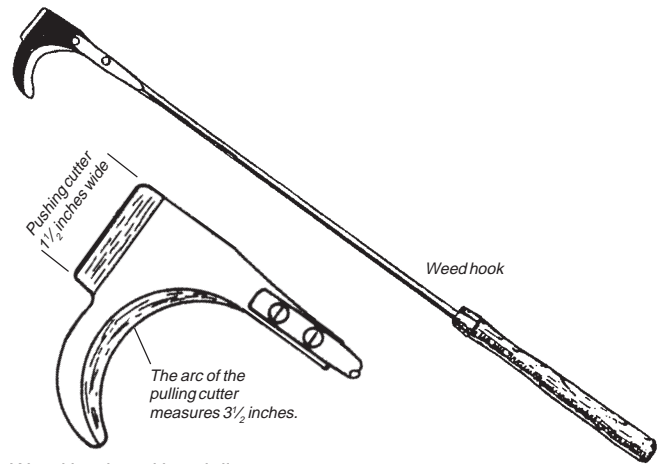

Weed hook and head diagram.

body and down and weed as you walk. Always maintain safe distances between workers. Remember that the tool has two cutting edges and that swinging it could be especially hazardous. Sharpen weed hooks with a mill bastard file and finish with a whetstone. Use a curving stroke on the pulling cutter that follows the inside edge around to the tip. Sharpen the pushing cutter on the top side only.

Weed Cutters (Grass Whips)

Weed cutters are used for cutting light growth like grasses and annuals that grow along trails. They are lightweight and durable and usually swung like a golf club. The sharper the blade, the less energy needed to cut. Both edges are serrated and cut on the forward and return strokes. When sharpening the edges of these tools, remember that different models have the blade bevels on different sides. The frame may interfere when sharpening top-beveled blades. It may be best to remove the blade and screw it to a block of wood for sharpening. Maintain a 25° bevel on both serrated and straight blades. Cutters usually have a 9- by 2-inch blade and a 40-inch long handle.

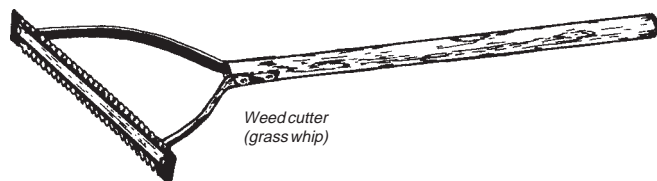

T ools for Pounding and Hammering

Sledge Hammers

Sledge hammers have heads that weigh from 8 to 20 pounds, which are forged from heat-treated high carbon steel. They usually have two rounded striking faces with beveled edges to minimize chipping. Thirty-six inch handles are common. Handles can be fiberglass or wood.

Driving sledges are used to set heavy timbers and drive heavy spikes or hardened nails. *Stone sledges* are used to break boulders or concrete. Because of differences in tempering, these tools are not interchangeable.

Swing sledge hammers carefully—more like mattocks and picks than axes. Carry these tools like axes, holding the handle by your side, extending the handle behind you, and gripping the hammer near the head.

Maintain hammers by keeping striking faces smooth. Use a grinder, but do not allow the tool to overheat, which will weaken its temper. The temper is shallow, and excessive grinding will go through to soft metal. Have a blacksmith recondition those with badly chipped or mushroomed faces. Check handles regularly for tightness or cracks. Repair or replace them as needed.



Single jacking.

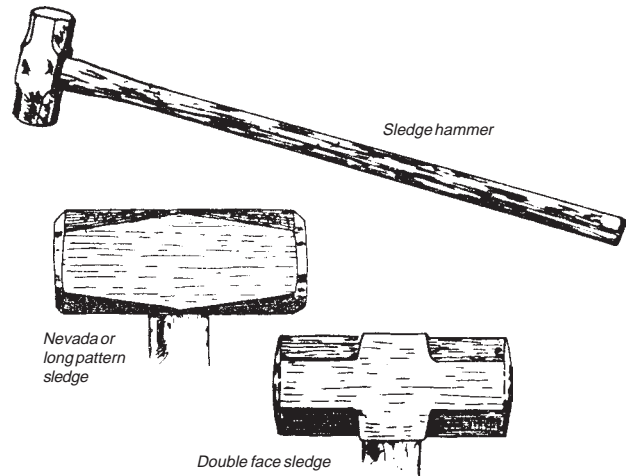

Hand-Drilling Hammers

Hand-drilling hammers are used to drill steel into rock or to drive wedge and feathers into cracks or drilled holes. There are two types of hand-drilling hammers—*single jacks* and *double jacks*. Both have two rounded striking faces with beveled edges to minimize chipping.

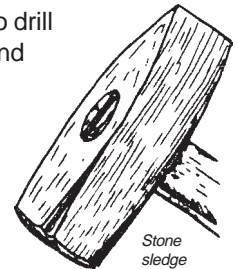

Single jacking involves an individual holding a drilling steel in one hand and hitting it with a hammer held in the other. The single jacks have 3- or 4-pound heads and 10-inch handles. The short handle helps you place blows accurately and resists breaking better than longer handles. Engineer's hammers with 3- or 4-pound heads and 14-inch handles can also be used for modified *double jacking*. An operator sits or kneels near the steel and hammers with both hands while another worker holds the steel. The proximity of both hands to the head required by the 14-inch handle assures that accuracy and safety are not sacrificed. Large double jacks with 6- or 8-pound heads and 36-inch handles are available for experienced drillers. For more information on hand drilling, we recommend

Hand Drilling and Breaking Rock (Missoula Technology and Development Center

Technical Report No. 8423-2602-MTDC, August 1984).



Features of Hand-Drilling Hammers—

Head The double-face hammer head is made of heat-treated, high-carbon steel.

Striking faces The two striking faces should have beveled edges and should be heat-treated.

Handle Wood handles are usually made of hickory. They should have a tight, knot-free grain that runs parallel to the wedge slot. Other handles are made of fiberglass, or are a forged extension of the head.

Single jack These are also called ‘club’ or hand drilling hammers. Handles are commonly 10 inches long, and heads weigh either 3 or 4 pounds. The short handle is uniquely suited to hand drilling because it resists breaking better than longer ones, and it facilitates accuracy by requiring the hand to be close to the head.

Engineer’s hammer These are also called long-handle single jacks. They come with a 14-inch handle attached to a 3- or 4-pound head, and work well for the drilling technique we call modified double jacking.

Double jack These large driving sledges have 36-inch handles and 6- or 8-pound heads. Because their use requires considerable expertise from both the driller and holder, we recommend that you use single jacking or modified double jacking until safety and proficiency with the double jack can be assured.

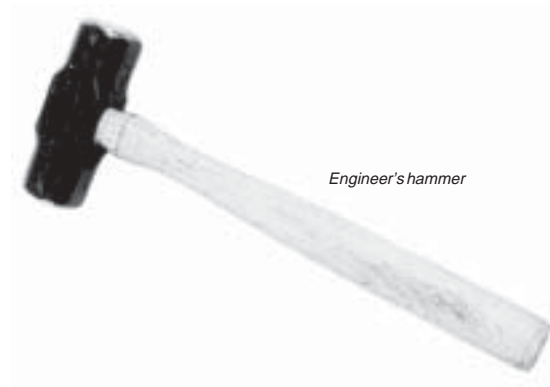



Double jacking.

Carry single jacks like hatchets and double jacks like axes or Pulaskis. Always wear gloves on the hands holding the steel to prevent injury from a glancing blow. Both drillers and holders should wear safety glasses or goggles to guard against flying rock chips.

Maintain drilling hammers by grinding striking faces smooth. Avoid overheating and excessive grinding with electric grinders that will destroy the shallow temper of the striking faces. If faces are badly chipped or unevenly worn, have them reconditioned by a blacksmith. Check handles regularly for tightness or cracks, and repair or replace them as needed.

Nailing Hammers

Nail hammers have heads with a heat-treated steel face for driving nails, and claws on the other end for pulling. Heads vary in weight from 7 to 28 ounces. Impact handles are hickory, fiberglass, or steel forged directly to the head. Handles are usually 12 to 14 inches long.

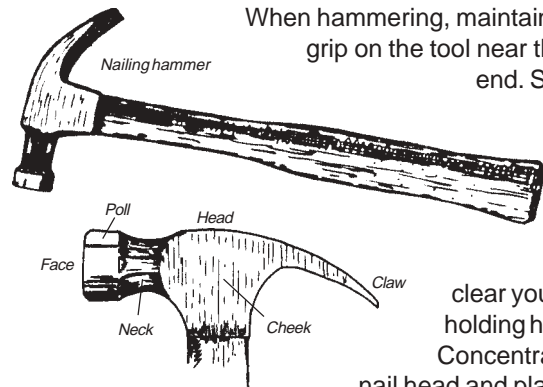

When hammering, maintain a secure grip on the tool near the handle end. Start nails

with light hits until you can

clear your nail-holding hand.

Concentrate on the nail head and place each hit carefully. When

removing nails, position the head upside down against a flat surface, and catch the nail head between the claws. Pulling the hammer toward you causes the head to rock the claw end up and extracts the nail. For larger nails, a block placed between the head and the surface will increase your leverage. To carry hammers, grip the handle near the head, holding the tool away from your body as you walk. Maintain them like the other hammers discussed in this section.

Tools for Lifting and Hauling



Use small rocks or logs for leverage when prying heavy objects.

Crowbars



Use a crowbar for prying and levering large, heavy objects. These bars are heavy-duty steel and vary in length, weight, and diameter. In general, crowbars have a chisel tip on one end and a rounded handle on the other. They are usually 1 to 1½ inches in diameter and vary between 40 to 62 inches in length.

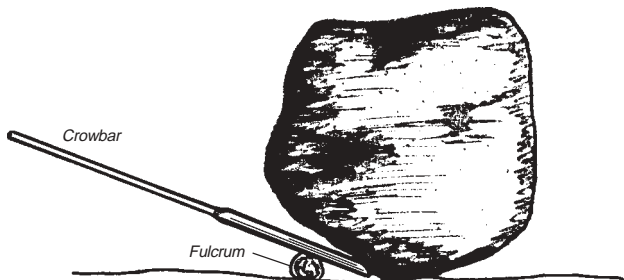

Crowbars are indispensable for moving very heavy objects.

Place the chisel tip under an object to be moved, and wedge a log or rock between the bar and the ground to act as a fulcrum for the lever. Press the handle down with your body weight positioned over your palms. Never straddle the bar when prying. When the object raises as much as the bite will allow, block it and use a larger fulcrum or shorter bite on the same fulcrum to raise it further. You will gain proficiency with practice.

Carry crowbars by your side, tip forward, and grip it tightly near the middle to maintain balance. Maintain the factory bevel on the tip with a file or grindstone.

Block and Tackles

A block and tackle is a set of pulley blocks and ropes used for hoisting or hauling. These come in different styles, sizes, and capacities. In general, however, the more ropes that pass between the blocks, the greater mechanical advantage the tool affords. This advantage is called stress strength or lift capacity and is usually stamped somewhere on the tool. Attempting to move objects heavier than the block and tackle can safely support may damage the tool or cause injury. Never overstress block and tackle sets.

Hook the fixed or stationary block to something solid and the moveable block to the load. Pull the free rope end to lift or move the load and tie it off to hold the load in place. Always stand clear of stressed lines and out of the load's path of movement. Never stand under a suspended load.



Regularly examine running gears and hooks for signs of fatigue. Inspect cables or ropes for fraying and replace when necessary. Periodically oil unsealed bearings. Be careful not to spill oil onto areas that might cause it to slip under stress.

Wheelbarrows

Wheelbarrows help carry rocks or dirt to or from the work-site. Most wheelbarrows have a metal box and frame, wood or aluminum handles, and solid rubber or pneumatic tires. We recommend pneumatic-tired wheelbarrows because tire inflation can be changed to roll easily on uneven terrain.

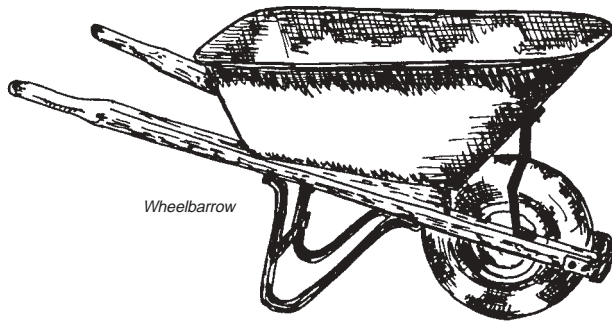

Select a wheelbarrow stout enough for the job. Typically, wheelbarrows hold 4 to 5 cubic feet and weigh 20 or more pounds. Lift a loaded wheelbarrow with your legs, not with your back. Keep your back straight, bend at the knees to get into a lifting position, and grasp the handles firmly.



Bending your knees and lifting with your legs avoids back strain or injury.

Balancing heavy loads on uneven terrain requires strong arms and legs. To avoid tipping, keep the load's center of gravity low to the ground. Good footing is essential. Learn and work within your physical limits. Several light loads will be easier and safer to manage than one large one. Prevent muscle strains by starting light and working up to heavy loads.

Although wheelbarrows usually require little maintenance, there are some things you can do. Lightly oil the wheel and axle occasionally, unless it has sealed bearings. Check handle bolts often for tightness and carry replacements in the field. Keep the box clean—dirt, water, or debris left standing in wheelbarrows will accelerate rusting. Turn the unit over at the end of the day's work, or if possible, store it out of the weather.

Cant Hooks and Peavies

Cant hooks and Peavies afford leverage for moving or rotating logs. The cant hook was originally used with a jam pike—a long pole with a spiked end. Loggers separated pieces with the hook after using the pike to pry them apart. Later these tools were combined by an American blacksmith, John Peavy, and the new tool bore his name. They weigh from 4 to 6 pounds and have handles from 2½ to 5 feet long. The size of log to be handled will dictate the size of the tool.

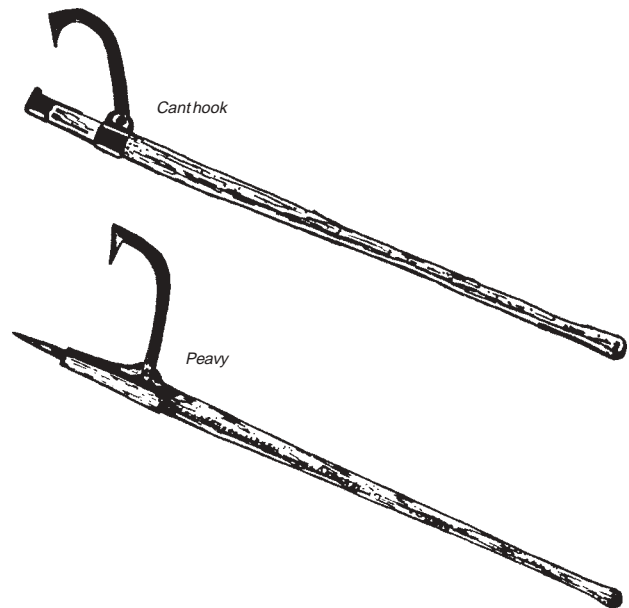

To roll a heavy log, use a series of short bites with the hook and maintain your progress by quickly resetting it. Catch the log with the hook hanging down so the point of the spike becomes the fulcrum on top of the log. Rotate the log using the leverage of the handle working the tool like a ratchet. Moving large logs may require several hooks working together. Avoid taking large bites; a heavy log will roll back and pin the handle before the hook can be reset.

Carry the Peavy by your side with the point forward. For balance, grip the handle behind where the hook attaches. Before walking, secure the hook against the handle to prevent injury to the operator or damage to the point of the hook. These tools also need maintenance. Keep hinged parts lightly oiled for proper movement. Spiked ends and hooks are usually bolted to handles, so check these frequently for tightness. Remove the spike ends and hooks when replacing handles. Carry replacements in the field. Sharpen hook ends with a mill bastard file and finish with a whetstone. Maintain factory bevels as much as possible.

Timber Carriers

Timber carriers enable teams of workers to move logs. With one tool the log is dragged. Several carriers could allow four or more persons to carry a large log. Hooks are 3 to 16 inches; handles are typically 4 feet long. Carriers weigh about 7 to 8 pounds.

Maintain the tongs on a timber carrier like cant hooks and Peavies. The tongs attach to the handle with a single bolt that is removed for handle replacement and carrying.

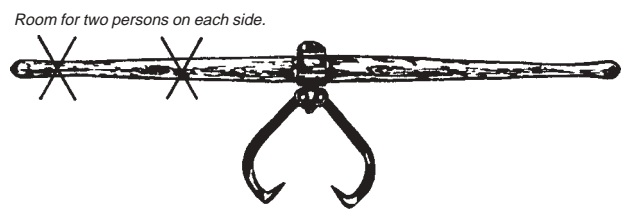

Timber carriers allow several persons to carry logs.

T ools for Peeling and Shaping

Bark Spuds (Peeling Spuds)

Use a bark spud to peel green logs. They have a 3 to 4-foot long handle and weigh about 4 pounds. Position the log about hip high. Hold the tool firmly with both hands and push the dished blade lengthwise along the log under the bark. Always pry away from your body. Three sharpened edges make this tool unusually hazardous to use and transport. Be mindful of the blade when working or walking near others.

Carry the spud at your side. Grip the handle near the middle and walk with the cutting edges away from your body and down. Maintain the original shape of the cutting blade when sharpening. Use a file and a whetstone on each edge on both sides.



A drawknife peels the bark off of logs.

Drawknives

Drawknives work best to peel dry logs. A standard drawknife has an 8- to 10-inch blade with perpendicular handles at each end and is 4 to 5 inches long.

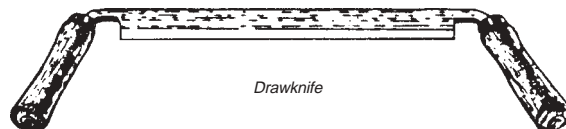

For greatest efficiency, position the log about waist high. When using the drawknife, grasp both handles so the beveled edge of the blade faces the log. Begin each stroke with arms extended and pull the tool toward you while keeping even pressure on the blade. Keep fingers clear of blade corners. Since the knife shaves to attain a flat surface, the largest strips will come from log edges.

You can change the thickness of shavings by rocking the blade back and forth on the edge bevel. Practice will yield proficiency.

Carry drawknives by one handle and at your side. Sharpen drawknives with a file or grinder. Maintain the edge bevel at 33°, and keep the blade cool to preserve the temper. Finish with a whetstone. Whet the blade by holding one handle with the blade facing up and securing the other. Hold the stone on the blade flat against the bevel and move it across the blade in a circular motion. When a wire edge forms on the full length of the blade, lightly whet the flat side to remove it.

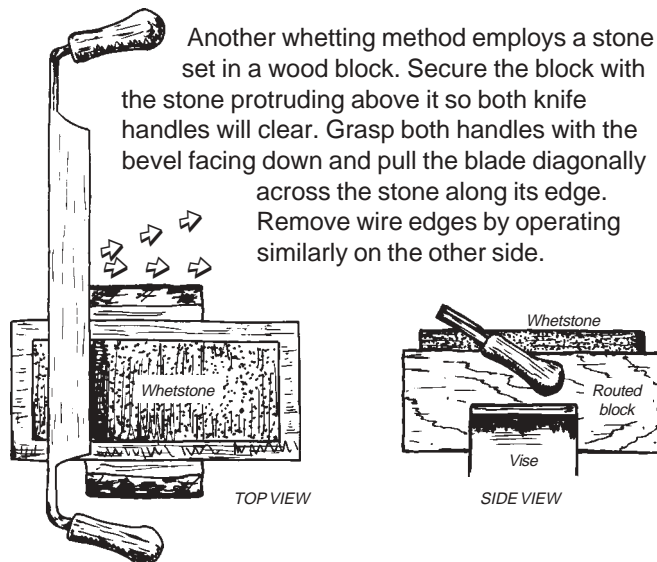

Sharpening a drawknife using a stone set in a wood block.

Carpenter's Adzes (Cutting Adzes)

This tool trims and shapes wood surfaces like hewed timbers or flattened logs. The cutting edge is 4 to 7 inches wide and 8 to 10 inches long. Adze heads weigh from 3 to 5 pounds with a cutting blade set perpendicular to the handle. The blade curves from the front of the head to the cutting edge, roughly matching the arc of the curved handle.

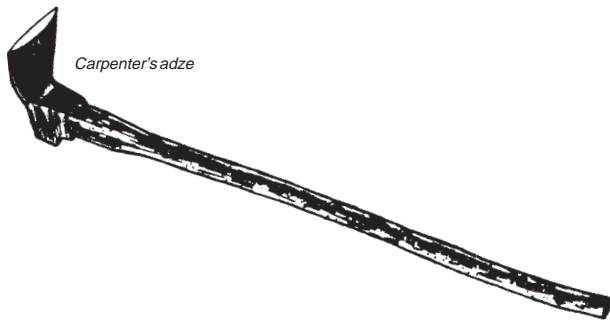

A square tapered eye and handle end allows the head to tighten when swung, but also allows its removal for carrying and sharpening. Some adzes may have a small set screw to further secure handles to heads. Keep the adze sharp. Maintain the cutting edge by regularly "touching it up" with a whetstone. If the blade needs reshaping, grind the edge bevel on the underside to 30°. Finish with a whetstone.

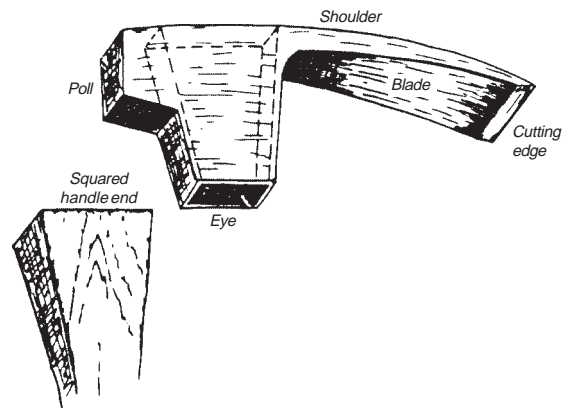

Detail of the carpenter's adze head.

To use a cutting adze, stand astride or on top of the log to be hewed. Grip the handle with both hands and swing it with short strokes in a pendulum motion along the log. Use your thigh as a stop for your arm and to control the depth of the cut. When standing on a log and swinging, take care to position yourself to miss your feet and legs.

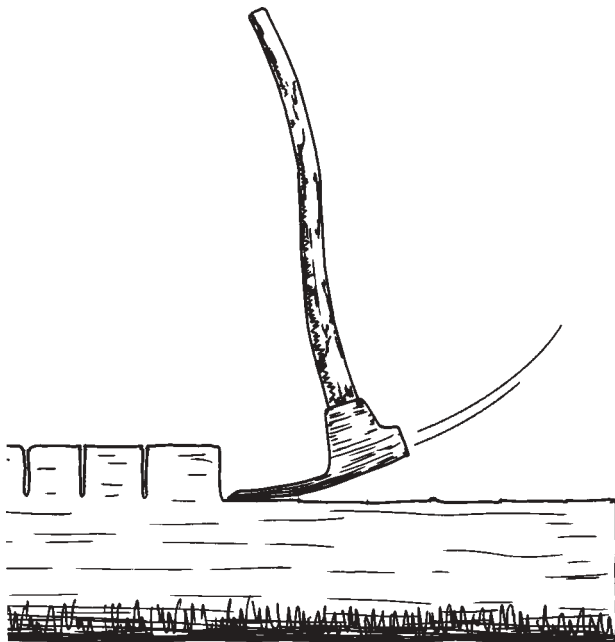

Hewing a log with a carpenter's adze.

Broadaxes

Use a broadax for hewing if no adze is available. Position the log so that scores are on one side and perpendicular to the ground. Depending on the size of the log, stand on the side opposite the scores or on top of the log. Large logs may require you to work on the same side as the scores.

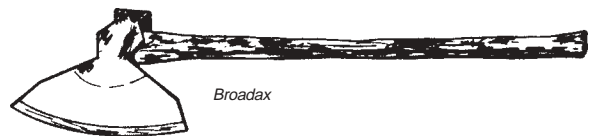

Additional safety hazards exist when hewing with a regular ax. Maintain control of the ax by grasping the handle near the middle with hands several inches apart. Use short swings to sever scored sections. Work the length of the log in one direction to remove most of the wood, then reverse directions for smoothing. Be extremely careful of glancing blows; work slowly and carefully. Frequent rest periods will help ensure efficiency and safety.

Hew logs in the following manner:

1—Elevate the log onto two short cross pieces and anchor it with log dogs. Log dogs are timber workers' clamps. One end is driven into the log and the other into a stable support. The log is held in place and both of the worker's hands are free for hewing.

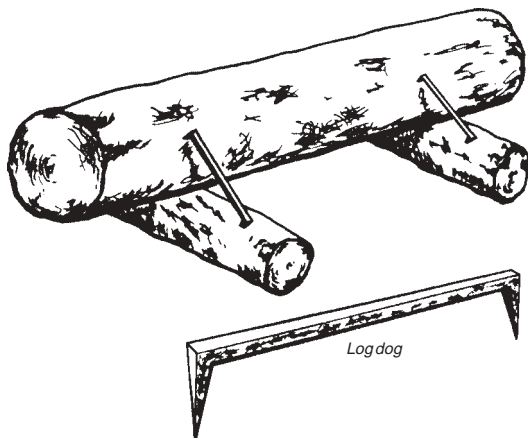

Log dogs steady the log while it is being hewn.

2—Mark a plumb line down the center of one end and a horizontal line perpendicular to it. Be sure to place the horizontal line deep enough to attain the desired width of finished flat surface.

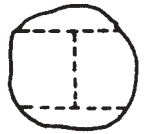

3—Repeat the procedure at the opposite end and snap two chalk lines connecting the horizontal end lines.

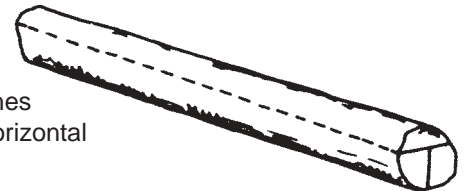

4—Using an ax or saw, score the log to the depth of the chalk lines, making the grooves parallel to the butt ends and as close together as necessary to hew a flat surface.

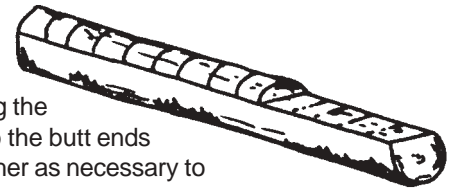

5—Hew (remove) the scored sections with an adze or broadax. If you use a broadax, hew the log face perpendicular to the ground rather than parallel, as shown here. The remaining sides may be marked, scored, and hewed as necessary.

Tools for Sharpening



Dull tools are useless and dangerous.

About Sharpening

A tool need not be old and worn to need sharpening. Many tools arrive dull from the factory. They may leave in good condition but become damaged during shipping. Inspect all tools before use. Sharpening makes tools last longer—a small scratch that is ignored could lead to a serious crack or nick in the blade.

Use a material like a file or grindstone that is harder than tool steel to remove metal from the edge. If there are no visible nicks, a touch-up with a whetstone will restore a keen cutting edge. In these instances, you need only restore the edge bevel. Whetting

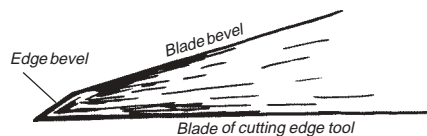

the edge removes very small bits of metal from the blade and causes the remaining metal to burr slightly on the cutting edge. This burr is called a feather, or wire edge. Remove this weak strip by honing the edge on the other side. The correctly honed edge is sharp, has no wire edge, and does not reflect light or show a sharpening line. Wear gloves when sharpening cutting edges.

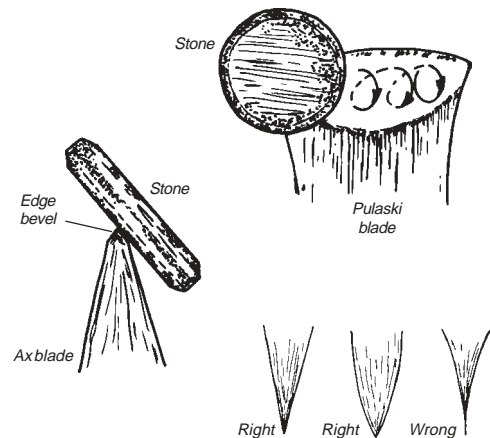

When sharpening an ax or Pulaski blade, for example, work the stone in small circles across and “into” the blade.

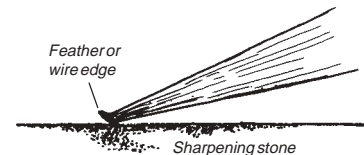

A wire edge is removed by honing the opposite edge.

Restoring the blade bevel requires coarser grinding tools to affect the shape of worn cutting blades. Reshape blades with hand files, sandstone wheels, or electric grinders. Remove visible nicks by grinding the metal back on the blade. Remember, however, that the correct blade bevel must be maintained. Remove the metal necessary to make the blade smooth while retaining its proper shape. If the shape is too radically affected, either have a blacksmith recondition the tool head or discard the tool.

The Missoula Technology and Development Center has developed a handtool sharpening gauge that provides a quick guide to the proper cutting angle for a number of tools. The gauge takes the guesswork out of sharpening Pulaskis (both ends), axes, shovels, combination tools, and McLeods. It has a “no-go” line that shows when a Pulaski

head is too worn to refurbish. The handtool sharpening gauge is available from the General Services Administration, item number: NSN 5210-01-324-2776, NFES 0510.

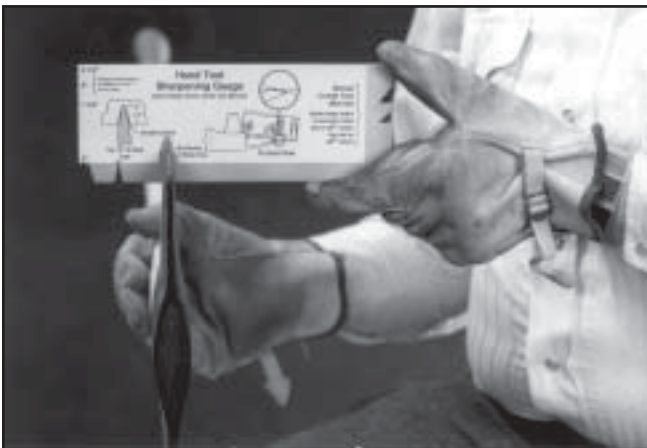
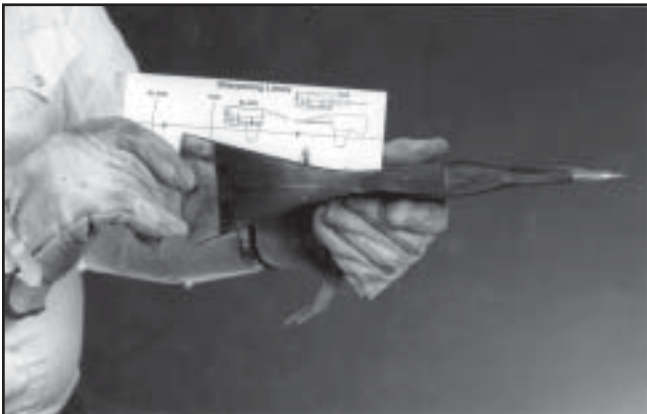

The handtool sharpening gauge is a handy aid for inspecting and sharpening a variety of fire handtools.

Files

Files come in single, double, curved, or rasp cuts. Single-cut files have one series of parallel teeth angled 60° to 80° from the edge, and are used for finishing work. Double cuts have two series of parallel teeth set 45° to each other; they are used for restoring shape. Curved and rasp cuts are used for shaping soft metals and wood, respectively.

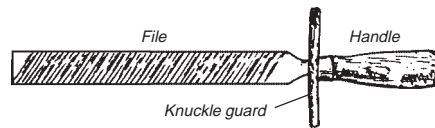

This file has a knuckle guard made from old linen hose.

Files vary in length and shape. Files are measured from the point to the heel, excluding the tang (the tip used to attach a handle). Length determines the coarseness of files. There are generally three degrees of file coarseness: *bastard*, *second cut*, and *smooth*. The bastard will be the coarsest file available, however only when it is included among different cuts of files of the same length. Of the many shapes of files currently on the market, you will probably not often use mill and flat files. Mill files are single-cut, and flat files are double-cut. A 10-inch mill bastard file is good for all-around tool sharpening.

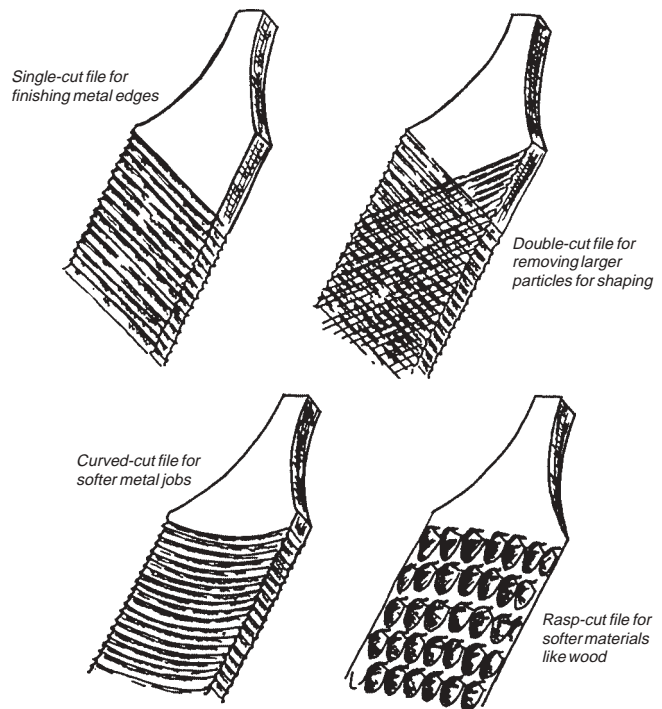

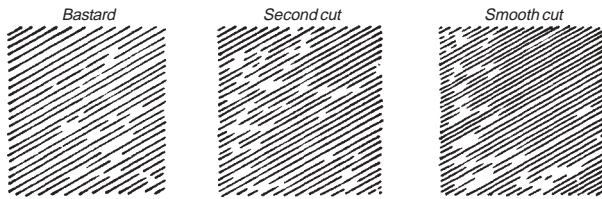

Comparative coarseness of files of uniform length.

Before filing, fit the file with a handle and knuckle guard. Always wear gloves on both hands to prevent cuts from the sharpened edge. Secure the tool so both hands are free for filing. Use the largest file you can, depending on the size, nature, and workable stroke length of the job. Remember that files are designed to cut in one direction only. Apply even pressure on the push stroke, then lift the file up and off the tool while returning for another pass. Store or transport files so they are not thrown together and protect them from other tools.

Maintain files with a brush or file card. A file brush has coarse and fine bristles and a wire pick for extracting trapped filings. A card has a small brush and a wire scorer.



Always wear gloves and goggles while filing.

Grinders

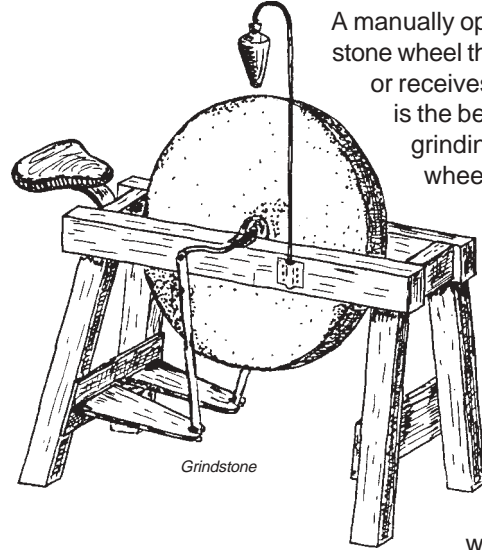

A manually operated sandstone wheel that runs through or receives dripping water is the best all-round grinding tool. The wheel turns slowly enough to allow monitoring of the amount of metal being removed and the water keeps the blade cool. For volume sharpening, a sandstone

wheel may be provided with mechanical power, but only if it remains geared to the same maximum rpm that a hand operation would allow.

Electric bench grinders quickly reshape damaged tools, but extreme caution must accompany their use. Improper electric grinding can ruin both the bevel and temper of a tool. High speeds remove metal from the blade quickly, which can cause it to weaken and chip easily. High speeds also allow heat buildup in tool heads, which can destroy temper and make it impossible for the blade to hold an edge. Using electric grinders, grind slowly and keep the blade cool. Inspect blades frequently to prevent too much metal from being ground from the blade. Dip the tool in water or cool it in open air. Avoid grinding on flat sides of electric wheels because they will weaken and break.

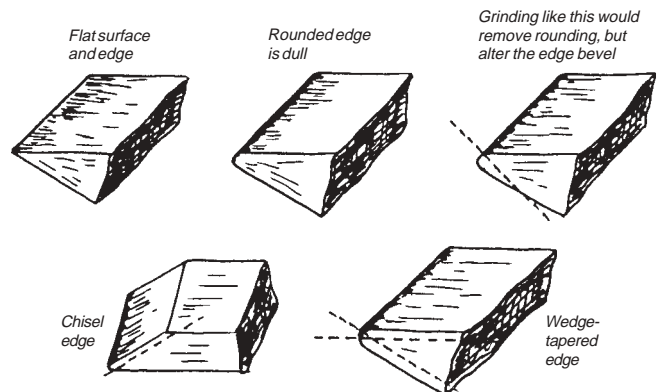

Grinding parallel to bevels maintains the correct angle.

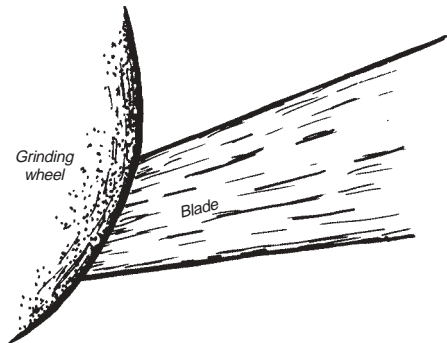

Sharpening a blade on a grinding wheel.

Finish the edge with a whetstone as if you were touching up. Blade and edge bevels may vary with individual preference and based on the task at hand. When sharpening an ax, for example, the blade bevel for use in softwoods might be thinner than one for hardwoods. Experience, observation, and experimentation will determine the appropriate bevels for each tool and cutting job.

Use adequate safety equipment when grinding tools. Always wear heavy leather gloves. Long-sleeved shirts and leather aprons will help prevent small burns from sparks or metal shavings. Proper eye protection is essential, including eye shields or safety goggles for operators and shields and hood guards on grinders. Hold portable grinders securely when using.

Whetstones

Use whetstones to finish sharpened cutting edges, or when touching up edges in the field. Whetstones are natural or manmade. We recommend synthetic abrasives for sharpening tools because they are harder than natural stones, the uniform honing particles assure an even sharpening surface, and they cost less than natural stones. If you prefer finishing with a natural stone, use a synthetic stone first. This produces a very sharp edge and saves expensive natural stones from unnecessary wear on rough work.

Most whetstone manufacturers soak new stones in light oil. You may also apply oil to the stone's surface before honing to float off pieces of metal and grit and prevent them from lodging in the stone's pores. If the stone glazes because the pores fill with shavings, clean it with citrus-based solvent and a stiff brush.

When whetting, use the entire stone surface to maintain its shape. Rotate the stone periodically to ensure even wear. If the surface becomes uneven, it may be reshaped by rubbing it over a sheet of glass sprinkled with carborundum powder or on a sheet of coarse sandpaper. Keep stone surfaces wet while reshaping them.

SHARPENING STONES						
Stone	Natural	Synthetic	Size (inches)	Cost (dollars)	Use	Sharpening Speed
Black hard Arkansas	X		8x2x1	50 to 60	Edge polishing	Very slow
Hard white Arkansas	X		8x2x1	30 to 40	Edge finishing	Slow
Soft Arkansas	X		8x2x1	15 to 20	Sharpening	Medium
Washita	X		8x2x1	25 to 30	Shaping-roughing	Fast
Silicon carbide		X	8x2x1	8 to 10	Roughing to sharpening	Fast to medium
India		X	8x2x1	8 to 10	Roughing to sharpening	Fast to medium
Crystolon		X	8x2x1	8 to 10	Roughing to sharpening	Fast to medium
Diamond-nickel		X	6x2x1 ¹ / ₁₆	25 to 30	Sharpening hard steels	Medium
Silicarbide-rubber		X	8x2x1	8 to 10	Deburring	Fast

T ools for Rehandling

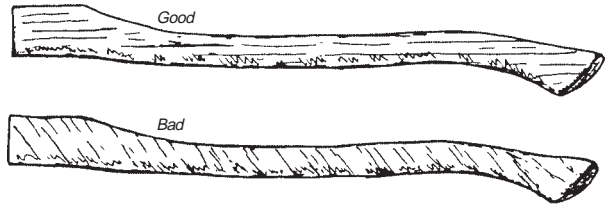

The grain of ax handles should run parallel to the wedge slot.



Diagram of the wedge slot and end grain of ax handles.

Fastening Wedges

The best wedges for securing tool heads are hardwood or plastic. Traditionalists swear that wooden wedges are best, but many new tools are equipped with plastic wedges. Avoid metal wedges for fastening heads to handles; these crush and weaken handle wood and make broken handles difficult to remove by drilling.

Sometimes a handle may need only a new wedge because the handle was not broken but loosened. In this case, carefully drill out the old wedge; remove the handle; clean the slot; and replace the handle on the head.

About Rehandling

Wood handles are common to most trail tools and are the most common type of replacement handle. Hickory makes the best handles for impact tools because it combines hardness and stiffness with excellent resiliency. For bent handles or simple handholds, ash is usually used.

When choosing tool handles, remember that straight grains offer maximum flexibility and strength. If possible, the grain should also be tight and knot-free, and it should run parallel to the wedge slot. Avoid coated handles. Painting or staining can hide flaws in materials or construction.

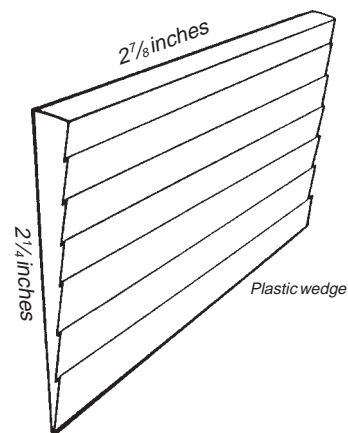

Plastic wedges used for securing tool heads. Wooden wedges are the choice of traditionalists.

Rehandling Procedures

Regularly inspect all tool handles and replace any cracked, rough, or badly weathered handles as soon as possible. When a tool needs a new handle, follow this step-by-step procedure. We have selected ax handles as the example for this discussion, but the technique is adaptable to other trail tools:

- ❑ Clear the eye of the tool. To remove worn or broken handles from the eye of a tool, place it upright in a vise and drill several holes into the wood from the top. These holes relieve pressure on the wood inside the eye so it can be driven out with a hammer and punch. If heads are epoxy-bonded to handles, soak the head in boiling water to soften the bond.
- ❑ Size up the tool and match an appropriate handle to the head. All handles will need some reshaping by hand to fit the head. Be sure that the top of the handle will fill the eye of the tool in both length and width.
- ❑ Saw the handle to an approximately correct length. If the handle was not factory sawed to accept a wedge, remove the head, secure the handle, and carefully saw down about two-thirds the depth of the head.
- ❑ Inscribe two perpendicular centering lines across the length and width of the handle end inside the eye. You will use them as a guide/check for centering the handle in the eye later. Make an additional mark below the head and just above where the handle broadens to denote the final seat for the head.
- ❑ Slowly remove excess material from the handle using a spoke shave, wood rasp, or grinder.
- ❑ Fit the eye of the tool to the handle. Light tapping on the tool head will allow repeated removal of the handle without damaging the wedge slot. Continue shaving and fitting until the head rests squarely $\frac{1}{4}$ to $\frac{3}{8}$ inch above the final seating mark. Make sure that the head is straight on the handle.
- ❑ With tool head aligned perpendicular with the handle, draw a line across both sides of the handle at the final seating mark. Saw a shallow cut along these lines to create a square shoulder. Fit the tool head to rest lightly on this shoulder.
- ❑ With rasp and sandpaper, uniformly backslope the handle from the perimeter of the handle to where the head finally seats. Carefully smoothing the handle just below the head prevents splintering.
- ❑ Use a long tapered wedge that extends the full width of the slot to attach the head to the handle. Drive the wedge into the slot, and tap alternately on the wedge and the end of the handle until the striking tool bounces off each with equal force. Use epoxy to fill remaining voids between the handle and the eye and seal out moisture.
- ❑ After the epoxy sets, trim excess wood flush with the top of the head. A hacksaw works best here because the blade will not be dulled by the metal, and because the saw blade can be turned 90° on the frame.
- ❑ Remove any varnish or paint from the handle. A light coating of raw linseed oil regularly applied will protect against drying and cracking. Some woods workers recommend drilling short holes in the base of the handle and periodically filling them with linseed oil. The oil penetrates the entire handle through natural pores in the wood.
- ❑ A loose handle can be temporarily tightened in the field by soaking the head in water or linseed oil. The wood in the head swells to accommodate the fluid and fits tighter in the eye. Make permanent repairs as soon as possible.
- ❑ Handles may also be shaved to fit individual grips more comfortably to reduce impact shock and hand and arm cramps. When shaving handles, proceed slowly and carefully; it is better to remove too little wood and have to trim again than to remove too much and have a weak or unusable handle.



A—Size up the tool head and match it to the handle. Note that the handle protrudes excessively long through the head. Scribe it to be cut off.



C—A line has been scribed below the roughly-fitted handle. The line denotes the final shoulder upon which the head sets.



B—Saw the handle to about the correct length. The handle has been roughly fitted so the head slides to within about $\frac{1}{2}$ inch of the final seating position.



D—The tool head has been snug-fitted to the square seating shoulder. Note that there is about $\frac{1}{2}$ inch excess handle above the head.



E—All surfaces just below the handle should be sanded smooth before the head is placed to insert the wedge. The wedge has been started in kerf.



F—The wedge has been driven home with the alternate driving of the wedge and the end of the tool handle.

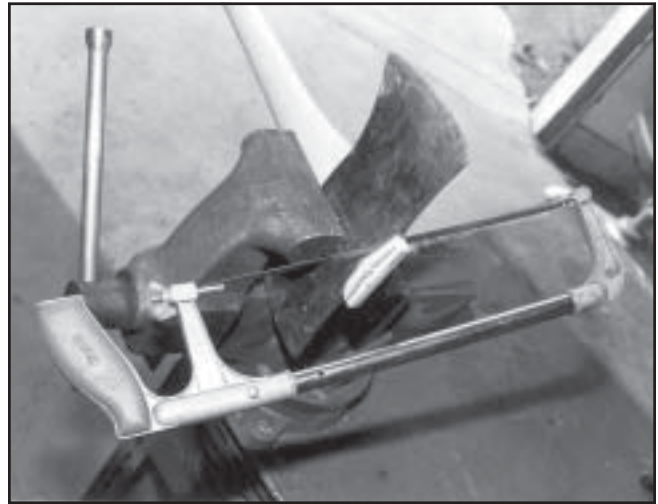

G—Use a hacksaw to trim off the excess handle and wedge flush with the tool head. Turn the saw blade 90° on the frame to facilitate the flush cut.



H—The finished mounted tool. The handle can be finish-sanded and oiled with raw linseed oil to protect against moisture.

Bibliography

The recreational trails publications produced by the Missoula and San Dimas Technology and Development Centers are available at the Recreational Trails Program Web site of the Federal Highway Administration U.S. Department of Transportation: <http://www.fhwa.dot.gov/environment/rectrails/publications.htm>

Printed copies can be ordered using the information on the front cover of this report.

Electronic versions of the trails publications plus a broader collection of recreation publications produced by the Missoula and San Dimas Technology and Development Centers are available at the Technology and Development Internet site (Username: t-d, Password: t-d): <http://www.fs.fed.us/t-d/search/>

Birchard, William, Jr.; Proudman, Robert D. 2000. Appalachian trail design, construction, and maintenance: 2nd ed. Harpers Ferry, WV: Appalachian Trail Conference. ISBN 1-917953-72-X. 237 p. (Copies for sale at 888-287-8673.)

Birkby, Robert C. 1996. Lightly on the land: the SCA manual of backcountry work skills, Student Conservation Association. The Mountaineers. ISBN 0-89886-491-7. 272 p. (Copies for sale at 603-543-1700.)

Demrow, Carl; Salisbury, David. 1998. The complete guide to trail building and maintenance. 3d ed. Boston, MA: Appalachian Mountain Club. ISBN 1-878239-54-6. 246 p. (Copies for sale at 800-262-4455.)

Didier, Steve; Herzberg, Diane. 1996. Stock-drawn equipment for trail work. Tech. Rep. 9623-2802-MTDC. Missoula, MT: U.S. Department of Agriculture, Forest Service, Missoula Technology and Development Center. 22 p. (Copies available at 406-329-3978.)

Gonzales, Ralph. 1996. Mechanized trail equipment. Tech. Rep. 9623-1207-SDTDC. San Dimas, CA: U.S. Department of Agriculture, Forest Service, San Dimas Technology and Development Center. 85 p. (Copies available at 909-599-1267, ext. 113.)

Griswold, Stephen S. 1996. A handbook on trail building and maintenance. 5th ed. Three Rivers, CA: U.S. Department of Interior, National Park Service. Sequoia Natural History Association. 136 p. (Copies for sale at 559-565-3758.)

Meyer, Kevin G. 2002. Managing degraded off-highway vehicle trails in wet, unstable, and sensitive environments. Tech. Rep. 0223-2821-MTDC. Missoula, MT: U.S. Department of Agriculture, Forest Service, Missoula Technology and Development Center. 48 p. (Copies available at 406-329-3978.)

Michael, David; Vachowski, Brian. 2004. Saws that sing: a guide to using crosscut saws. Tech. Rep. 0423-2822-MTDC. Missoula, MT: U.S. Department of Agriculture, Forest Service, Missoula Technology and Development Center. 64 p. (Copies available at 406-329-3978.)

Miller, Warren. 1977 (rev. 2003). Crosscut saw manual. Tech. Rep. 7771-2508-MTDC. Missoula, MT: U.S. Department of Agriculture, Forest Service, Missoula Technology and Development Center. 28 p. (Copies available at 406-329-3978.)

Monlux, Steve; Vachowski, Brian. 2000. Geosynthetics for trails in wet areas: 2000 edition. Tech. Rep. 0023-2838-MTDC. Missoula, MT: U.S. Department of Agriculture, Forest Service, Missoula Technology and Development Center. 18 p. (Copies available at 406-329-3978.)

Mrkich, Dale; Oltman, J. 1984. Hand drilling and breaking rock for wilderness trail maintenance. Tech. Rep. 8423-2602-MTDC. Missoula, MT: U.S. Department of Agriculture, Forest Service, Missoula Technology and Development Center. 26 p. (Copies available at 406-329-3978.)

Steinholtz, Robert T.; Vachowski, Brian. 2001. Wetland trail design and construction. Tech. Rep. 0123-2833-MTDC. Missoula, MT: U.S. Department of Agriculture, Forest Service, Missoula Technology and Development Center. 82 p. (Copies available at 406-329-3978.)

U.S. Department of Agriculture, Forest Service. 1999. Health and safety code handbook. FSH 6709.11. Washington, DC: U.S. Department of Agriculture, Forest Service. 503 p. (Reference copies available at Forest Service offices nationwide.)

U.S. Department of Agriculture, Forest Service. 1985. Trails management handbook. FSH 2309.18. Washington, DC: U.S. Department of Agriculture, Forest Service. (Reference copies available at Forest Service offices nationwide.)

- U.S. Department of Agriculture, Forest Service. 1992. Surface water control techniques for trail maintenance (video). 9923-2V01-MTDC. Missoula, MT: U.S. Department of Agriculture, Forest Service, Missoula Technology and Development Center. 27 minutes. (Copies available at 406-329-3978.)
- U.S. Department of Agriculture, Forest Service. 1994. Trails in wet areas—turnpike and puncheon construction (video). 9423-2V01-MTDC. Missoula, MT: U.S. Department of Agriculture, Forest Service, Missoula Technology and Development Center. 22 minutes. (Copies available at 406-329-3978.)
- U.S. Department of Agriculture, Forest Service. 1995. Basic trail maintenance (video). 9523-2V01-MTDC. Missoula, MT: U.S. Department of Agriculture, Forest Service, Missoula Technology and Development Center. 28 minutes. (Copies available at 406-329-3978.)
- U.S. Department of Agriculture, Forest Service. 1996. Standard specifications for construction and maintenance of trails. EM-7720-103. Washington, DC: U.S. Department of Agriculture, Forest Service. ISBN 0-16-048802-8. 108 p. Government Printing Office 001-001-00661-1 \$6.50.
- U.S. Department of Agriculture, Forest Service. 1997. Standard drawings for construction and maintenance of trails. EM-7720-104. Washington, DC: U.S. Department of Agriculture, Forest Service (Reference copies available at Forest Service offices nationwide.)
- U.S. Department of Agriculture, Forest Service. 1998. Handtools for trail work, part 1 and part 2 (videos). 9823-2V04-MTDC. Missoula, MT: U.S. Department of Agriculture, Forest Service, Missoula Technology and Development Center. 26 and 25 minutes. (Copies available at 406-329-3978.)
- U.S. Department of Agriculture, Forest Service. 1998. Standards for Forest Service signs and posters. EM-7100-15. Washington, DC: U.S. Department of Agriculture, Forest Service. (Reference copies available at Forest Service offices nationwide.)
- U.S. Department of Agriculture, Forest Service. 1999. An ax to grind, part 1 and part 2 (videos). 9923-2V01-MTDC. Missoula, MT: U.S. Department of Agriculture, Forest Service, Missoula Technology and Development Center. 30 minutes each part. (Copies available at 406-329-3978.)
- U.S. Department of Agriculture, Forest Service. 2000. Constructing trail switchbacks (video). 0023-2V02-MTDC. Missoula, MT: U.S. Department of Agriculture, Forest Service, Missoula Technology and Development Center. 28 minutes. (Copies available at 406-329-3978.)
- Vachowski, Brian; Maier, Neal. 1998. Off-highway vehicle trail and road grading equipment. Tech. Rep. 9823-2837-MTDC. Missoula, MT: U.S. Department of Agriculture, Forest Service, Missoula Technology and Development Center. 20 p. (Copies available at 406-329-3978.)
- Volunteers for Outdoor Colorado. 1992. Crew leader manual. Denver, CO: Volunteers for Outdoor Colorado. 109 p. (Copies for sale at 303-715-1010, ext. 20.)
- Weisgerber, Bernie; Vachowski, Brian. 1999. An ax to grind: a practical ax manual. Tech. Rep. 9923-2823P-MTDC. Missoula, MT: U.S. Department of Agriculture, Forest Service, Missoula Technology and Development Center. 60 p. (Copies available at 406-329-3978.)
- Wernex, Joe. 1994. Off highway motorcycle & ATV trails guidelines for design, construction, maintenance and user satisfaction. 2nd ed. Pickerington, OH: American Motorcyclist Association. 56 p. (Copies for sale at 614-856-1900.)
-

A Appendix—American Pattern Files

MILL FILES

The following illustrations show the actual coarseness of Mill files.

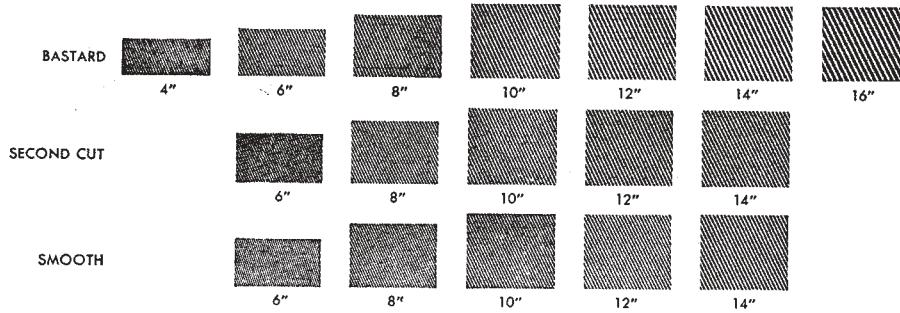

FLAT FILES

The following illustrations show the actual coarseness of Flat files.

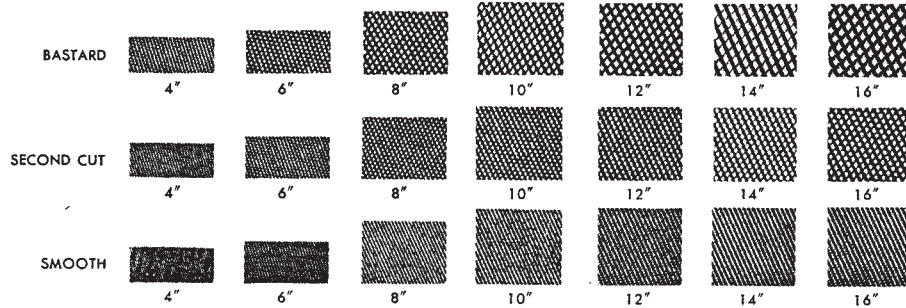

HALF ROUND FILES

The following illustrations show the actual coarseness of Half Round files.

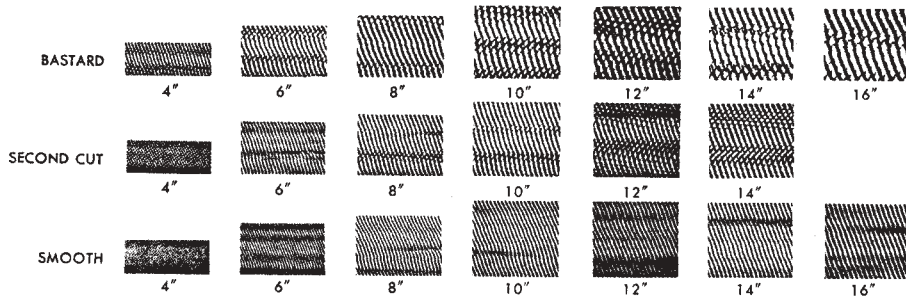

ROUND FILES

The following illustrations show the actual coarseness of Round files.

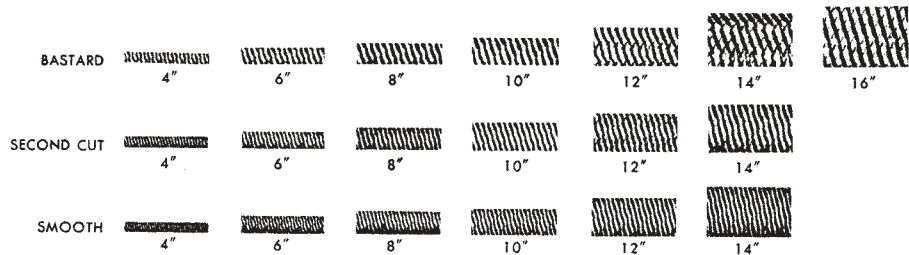

A dze hoe	19	Folding pruning saw	9	Pruning saw	9
Anvil lopping shears	23	Fulcrum	21,33,35	Prying bars	22,33
Arc-ground saw	6	G loves	3,8,14,27,31,44	Pulaski	17,42
Asymmetric crosscut saw	5	Goggles	17,18,44	R aker teeth	7
Axes	13,14,25,39	Grass hook	28	Rasp	46
B ank blades	24	Grass nail	27	Rasp cut	42
Bark spuds	37	Grass whip	28	Rehandling	45
Bars	22,33	Grinders	18,41,43	Round file	51
Bastard cut file	42	Grinding wheel	43	S afety	3,5,13,17,18,21,24,26,31,44
Bastard file	23,25,26,43,51	Grindstone	41	Sandstone wheel	41,43
Bench grinder	43	Grub hoe	17,19	Sandvik ax	25
Bevel angle	43	Grubbing tools	17-19	Saw	5
Bevel edge	29,41,44	H ammers	29,31	Scythe	27
Blade bevel	41	Hammering tools	29	Segment-ground saw	6
Block and tackles	33	Hand chain saw	7	Shaping tools	41-44
Bow saw	7,8	Hand drilling hammer	29	Sharpening	8,10,14,17-19,21,22,26,27,37,41,43
Broadaxes	13,38,39	Handles	9,13,19,30,45	Sharpening stone	44
Brush axes	25	Hand pruner	33	Sharpening tools	41,44
Brush cutters	24	Hatchet	14	Shears	23
Brushing tools	23-38	Hauling tools	33,35	Sheaths	3,5
Bucking crosscut saw	5	Hazel hoe	19	Shovels	21
Bush hook	24	Hewing	38	Sickle	28
C ant hook	34	Hoes	17-19	Single-bit ax	13
Carpenter's adze	38,39	Hook-type lopping shears	23	Single jacking	29
Clamp-type bow saw	7	J amp pike	34	Sledge hammer	29
Chisel tip	18	K erf	7	Snath	27
Clearing knife	25	Kinking	7	Stone sledge	29
Combi tool	17,18	Knuckle guard	42,43	Storing saws	6
Combination tool	17,18	L evers	12,21,31,33	Swan neck hoe	20
Corn knife	27	Lifting tools	33,35	Swedish brush ax	25
Council bank blade	25	Limbing	8-10	Symmetric crosscut	5
Crescent-ground saw	6	Log dogs	39	T ackle	33
Crosscut saw	7	Lopping shears	23	Tamping bar	22
Crosscut sheath	6	Lubricating	7,8,44	Tamping tools	22
Crowbar	33	M achete	26	Taper-ground crosscut saw	5
Cutter mattock	19	Mattocks	19	Telescoping tree pruner	11
Cutting adze	38,39	Mauls	29	Timber carrier	35
D igging bar	22	McLeod	18	Tobacco knife	27
Digging tools	21	Mill file	42,51	Tongs	35
Double-bit ax	13	N ailing hammer	31	Transporting tools	3,6,9,14,17,21-23,27,35,37
Double-edge pruners	9	Nib	27	Tree pruner	10
Double jacking	29,31	Notching	7,14	Tree trimmer	14
Draw hoe	20	P eavy	34	U nderbucking	7
Drawknife	37	Peeling spud	37	Undercutting	7
Driving sledge	29	Peeling tools	37-39	Utility saw	10
E lectric bench grinder	43	Pick	18,21	W edges	7,12,45
Engineer's hammer	30	Pick mattock	19	Weed cutter	26-28
Entrenching tool	17	Plumb-hammer hatchet	15	Weed hook	28
F astening wedges	45	Pole pruner	10,11	Weed knife	26,28
Feathers	29	Pole saw	10	Wheelbarrow	34
Felling crosscut saw	5	Pounding tools	29-31	Whetstone	18,23,26,28,35,37,44
File brush	43	Pruners	9,23	Woodsmen's Pal	26
Files	14,18,21,23,25,41,42				
Fire hose saw sheath	6				
Flat-ground crosscut saw	5				

Notes

Library Card

Hallman, Richard G. (retired). 2005. *Handtools for trail work*: 2005 edition. Tech. Rep. 0523–2810–MTDC. Missoula, MT: U.S. Department of Agriculture, Forest Service, Missoula Technology and Development Center. 54 p.

Describes the handtools commonly used by Forest Service trail crews for sawing, chopping, grubbing, digging and tamping, brushing, pounding and hammering, lifting and hauling, peeling and shaping, sharpening, and rehandling. Includes many illustrations of the tools. Updates *Handtools*

for Trail Work, originally published in 1988 (8823–2601–MTDC). The updates include a new, more comprehensive bibliography of trail construction and maintenance references and updated information about a few pieces of equipment that appeared promising in 1988, but were not widely adopted.

Keywords: axes, bibliographies, hammers, hand tools, saws, sharpening, tools

Electronic copies of MTDC's documents are available on the Internet at:

<http://www.fs.fed.us/t-d> (Username: t-d, Password: t-d)

For further technical information, contact Gary Hoshide at MTDC.

Phone: (406) 329–1029

Fax: (406) 329–3719

E-mail: ghoshide@fs.fed.us

Forest Service and Bureau of Land Management employees can search a more complete collection of MTDC's documents, videos, and CDs on their internal computer network at:

<http://fsweb.mtdc.wo.fs.fed.us/search>