

SIMONDS

SAWS
KNIVES
FILES
STEEL

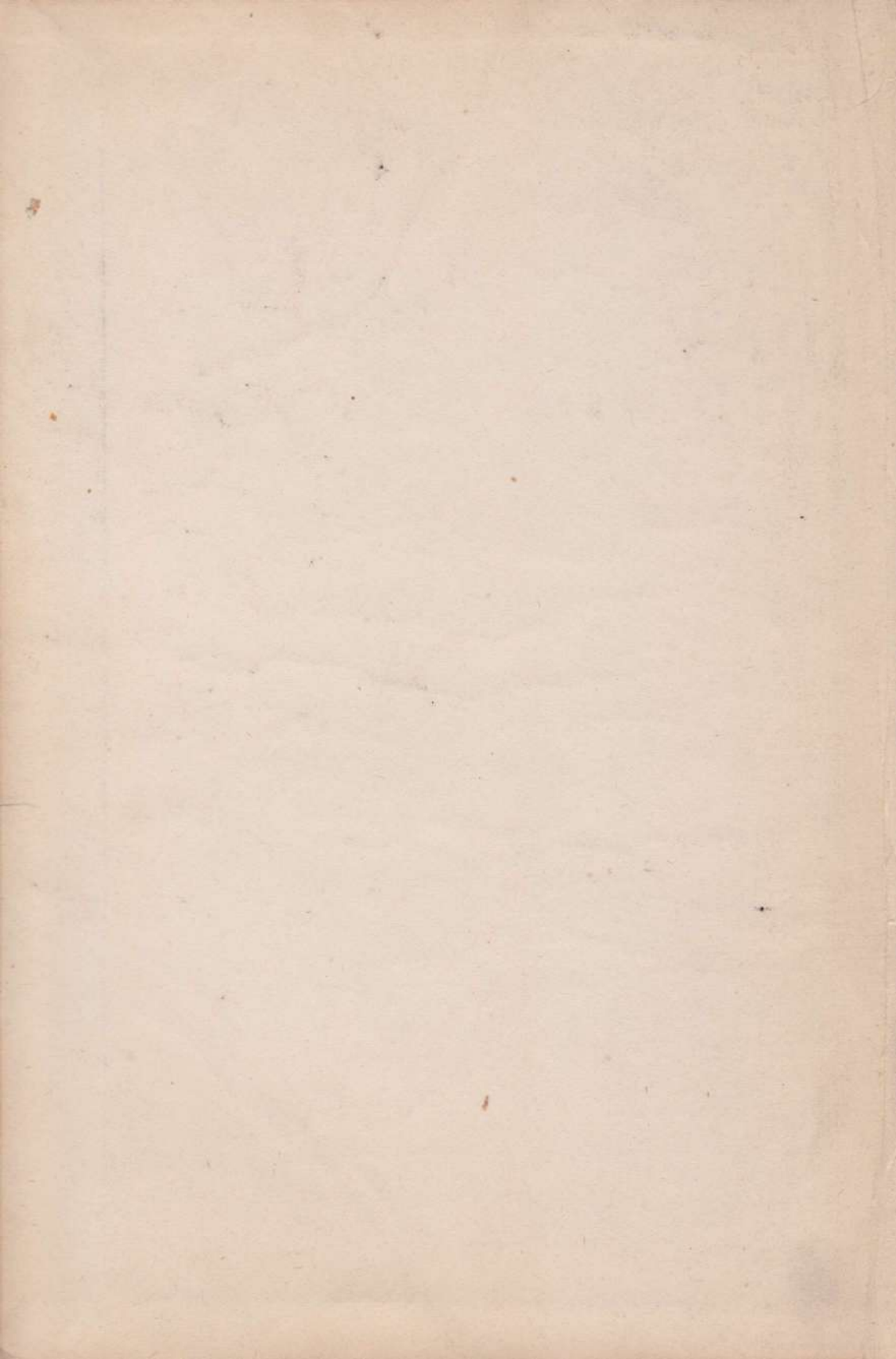

C. I. S. 1925



170 JM
Service Station

127-129 S. Green St

Chicago, Ill.

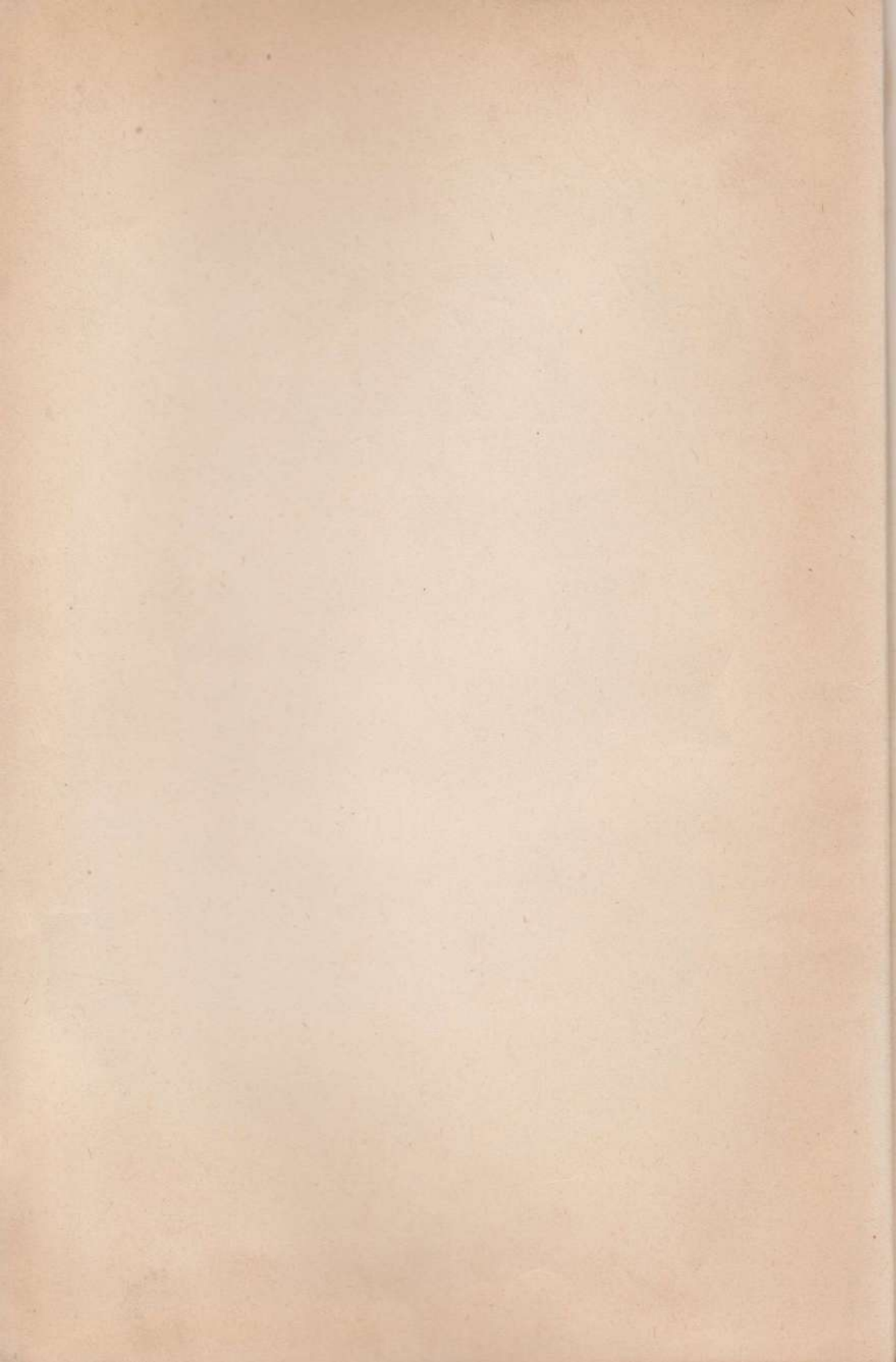



The Four Factories and Steel Mill of the
Simonds Manufacturing Company



WARRANTY
The Simonds Saw & Steel Works
PITTSBURGH, PA. U.S.A.
MADE IN U.S.A.
TRADE MARK

SIMONDS

66 THE SAW MAKERS 99

Catalogue No. 23



SIMONDS MANUFACTURING CO.

Saws, Knives, Files and Steel

The only American Saw or Knife Manufacturer to have received the Grand Prix at any exposition ever held in Paris

Simonds Saw and Steel Company

Successor to

Simonds Manufacturing Co.

Executive Offices and Works..... FITCHBURG, MASS.
Western Avenue and 16th and 17th Streets..... CHICAGO, ILL.
Mt. Elliot and East Fort Street..... DETROIT, MICH.
239 Court Avenue..... MEMPHIS, TENN.
420 Canal Street (Simonds Mfg. Co., Ltd.)..... NEW ORLEANS, LA.
85-87-89 First Street..... PORTLAND, ORE.
410 Occidental Avenue..... SEATTLE, WASH.
14 Natoma Street, near First Street..... SAN FRANCISCO, CAL.
53A Bayham Street, Camden Town..... LONDON, N. W., ENG.
Steel Mill..... LOCKPORT, N. Y.
Export Department, 90 WEST BROADWAY, COR. CHAMBERS STREET,
NEW YORK CITY

Simonds Canada Saw Co., Limited

St. Remi Street and Acorn Avenue..... MONTREAL, P. Q.
554 Beatty Street..... VANCOUVER, B. C.
55 Water Street..... ST. JOHN, N. B.

Simonds File Co.

FITCHBURG, MASS.

Cable Addresses

SIMONDS, Fitchburg. SIMANCO, N. Y. City.
SIMANCO, Chicago.

Codes: Simonds; A B C, 4th & 5th Editions;
Lieber's; Western Union; Postal.

Established in 1832

Orders sent to any of our above houses will receive prompt and careful attention. On application we will furnish order blanks for Saws or Knives of all kinds.

Simonds Trade Marks



Used on all Simonds Saws made in the U. S. A.



Used on Simonds Knives



Used on all Saws made by us in Canada



Used as a side etch on Simonds Hand Saws

SIMONDS H. E.

Stamped on Simonds Hard Edge Non-breaking Hand Hack Saw Blades

Simonds

Stamped on Simonds Files

Warranty. Each "Simonds" Saw is warranted as true as it is possible to make it; free from flaws and seams. If found to be defective in any of these particulars, it may be returned to us, and if on examination the saw is found to be at fault, all necessary repairs will be made free of charge, or a new saw given in exchange, provided it is returned within 30 days from delivery. The gumming of Saws with punches or dies that are not in proper condition; the filing of square corners in the gullets of teeth; or the case hardening of the gullets by improper use of emery wheels, are almost certain to cause cracks in the plate. Our warranty does not cover such cases.

Our Terms to all parties who are satisfactorily rated in Dun or Bradstreet, or who will furnish us with suitable bank or commercial references, are thirty days. In other cases we will follow our usual custom and send goods C. O. D.

All Quotations are made and goods invoiced at current prices, these prices being *subject to change without notice*. We reserve the right to correct stenographic errors in quotations or invoices, and we will not hold ourselves responsible for delays due to causes beyond our control.

All Orders, either by mail or through our agents, are subject to our approval, and if declined, parties will be notified immediately.

Shipping Directions. Give explicit instruction for routing each shipment, and thus avoid unnecessary delays in delivery.

Shipments are invariably made at purchaser's risk, and all prices are f. o. b. factory.

Packages by Mail. Packages may be forwarded by mail in conformity with postal regulations. In the United States, 70 pounds may be mailed to points in the first and second postal zones; 50 pounds may be mailed any distance.

Errors or Shortages should be reported promptly on receipt of goods.

Overdue Accounts subject to sight draft.

Remittances should be made in funds current at par in New York City, Boston, or Chicago.



Simonds Saw Steel

Steel science is a matter of knowledge.

The science of steel-making is the knowledge of how steel should be made to secure definite desired qualities in the finished product into which the steel is ultimately made.

Primarily, we are steel scientists.

Secondly, we are steel artisans, because we use our knowledge of steel-making to produce in our own steel mills steel that can be used most effectively in the important industries of the world in the many ways those industries demand.

Simonds Steel is made in both electric furnaces and crucible furnaces. These two methods, of which the electric furnace is the most modern, are the only known methods of producing high-quality steel in commercial quantities.

Simonds Steel is made to any required analysis or mix. It is made

SIMONDS—"THE SAW MAKERS"

in bars or in flat plates, which plates we harden, temper, grind, and form to practically any specified shape.

Saws, the chief product of the Simonds manufacturing plants, are made of Simonds Steel plates. It is therefore possible for the Simonds Company, making its own saw steel, to so exercise the science of steel-making as to insure the proper analysis of the steel that goes into Simonds Saws.

The very necessity for absolutely controlling the making of our Saw Steel was, in fact, the reason why we built our first steel mill in Chicago twenty-two years ago. Previous to that time we bought our steel from the best-known makers in the United States and England; but knowing that our reputation for high-grade saws depended largely on a uniformly high grade of steel, building a mill of our own was imperative. Safety is such an important item about a saw in operation that a vital feature of the steel plate must be its tenacity. The ability to wear well is the measure of a saw's efficiency.

In 1911 our Chicago Steel Department was moved to Lockport, N. Y., where we then built the most modern, high-grade steel mills in existence. They are entirely electrically operated by current direct from Niagara Falls, only twenty-five miles away.

Sawmill men and other users of high-grade steel products should make an opportunity to some day accept our invitation to visit these Steel

Mills, see Simonds Saw Steel made, and acquaint themselves with the wonderful progress that has been worked out in this marvelous institution devoted exclusively to the science of making steel.

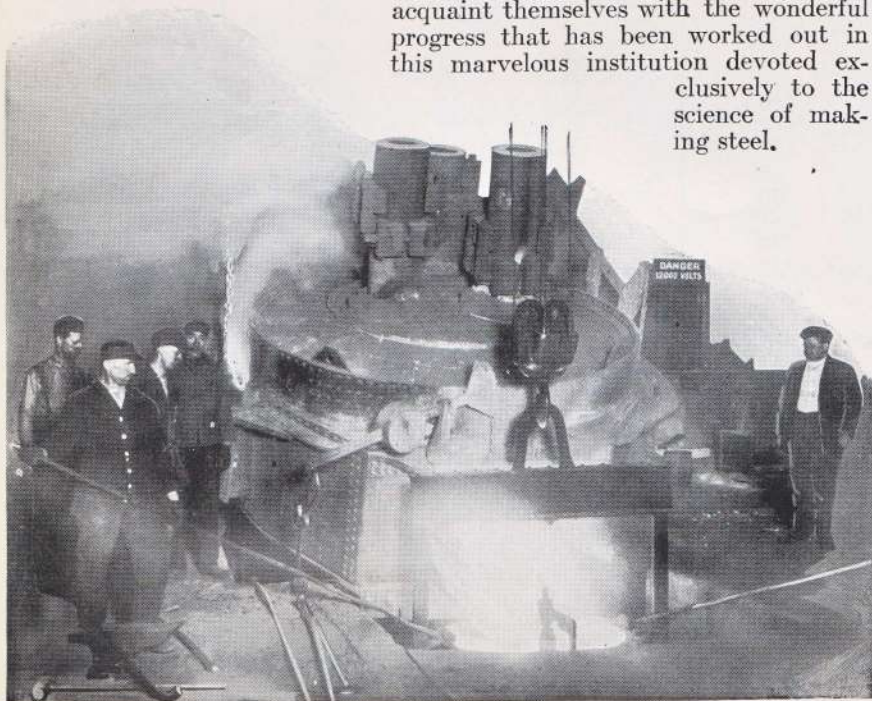

Saw Gauges

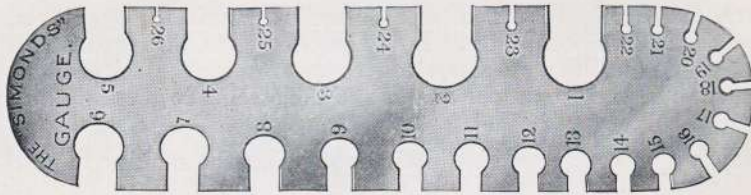

Our Standard Gauge

Gauge	Fraction Inch	Thousandths Inch	Millimeters
	1	1.000	25.40
	$\frac{7}{8}$.875	22.225
	$\frac{3}{4}$.750	19.05
	$\frac{5}{8}$.625	15.875
	$\frac{1}{2}$.500	12.70
	$\frac{15}{32}$.46875	11.905
0000	$\frac{23}{64}$.454	11.53
000	$\frac{21}{64}$ Full	.425	10.79
00	$\frac{3}{8}$ Full	.380	9.65
0	$\frac{11}{32}$ Scant	.340	8.64
1	$\frac{5}{16}$ Scant	.300	7.62
2	$\frac{9}{32}$.284	7.21
3	$\frac{1}{4}$ Full	.259	6.57
4	$\frac{15}{64}$.238	6.04
5	$\frac{7}{32}$.220	5.59
6	$\frac{13}{64}$.203	5.18
7	$\frac{9}{16}$ Scant	.180	4.57
8	$\frac{5}{16}$ Full	.165	4.19
9	$\frac{5}{32}$ Scant	.148	3.76
10	$\frac{1}{8}$ Full	.134	3.40
11	$\frac{7}{8}$ Scant	.120	3.05
12	$\frac{7}{64}$.109	2.77
13	$\frac{3}{32}$.095	2.41
14	$\frac{5}{64}$ Full	.083	2.10
15	$\frac{5}{64}$ Scant	.072	1.82
16	$\frac{1}{16}$ Full	.065	1.65
17	$\frac{1}{16}$ Scant	.058	1.47
18	$\frac{3}{64}$.049	1.24
19042	1.06
20035	.89
21	$\frac{1}{32}$.032	.81
22028	.71
23025	.64
24022	.56
25020	.51
26018	.46
27	$\frac{1}{64}$.016	.41
28014	.36
29013	.33
30012	.30

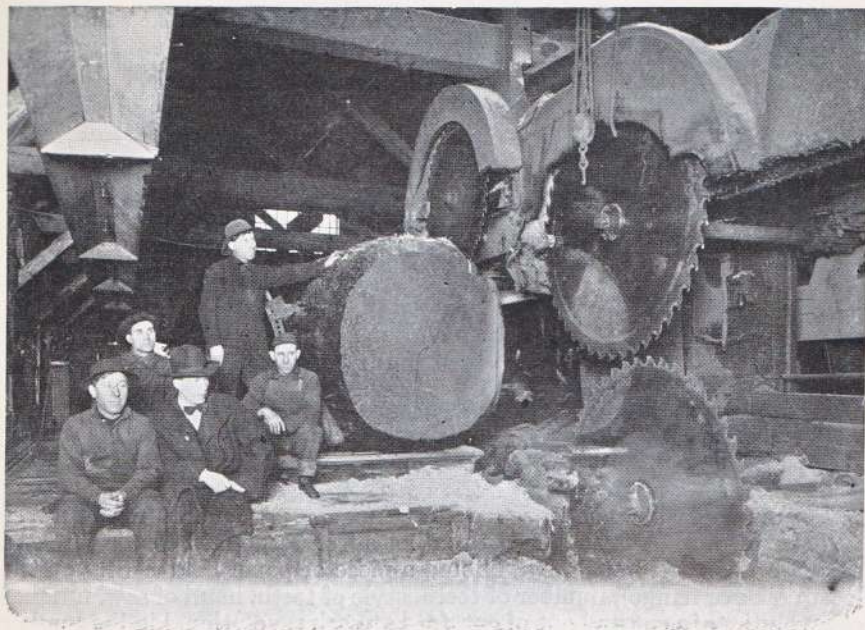

Simonds Inserted Point Saw

The Simonds Saw is capable of standing heavy feed.

It will run for years. It always remains the same size.

New Points can easily be inserted at any time by any one, and the result is a sharp saw just as good as new.

To have an Inserted Point Saw do good cutting for many years get a Simonds, because the slots or grooves in the teeth and the "V" on the plate are *machine-milled*, making a perfect-fitting joint.

Points are tempered much harder than saw plates. Points not machine-milled are very liable to cut the plate, and soon they will not fit properly. Therefore to insure the life of your saw see that it is a Simonds and that only genuine Simonds machine-milled points and shanks are used on it.

The shank is the holder which locks the point in place on the saw plate and is made on a different circle from that of the Point — a decided advantage.

Simonds Saws have good open gullets, allowing plenty of room for sawdust, and the teeth are scientifically made, to allow greatest clearance.

The Point in the Simonds Saw is set so that the body of the plate is

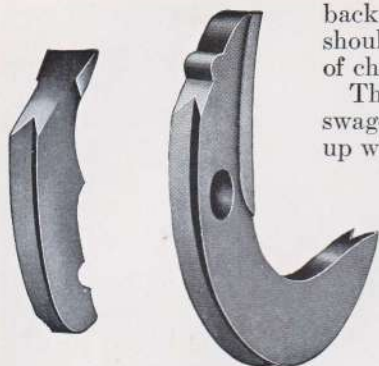

back of it, a method far superior to the small shoulder which holds the Point in other makes of changeable-tooth saws.

The Simonds Point can, when necessary, be swaged lightly in the plate or it can be touched up with a file.

Because of its many individual advantages, you will find the Simonds Saw easily the best wearing and most satisfactory Inserted Point Saw to be had anywhere.

Saws are hammered to suit the speed maintained in customer's mill and made for either right-hand or left-hand mill.

When buying a new mill, specify that a Simonds Saw be furnished with it, or get the mill without a saw and buy your saw direct from our factory.

The following information should be given on an order for a new saw: size or diameter, gauge at eye, gauge at rim, size of mandrel hole, number and size of pin holes, distance of pin holes from center to center (or send a template of holes made by rubbing a piece of paper held tightly on the loose collar or flange), number of teeth, style of teeth, hand of saw, number of revolutions in cut and out of cut, feed at each revolution, kind of lumber sawed, daily capacity, horsepower available, and say whether the mandrel runs cold, warm, or hot. State when the saw is wanted, and whether it should be shipped freight or express.

If you are in doubt about any of the above specifications, write us giving full particulars, regarding your mill, and we will gladly recommend the proper size saw, etc., which our many years' saw-making experience has found advisable for use on a mill like yours. Write for discounts from list prices.

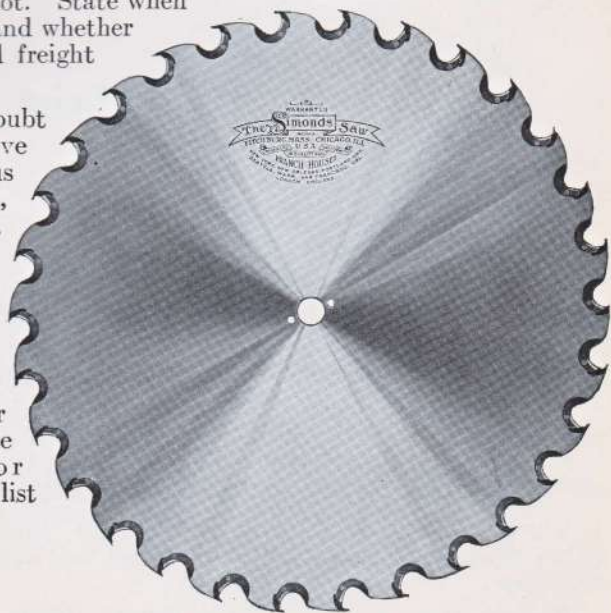

On the following pages will be found sectional cuts of this saw, with the Points and Shanks engraved to show their actual sizes.

Simonds Inserted Point Saws

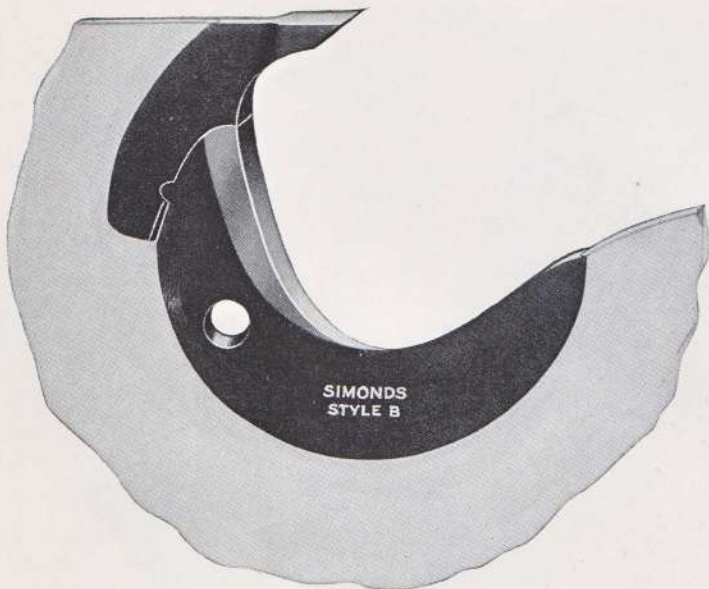

Style B, for Medium Tooth Saws (Full Size)

The number of teeth for B Saws shown on page 15.

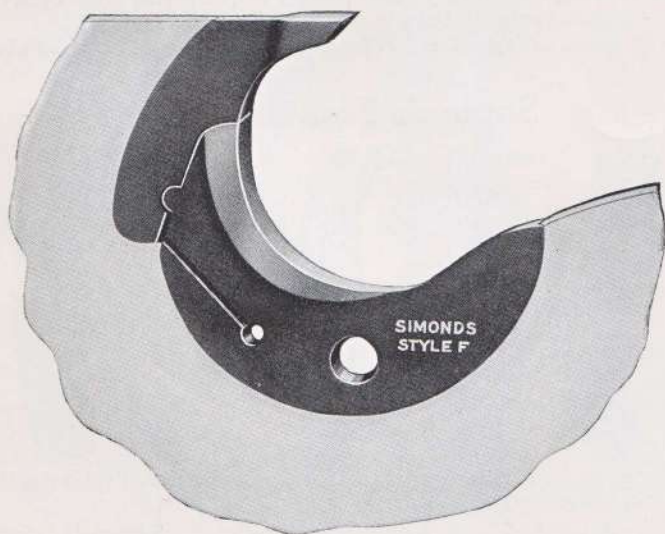

Style F, for Fine Tooth Saws (Full Size)

In our Style F Saw we can insert as many teeth as the diameter of the saw less two; for instance, in a 50 inch saw 48 teeth, in a 66 inch saw 64 teeth.

Simonds Inserted Point Saws

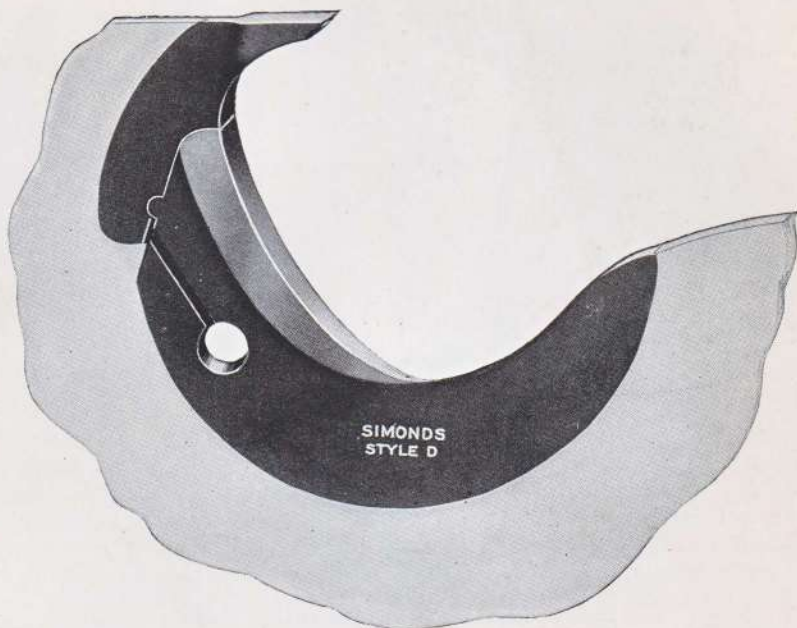

Style D, for Coarse Tooth Saws (Full Size)

Our Style D Saw is adapted to the requirements of the Pacific Coast mills. Forty-six teeth is the maximum number that can be put in a 60 inch saw.

On page 13 are shown Styles B and F, for saws requiring a greater number of teeth.

Simonds Points or Bits

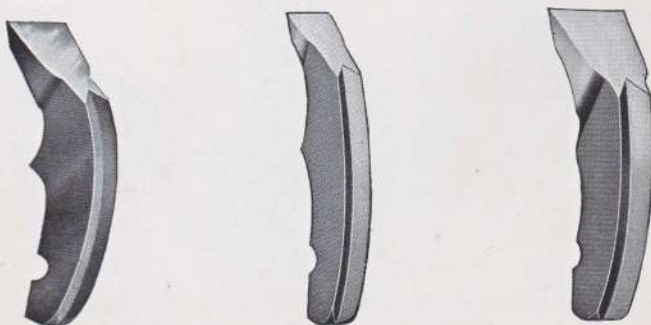

The following is a list of Points carried in stock showing gauge, and width of kerf or cutting edge. When ordering always specify *kerf* and *gauge*.

11 gauge $\frac{7}{32}$ inch kerf

10 " $\frac{1}{4}$ " "

9 " $\frac{9}{32}$ " "

8 gauge $\frac{13}{32}$ inch kerf

8 " $\frac{5}{16}$ " "

7 " $\frac{3}{8}$ " "

7 gauge $\frac{11}{32}$ inch kerf

6 " $\frac{13}{32}$ " "

6 " $\frac{3}{8}$ " "

Packed 100, 250, or 500 Points to a box.

Write for Discounts

Simonds Inserted Point Saws

Styles B, F, and D

Diameter	Thickness	Standard Number of Teeth		Greatest Number of Teeth that can be put in Saw			Price	Extra for each Gauge Heavier	Price for Beveling New Saws per Gauge
		B & D	F	B	F	D			
12 inch	11 gauge	8	10	8	10	..	\$32.00	\$0.30	\$0.55
14 "	10 "	10	12	10	12	..	37.00	.40	.65
16 "	10 "	12	14	12	14	..	39.00	.50	.75
18 "	10 "	14	16	14	16	..	44.00	.60	.90
20 "	9 "	14	18	16	18	..	50.00	.75	1.05
22 "	9 "	16	20	18	20	..	56.00	.90	1.20
24 "	9 "	18	22	20	22	..	62.00	1.05	1.35
26 "	9 "	18	24	22	24	..	68.00	1.25	1.55
28 "	9 "	20	26	24	26	..	74.00	1.50	1.75
30 "	9 "	20	28	26	28	22	80.00	1.75	1.95
32 "	8 "	22	30	28	30	24	88.00	2.00	2.15
34 "	8 "	22	32	30	32	24	97.00	2.25	2.35
36 "	8 "	24	34	30	34	26	106.00	2.60	2.55
38 "	8 "	24	36	32	36	28	115.00	3.00	2.75
40 "	8 "	26	38	34	38	30	125.00	3.40	2.95
42 "	8 "	28	40	36	40	32	137.00	3.80	3.25
44 "	8 "	30	42	38	42	32	150.00	4.40	3.55
46 "	8 "	30	44	40	44	34	165.00	5.15	3.85
48 "	8 "	32	46	42	46	36	180.00	5.90	4.15
50 "	8 "	34	48	44	48	38	200.00	6.65	4.45
52 "	7 "	36	50	46	50	38	220.00	7.40	4.80
54 "	7 "	38	52	48	52	40	250.00	8.80	5.15
56 "	7 "	40	54	50	54	42	280.00	10.25	5.50
58 "	7 "	42	56	50	56	44	310.00	11.75	5.95
60 "	7 "	42	58	52	58	46	340.00	13.25	6.40
62 "	6 "	44	60	54	60	46	380.00	14.75	6.85
64 "	6 "	44	62	56	62	48	425.00	17.60	7.35
66 "	6 "	48	64	58	64	50	470.00	22.00	7.85
68 "	6 "	48	66	60	66	52	520.00	26.40	8.45
70 "	6 "	52	68	62	68	54	570.00	30.80	9.05
72 "	6 "	52	70	64	70	54	620.00	35.20	9.65

One extra set points and two extra shanks given with each saw.

One wrench given with each saw or set of saws.

No extra charge for saws one gauge thicker than list. No extra charge for saws one to three gauges thinner than list. When more than three gauges thinner, add 5 per cent to list for each gauge.

Saws 48 inches and under, and 62 inches and over, in diameter more than two gauges thinner than list not warranted. Saws 50 inches to 60 inches in diameter thinner than 10 gauge not warranted.

Saws 42 inches or less in diameter, beveled one gauge without extra charge; 44 inches or larger, beveled two gauges without extra charge.

For price extra points and shanks see discount sheet.

Simonds Inserted Point Saw

Plain Chisel Teeth, also "IXL" Teeth, full size illustrations. These two styles of teeth are exactly alike in form and outward appearance. The difference in the "IXL" is explained in the diagram at the bottom of this page.

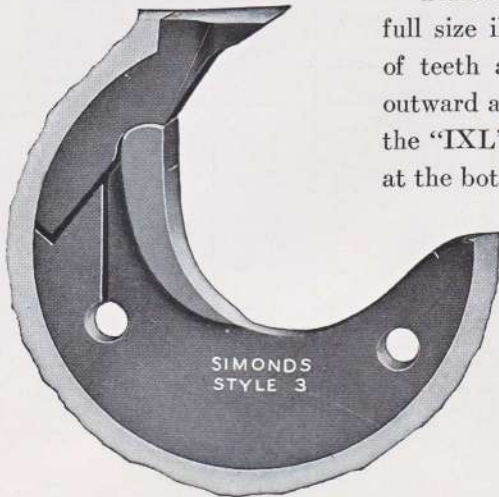

For prices of Simonds Saws fitted with these teeth, see lists on pages 18 and 19.

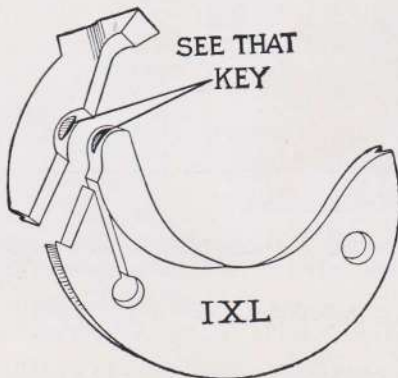

The "IXL" Tooth, which is sold exclusively by the Simonds Company, is equipped with a key on the inner side of the point, as shown in this diagram. This key prevents the point being forced sidewise in the shank.

Simonds Inserted Point Saws

"IXL" Style

For use where larger teeth are wanted we are making styles Nos. 4 and 5. 46 teeth is the greatest number that can be put in a 60-inch No. 4 style saw.



This tooth is used principally on the Pacific Coast. 36 teeth is the greatest number that can be put in a 60-inch No. 5 style saw.

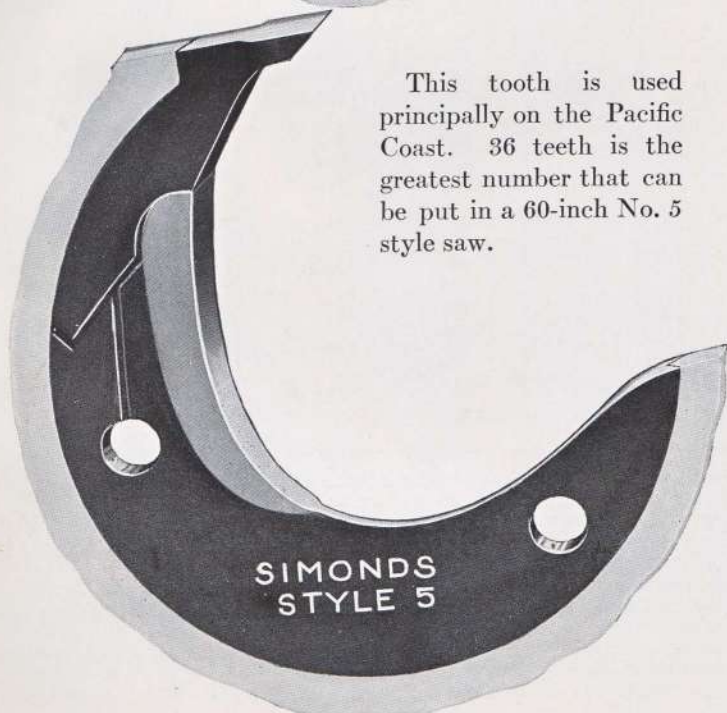

Write for Discounts

Simonds Inserted Point Saws

Style 2¹/₂

Diameter	Thickness	Greatest Number of Teeth that can be put in Saw	Price	Extra for each Gauge Heavier	Price for Beveling New Saws per Gauge
10 inch	12 gauge	10	\$27.00	\$0.20	\$0.45
12 "	11 "	12	32.00	.30	.55
14 "	10 "	14	37.00	.40	.35
16 "	10 "	16	43.00	.50	.75
18 "	10 "	20	49.00	.60	.90
20 "	9 "	22	55.00	.75	1.05
22 "	9 "	24	61.00	.90	1.20
24 "	9 "	26	68.00	1.05	1.35
26 "	9 "	28	75.00	1.25	1.55
28 "	9 "	30	82.00	1.50	1.75
30 "	9 "	32	90.00	1.75	1.95
32 "	8 "	34	100.00	2.00	2.15
34 "	8 "	36	110.00	2.25	2.35
36 "	8 "	38	120.00	2.60	2.55
38 "	8 "	42	130.00	3.00	2.75
40 "	8 "	44	140.00	3.40	2.95
42 "	8 "	46	150.00	3.80	3.25
44 "	8 "	50	165.00	4.40	3.55
46 "	8 "	52	180.00	5.15	3.85
48 "	8 "	54	200.00	5.90	4.15
50 "	8 "	56	220.00	6.65	4.45
52 "	7 "	60	245.00	7.40	4.80
54 "	7 "	62	275.00	8.80	5.15
56 "	7 "	64	310.00	10.25	5.50
58 "	7 "	66	340.00	11.75	5.95
60 "	7 "	70	375.00	13.25	6.40
62 "	6 "	74	420.00	14.75	6.85
64 "	6 "	76	470.00	17.60	7.35
66 "	6 "	78	520.00	22.00	7.85
68 "	6 "	80	575.00	26.40	8.45
70 "	6 "	82	630.00	30.80	9.05
72 "	6 "	84	685.00	35.20	9.65

One extra set points and two extra shanks given with each saw.

One wrench given with each saw or set of saws.

No extra charge for saws one gauge thicker than list. No extra charge for saws one to three gauges thinner than list. When more than three gauges thinner, add 5 per cent to list for each gauge.

Saws 48 inches and under, and 62 inches and over, in diameter more than two gauges thinner than list nor warranted. Saws 50 inches to 60 inches in diameter thinner than 10 gauge not warranted.

Saws 42 inches or less in diameter, beveled one gauge without extra charge; 44 inches or larger, beveled two gauges without extra charge.

For price extra points and shanks see discount sheet.

Simonds Inserted Point Saws

Styles 3, 4, and 5

Diameter	Thickness	Standard Number of Teeth			Greatest Number of Teeth that can be put in Saw			Price	Extra for each Gauge Heavier	Price for Beveling New Saws per Gauge
		3	4	5	3	4	5			
16 inch	10 gauge	12	12	\$39.00	\$0.50	\$0.75
18 "	10 "	14	14	44.00	.60	.90
20 "	9 "	14	16	50.00	.75	1.05
22 "	9 "	16	12	10	18	14	12	56.00	.90	1.20
24 "	9 "	18	14	12	18	16	14	62.00	1.05	1.35
26 "	9 "	18	14	12	20	16	14	68.00	1.25	1.55
28 "	9 "	18	16	14	22	18	14	74.00	1.50	1.75
30 "	9 "	20	16	14	24	20	18	80.00	1.75	1.95
32 "	8 "	22	18	16	26	22	20	88.00	2.00	2.15
34 "	8 "	22	20	18	28	24	20	97.00	2.25	2.35
36 "	8 "	24	20	18	30	26	22	106.00	2.60	2.55
38 "	8 "	24	22	20	32	28	22	115.00	3.00	2.75
40 "	8 "	26	24	20	34	30	24	125.00	3.40	2.95
42 "	8 "	28	26	22	36	32	26	137.00	3.80	3.25
44 "	8 "	30	26	24	38	34	26	150.00	4.40	3.55
46 "	8 "	32	28	24	40	36	28	165.00	5.15	3.85
48 "	8 "	34	30	26	42	36	28	180.00	5.90	4.15
50 "	8 "	36	32	28	44	38	30	200.00	6.65	4.45
52 "	7 "	38	34	30	44	40	32	220.00	7.40	4.80
54 "	7 "	40	36	30	46	42	32	250.00	8.80	5.15
56 "	7 "	42	36	32	48	42	34	280.00	10.25	5.50
58 "	7 "	44	38	34	50	44	36	310.00	11.75	5.95
60 "	7 "	46	40	34	52	46	36	340.00	13.25	6.40
62 "	6 "	48	40	36	54	48	38	380.00	14.75	6.85
64 "	6 "	48	42	36	56	50	38	425.00	17.60	7.35
66 "	6 "	50	44	38	58	52	40	470.00	22.00	7.85
68 "	6 "	52	44	38	60	54	40	520.00	26.40	8.45
70 "	6 "	54	46	42	62	54	44	570.00	30.80	9.05
72 "	6 "	56	48	42	64	56	44	620.00	35.20	9.65

One extra set points and two extra shanks given with each saw.

One wrench given with each saw or set of saws.

No extra charge for saws one gauge thicker than list. No extra charge for saws one to three gauges thinner than list. When more than three gauges thinner, add 5 per cent to list for each gauge.

Saws 48 inches and under, and 62 inches and over, in diameter more than two gauges thinner than list not warranted. Saws 50 inches to 60 inches in diameter thinner than 10 gauge not warranted.

Saws 42 inches or less in diameter, beveled one gauge without extra charge; 44 inches or larger, beveled two gauges without extra charge.

For price extra points and shanks see discount sheet.

Simonds Rift Saws



Diameter	Gauge	4 Teeth	6 Teeth	10 Teeth
14 inch	8	\$22.00	\$27.00
16 "	8	25.00	30.00
18 "	8	28.00	33.00
20 "	8	31.00	36.00	\$44.00
22 "	8	34.00	39.00	47.00
24 "	8	38.00	43.00	51.00
26 "	8	43.00	48.00	56.00
28 "	8	48.00	53.00	61.00
30 "	8	53.00	58.00	66.00

One extra set of points and two shanks furnished with each saw. One wrench furnished with each saw or set of saws.

The standard is 8 gauge but can be supplied in either 9 or 10 gauge. If heavier than standard, advance same as standard Inserted Point Saws.



Simonds Inserted Point Edger Saws

For prices use regular list, page 15

Write for Discounts

Simonds Inserted Tooth Grooving Saws

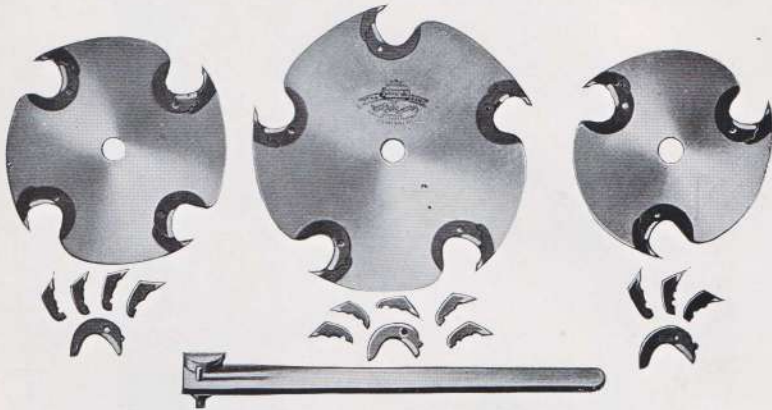

Price List of Simonds Inserted Tooth Grooving Saws

Used for cutting dadoes, and answering the same purpose as a solid tooth grooving saw. The diameter of the saw always remaining the same permits cutting different grooves by simply changing width of points as per list at the bottom of this page.

6 inch	7 gauge	4 teeth	\$13.00
7 "	7 "	5 "	16.00
8 "	7 "	6 "	19.00
9 "	7 "	6 "	21.00
10 "	7 "	8 "	25.00
12 "	7 "	10 "	29.00
14 "	7 "	10 "	33.00
16 "	7 "	12 "	38.00
18 "	7 "	14 "	43.00

Above list covers saws fitted with points to cut $\frac{1}{4}$ in., $\frac{5}{16}$ in., $\frac{3}{8}$ in., $\frac{7}{16}$ in., $\frac{1}{2}$ in., $\frac{9}{16}$ in., $\frac{5}{8}$ in., $\frac{11}{16}$ in., or $\frac{3}{4}$ in.

No extras furnished.

When made with a lesser number of teeth than shown above deduct \$1.00 per tooth from list for each tooth less.

Extra points to cut $\frac{1}{4}$ — $\frac{5}{16}$ — $\frac{3}{8}$ in.	\$ 7.50 per hundred
" " " " $\frac{7}{16}$ or $\frac{1}{2}$ in.	15.00 " "
" " " " $\frac{9}{16}$ or $\frac{5}{8}$ in.	17.50 " "
" " " " $\frac{11}{16}$ or $\frac{3}{4}$ in.	20.00 " "

For price extra shanks see discount sheet.

Simonds Inserted Tooth Cut-Off Saws

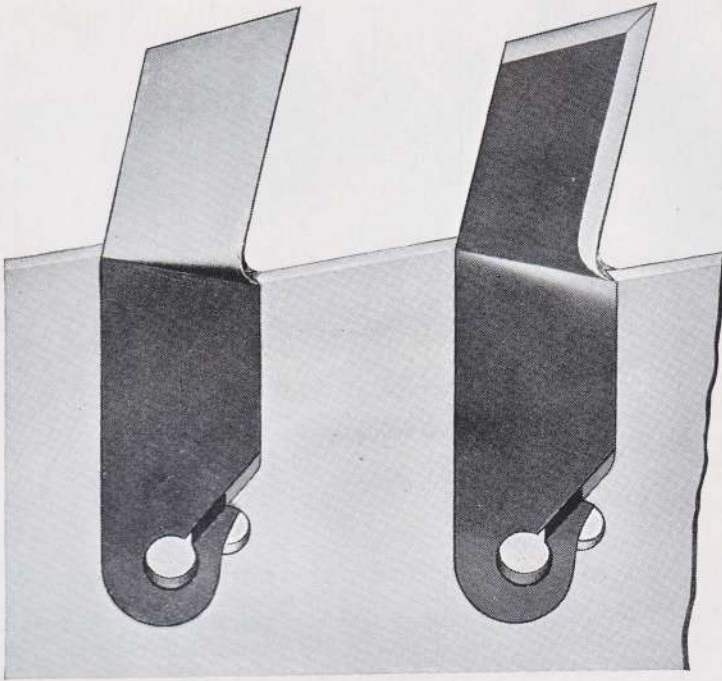

No. 5 Size and Style Tooth with Forward Hook and Spring Lock.

The Tooth that gives the maximum amount of wear.

The Spring Lock at the bottom of the front of the tooth engages a flat surface on the plate and has proven the one most successful method of holding teeth in the plate of an Inserted Tooth Cut-Off Saw.

It is the only saw of the kind the teeth of which do not require some form of rivets, consequently the tension of the Simonds plate is not disturbed by the hammering of rivets, as often happens with other makes. Without rivets, teeth are more easily inserted or removed. When sprung into position they are firmly locked in the plate.

Because of the manner in which they are offset, the teeth may be worn out without resetting. They are provided with ample clearance from the point both downward and backward, the cutting point only coming in contact with the wood. Unnecessary friction is avoided in the Simonds Saw.

The forward hook angle of the teeth can be changed by filing a very slight amount from the point of the tooth at the desired angle. The "V" in the Simonds plate and the grooves in the teeth are machine milled, making mechanically perfect, close fitting joints. Full instructions for inserting and removing teeth are sent with each saw or box of points.

Simonds Inserted Tooth Cut-Off Saws are used chiefly by Pulp Mills and by Shingle and Stave Mills for cutting logs into short lengths or bolts. They may, however, be used for many other cutting-off purposes.

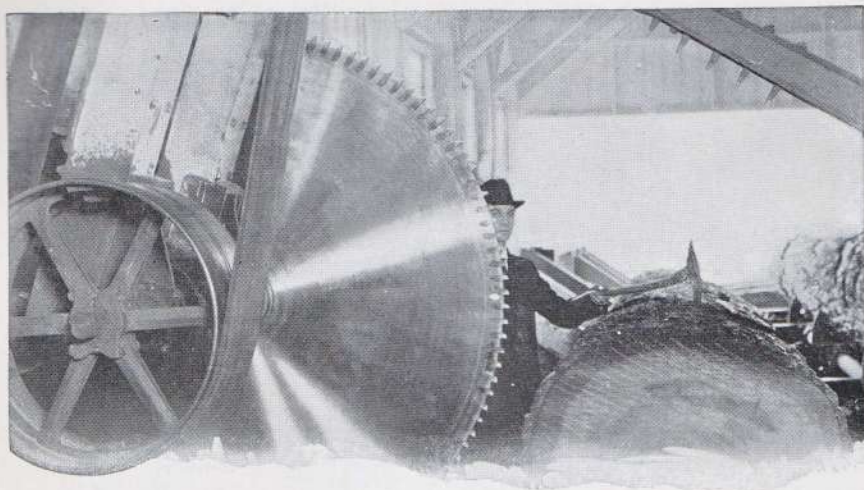

Simonds Inserted Tooth Cut-Off Saws

Price-List

Diameter Inches	Thickness Gauge	Standard No. Teeth	Price Each	Diameter Inches	Thickness Gauge	Standard No. Teeth	Price Each
36	8	60	\$110.00	66	6	114	\$475.00
38	8	62	118.00	68	5	116	520.00
40	8	66	127.00	70	5	120	565.00
42	8	70	139.00	72	5	124	610.00
44	8	74	153.00	74	5	128	675.00
46	8	78	167.00	76	5	132	765.00
48	8	80	182.00	78	5	134	890.00
50	7	84	204.00	80	5	138	1,030.00
52	7	88	232.00	82	5	142	1,170.00
54	7	92	262.00	84	5	146	1,310.00
56	7	96	290.00	86	4	150	1,470.00
58	7	98	320.00	88	4	154	1,650.00
60	6	102	350.00	90	4	156	1,840.00
62	6	106	390.00	92	4	158	2,040.00
64	6	110	430.00	94	4	160	2,280.00
				96	4	162	2,550.00

Saws of odd diameters take price of next larger size.

No extra teeth included in the above prices.

For each tooth inserted in excess of standard, add to list price \$1.65.

No extra charge for saws one gauge thicker than list. If more than one gauge thicker an extra charge will be made for each additional gauge the same as on Solid Tooth Circular Saws.

This type of saw is intended for cutting heavy stock, and is not recommended in small diameters and thin gauges, and therefore is not practical for trimming or equalizing lumber of small timbers.

For price extra teeth see discount sheet.

Right and Left Hand Circular Board Saws

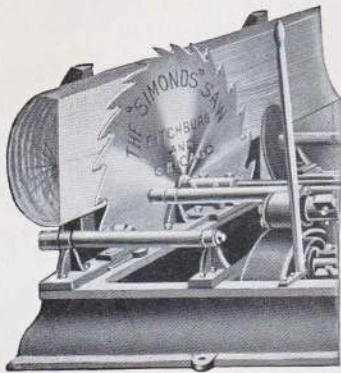

LEFT HAND
SAW

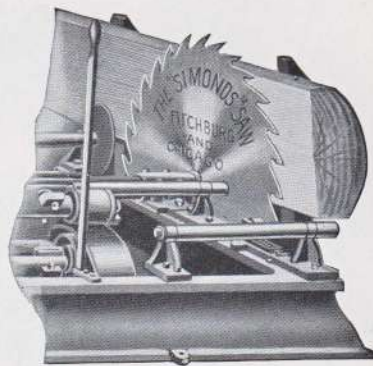

RIGHT HAND
SAW

N. B.—Standing in front of a circular saw (with the saw revolving towards you), if the log passes to the right of the saw it is a **RIGHT HAND Saw**; if to the left, a **LEFT HAND Saw**, as shown above.

Instructions for Ordering Simonds Board Saws

The following information should be given when ordering Circular Head Saws:—

- Number and Style of Saws wanted
- Diameter, inches
- Right or Left Hand
- Thickness of Center, gauge
- Thickness at Rim, gauge
- Number of Teeth, (If possible, give some latitude as to number)
- Size of Mandrel Hole
- Size of Pin Holes
- Distance apart Pin Holes, center to center
- Number of Revolutions per minute
- Greatest Feed each Revolution
- Kind of Timber to be sawed

If convenient, send impression of holes taken on a piece of clean white letter paper by pressing against edge of holes.

If Inserted Point Saws are wanted, state style of tooth whether B, D, F, or plain or IXL style
2½, or 3.

Blanks will be furnished for ordering Saws, upon application.

Do not tear out this page

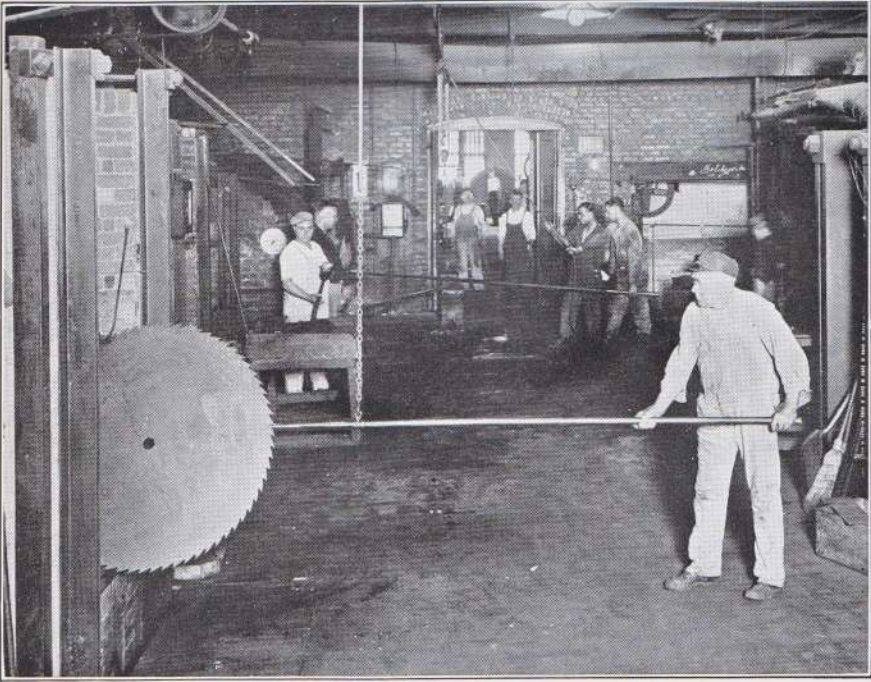

Simonds Circular Saws

Flattened Without Hammering

Such sudden and strenuous changes occur when a Circular Saw plate is hardened by being plunged when red hot into a cold oil solution, that twists and strains in the plate are the inevitable result. These twists must be removed if the plate is to be flat.

Tempering reduces the degree of hardness but does not alter the shape of the plate, at least when done in the ordinary way, which necessitates hammering the plate all over to get it approximately flat. The Simonds method of tempering under pressure flattens the plate at the same time, thus saving the abuse given the metal when flattened under the hammer. The less a saw plate is hammered, the better the finished saw.

Much of the unusual success of Simonds Circular Saws over other brands when operated under the most strenuous mill conditions is due to our scientific method of tempering and flattening under pressure, both operations being done at one and the same time.



This does not mean that a hammer never touches a Simonds Circular plate. The accompanying pictures prove the contrary, as do also our explanations in previous editions of our catalog. The teeth of the saw are punched on a large punch press, then lightly hammered, as indicated in the second picture, to overcome any deviation caused by punching the teeth.

Speed and Tension are put in a finished Circular by hammering. Filers and other Millmen are thoroughly familiar with this process. A plate must be opened up, tensioned, as it is called, throughout a portion between the mandrel hole and the rim, to counter-balance the pull caused by centrifugal force when the saw is speeded up on a mill. The larger the plate and the higher the speed, the greater the required tensioning.

Our method of straightening the saw undoubtedly gives much more strength and standing up quality to a Simonds Saw than any other method ever used. We therefore make the claim that our saws will stand heavier crowding and heavier feed than any other saws on the market.

Know Your Mill

The kind of work done by a Circular Saw depends much on the condition of the mill. Amount of power, alignment of carriage, loose bearings, lost motion, and lead of the blade are questions to be carefully considered in relation to each individual equipment.

**SIMONDS SAWS
PROPERLY HANDLED IN
PERFECTLY GOOD LOGS
MAKE PERFECTLY GOOD
LUMBER**

and that kind of lumber means profit for the Manufacturer.

In order that our saws should be made of steel possessing just the desired analysis, it is necessary for us



to own and operate a modern and thoroughly up-to-date Crucible Steel Mill. This mill is located at Lockport, New York, equidistant from our factories at Fitchburg, Massachusetts, Chicago, Illinois, and Montreal, Quebec. We cordially invite all Millmen when near Lockport to call and see the manufacture of Simonds Steel.

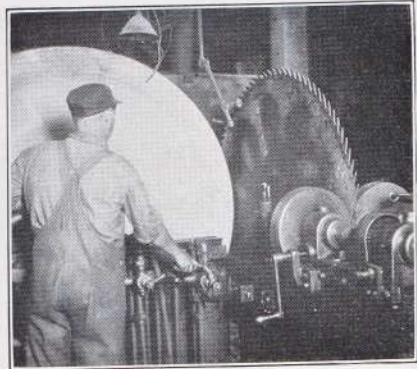

The Average Speed of Circular Saws

Diameter Inches	Revolutions per Minute	Diameter Inches	Revolutions per Minute
8	4,600	40	980
10	3,920	44	890
12	3,260	48	815
16	2,450	52	750
20	1,960	56	700
24	1,630	60	640
28	1,400	64	600
32	1,225	68	560
36	1,080	72	530

The above table is figured on a rim speed of 10,000 feet per minute.



Styles of Circular Saw Teeth

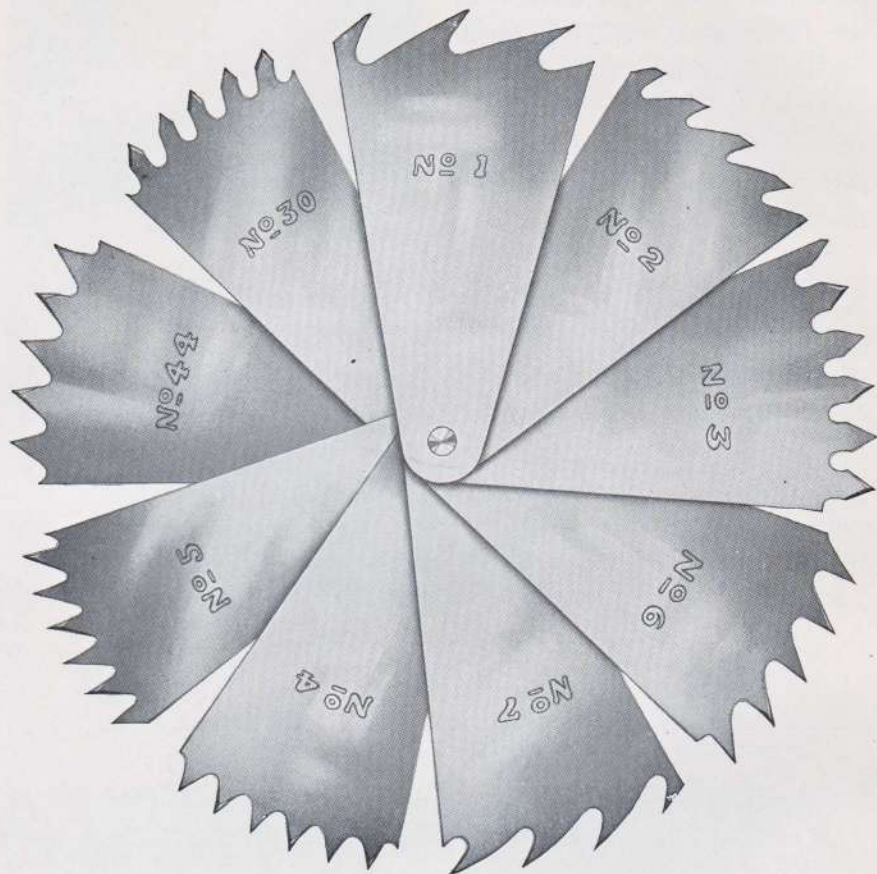

This cut shows a few of the many kinds of Circular Saw Teeth now in use. We make any standard tooth wanted. When ordering, refer to the tooth style number in the above illustration.

As a suggestion for Rip Saws 36-inch and less in diameter, select Style No. 7; over 36-inch in diameter, Style No. 1. For Cut-off Saws, Trimmers and Slashers, Style No. 4. Pacific Coast Cut-off Saws, Style No. 44. For Cordwood Saws, select Style No. 5.

Solid Tooth Circular Saws

Filed and Set Ready for Use

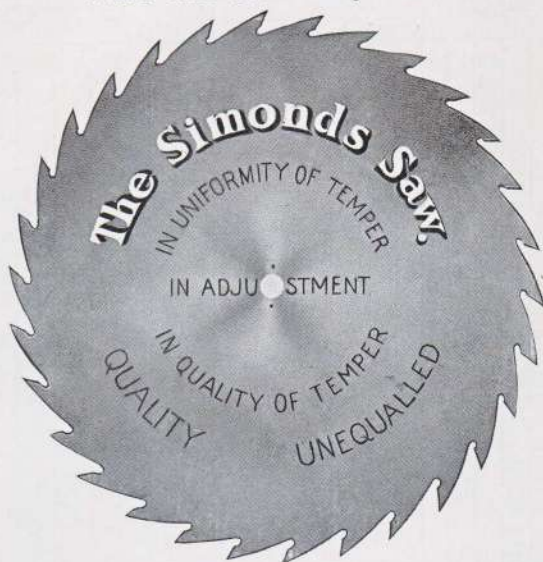

Diameter Inches	Thickness Gauge	Size Hole Inches	Price Each	Extra for Each Gauge Heavier	Beveling New Saws Per Gauge
6	18	$\frac{3}{4}$	\$3.30	\$0.07	\$0.25
8	18	$\frac{7}{8}$	4.40	.10	.35
10	16	1	5.60	.20	.45
12	15	1	7.00	.30	.55
14	14	$1\frac{1}{8}$	8.50	.40	.65
16	14	$1\frac{1}{8}$	10.50	.50	.75
18	13	$1\frac{1}{4}$	12.50	.60	.90
20	13	$1\frac{5}{16}$	15.00	.75	1.05
22	12	$1\frac{5}{16}$	17.50	.90	1.20
24	11	$1\frac{3}{8}$	20.50	1.05	1.35
26	11	$1\frac{3}{8}$	24.00	1.25	1.55
28	10	$1\frac{1}{2}$	28.00	1.50	1.75
30	10	$1\frac{1}{2}$	32.00	1.75	1.95
32	10	$1\frac{5}{8}$	36.50	2.00	2.15
34	9	$1\frac{5}{8}$	41.00	2.25	2.35
36	9	$1\frac{5}{8}$	47.00	2.60	2.55
38	9	$1\frac{5}{8}$	54.00	3.00	2.75
40	9	2	62.00	3.40	2.95
42	8	2	71.00	3.80	3.25
44	8	2	83.00	4.40	3.55
46	8	2	98.00	5.15	3.85
48	8	2	112.00	5.90	4.15
50	7	2	127.00	6.65	4.45
52	7	2	142.00	7.40	4.80
54	7	2	157.00	8.80	5.15
56	7	2	180.00	10.25	5.50
58	7	2	200.00	11.75	5.95
60	6	2	224.00	13.25	6.40

Write for Discounts

Solid Tooth Circular Saws—Continued

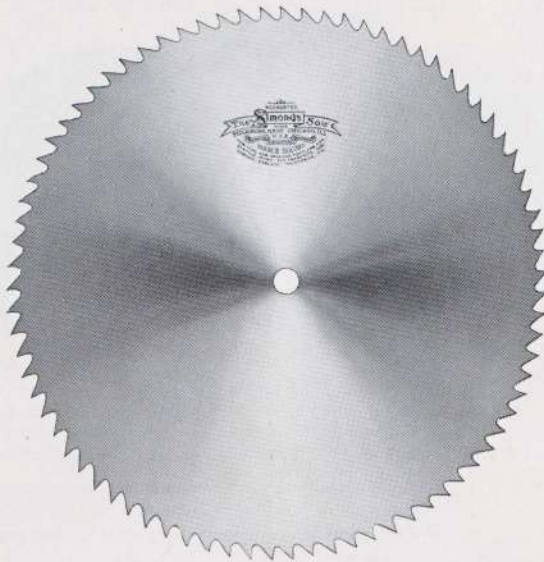

Diameter Inches	Thickness Gauge	Size Hole Inches	Price Each	Extra for Each Gauge Heavier	Beveling New Saws Per Gauge
62	6	2	250.00	14.75	6.85
64	6	2	280.00	17.60	7.35
66	6	2	310.00	22.00	7.85
68	5	2	350.00	26.40	8.45
70	5	2	400.00	30.80	9.05
72	5	2	450.00	35.20	9.65
74	5	2	510.00	39.60	10.30
76	5	2	575.00	44.00	11.00
78	5	2	690.00	49.85	11.85
80	5	2	810.00	55.75	12.90
82	5	2	940.00	63.05	14.10
84	5	2	1,075.00	70.40	15.40

All saws less than 6 inches in diameter take list of 6 inch saw.

All saws filed and set ready for use.

All saws of odd diameters not listed take list of next larger size.

No extra charge for saws one gauge thicker than list.

No extra charge for saws one to three gauges thinner than list; when more than three gauges thinner than list, add 5 per cent for each gauge.

Saws 48 inches and under, and 62 inches and over, in diameter, more than two gauges thinner than list, not warranted. Saws 50 inches to 60 inches in diameter thinner than 10 gauge not warranted.

Saws 42 inches or less in diameter beveled one gauge without extra charge; 44 inches or larger beveled two gauges without extra charge.

Saws hollow or concave ground, add for each gauge hollow or concave ground, double the list for beveling.

Saws for cutting Bone, Horn, or Ivory, add 50 per cent to the above list. When these saws are hollow or bevel ground, the 50 per cent advance is to apply only on the list of a straight gauge saw, and not on the extras for hollow or bevel grinding.

Write for Discounts

Shingle and Heading Saws



LEFT HAND SAW



RIGHT HAND SAW

Diameter	Price Each	Diameter	Price Each
36 inch	\$62.00	48 inch	\$145.00
38 "	70.00	50 "	170.00
40 "	80.00	52 "	200.00
42 "	95.00	54 "	230.00
44 "	110.00	56 "	260.00
46 "	125.00	58 "	290.00
		60 "	320.00

Above list is for saws beveled not more than 8 gauges, and with thickness at center of the same gauge as shown in Solid Tooth Circular Saw list for saws of same diameter, but one gauge thicker is allowed without extra charge.

For any additional thickness or beveling, add for each gauge thicker or gauge beveling as per Solid Tooth Circular Saw list.

When ordering Shingle or Heading Saws give the following specifications: diameter of saw in inches; thickness or gauge at center and at rim; number of teeth; right or left hand; speed of saw; name of maker of machine and size of flange.

If new flange is required, send full size template of old flange, showing size and location of all holes.

If saw only is required, send the old flange to us to be fitted to the saw, or if this cannot be done, send template of holes and a sample screw by which to drill and countersink saw.

Collars for Shingle and Heading Saws or Resaws

New Cast Iron Flanges for standard makes of shingle machines fitted to new saws. Price on application.

New Steel Flanges 8 inches to 26 inches in diameter, $\frac{3}{8}$ inch thick or less, fitted to new saws, either with screws or rivets. Price on application.

Fitting old flanges to new saws, \$8.00 each.

Lock Corner Cutters

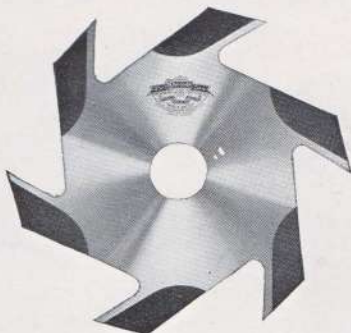

Lots of less than 10, Groover Saw list plus 35 cents per tooth for scarfing.
 Lots of 10 or more, Groover Saw list plus 20 cents per tooth for scarfing.
 Addition subject to same discount as saws.
 All Lock Corner Cutters are furnished with teeth scarfed as shown above.

Grooving Saws

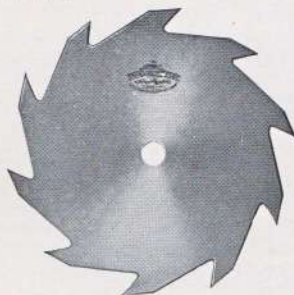

Diam. Inch	No. of Teeth	Thickness								
		1/8"	3/16"	1/4"	5/16"	3/8"	7/16"	1/2"	5/8"	3/4"
4	5	\$3.60	\$3.80	\$6.20	\$7.00	\$8.00	\$8.80	\$9.60	\$14.00	\$14.60
5	6	4.20	4.40	7.20	8.00	9.20	10.20	11.20	16.80	17.80
6	8	5.20	5.40	8.20	9.20	10.40	11.60	12.80	19.60	21.00
7	8	6.00	6.40	9.20	10.40	11.60	13.00	14.40	22.80	23.60
8	10	6.80	7.40	10.20	11.60	13.20	14.80	16.40	26.00	27.00
9	10	7.40	8.40	11.40	13.00	14.80	16.60	18.40	29.20	31.00
10	10	8.20	9.40	12.60	14.40	16.40	18.40	20.40	33.40	35.00
11	11	10.60	11.80	14.00	16.80	18.80	21.00	22.40	36.60	39.00
12	12	11.60	12.80	15.40	19.20	21.40	23.60	24.80	39.80	43.00
14	14	13.80	15.40	17.80	22.20	26.00	28.20	29.80	45.00	49.80
16	16	15.40	18.40	21.20	26.00	30.60	33.40	35.60	53.00	59.00

All Grooving Saws under 4 inches in diameter take 4 inch list.

Beveled Grooving Saws, add 10 per cent to above prices.

Grooving Saws with teeth shaped and backed off, add 50 per cent to above prices.

Special Grooving Saws made to order, special prices.

Simonds Groover or Dado Head

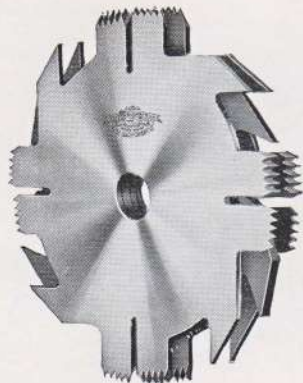

Assembled Dado Head



Inside Cutter

This dado or groover head cuts grooves from $\frac{1}{8}$ to 2 inches wide in the sets listed and wider grooves can be obtained by inserting inside cutters.

Each outside cutter is $\frac{1}{8}$ inch wide and is a groover in itself. A single cutter will cut grooves $\frac{1}{8}$ inch wide and the two cutters will cut grooves $\frac{1}{4}$ inch wide.

By using inside cutters, grooves measurable by sixteenths can be obtained beyond the $\frac{1}{8}$ and $\frac{1}{4}$ inch cuts made by the outside cutters.

This tool cuts a clean groove in any direction in the wood and is easily kept in order.

Inside cutters and rakers on the outside cutters should be filed slightly below the marker or cutting points on the outside cutters.

The following shows width of cuts and number of cutters in each set.

Number	Outside Cutters	Inside Cutters		
		$\frac{1}{8}$ "	$\frac{1}{4}$ "	$\frac{1}{2}$ "
Set No. 1 cuts $\frac{1}{8}$ ", $\frac{1}{4}$ ", by eighths to $\frac{3}{8}$ "	2		1	
Set No. 2 cuts $\frac{1}{8}$ ", $\frac{1}{4}$ ", by eighths to $\frac{5}{8}$ "	2		1	1
Set No. 3 cuts $\frac{1}{8}$ ", $\frac{1}{4}$ ", by sixteenths to $\frac{3}{4}$ "	2	2	1	1
Set No. 4 cuts $\frac{1}{8}$ ", $\frac{1}{4}$ ", by sixteenths to 1"	2	2	1	2
Set No. 5 cuts $\frac{1}{8}$ ", $\frac{1}{4}$ ", by sixteenths to $1\frac{1}{2}$ "	2	2	1	4
Set No. 6 cuts $\frac{1}{8}$ ", $\frac{1}{4}$ ", by sixteenths to 2"	2	2	1	6
Set No. 7 cuts $\frac{1}{8}$ ", $\frac{1}{4}$ ", to 3" wide	2	2	1	10
Set No. 8 cuts $\frac{1}{8}$ ", $\frac{1}{4}$ ", to 4" wide	2	2	1	14

LIST PRICES.

Diameter, inches	6	7	8	9	10	11	12	14	16
Set No. 1	\$11.50	\$13.15	\$14.85	\$16.50	\$19.00	\$21.65	\$25.15	\$29.65	\$34.50
Set No. 2	13.85	15.65	17.50	19.35	22.00	24.85	28.65	34.00	39.85
Set No. 3	16.60	18.65	20.85	23.00	26.00	29.15	33.35	39.35	45.65
Set No. 4	18.90	21.15	23.50	25.85	29.00	32.35	36.85	43.65	51.00
Set No. 5	23.60	26.15	28.85	31.50	35.00	38.65	43.85	52.35	61.65
Set No. 6	28.25	31.15	34.15	37.15	41.00	45.00	50.85	61.00	72.35
Set No. 7	37.60	41.15	44.85	48.50	53.00	57.65	64.85	78.35	93.65
Set No. 8	46.90	51.15	55.50	59.85	65.00	70.35	78.85	95.65	115.00

Outside Cutters, each.

Diameter, inches	6	7	8	9	10	11	12	14	16
$\frac{1}{8}$ in. thick	4.90	5.65	6.40	7.15	8.35	9.60	11.25	13.35	15.70

Inside Cutters, each.

Diameter, inches	6	7	8	9	10	11	12	14	16
$\frac{1}{16}$ in. thick	1.10	1.20	1.35	1.50	1.65	1.85	2.00	2.35	2.65
$\frac{1}{8}$ in. thick	1.65	1.85	2.00	2.15	2.35	2.50	2.65	3.00	3.15
$\frac{1}{4}$ in. thick	2.35	2.50	2.65	2.85	3.00	3.15	3.50	4.35	5.35

Write for Discounts

Concave Saws



LEFT HAND SAW



RIGHT HAND SAW

When ordering Concave Saws give circle to be dished to; or give the diameter of the old saw and the amount of drop in the old saw, accurately measured; also give the greatest diameter of the heading to be cut. State which side is to be dished or concaved, right or left hand, as the saw runs towards you.

6 inch	16 gauge	\$6.00;	for each additional gauge	\$0.10 extra
7 "	15 "	6.80;	" "	.12 "
8 "	15 "	7.60;	" "	.15 "
9 "	15 "	8.50;	" "	.20 "
10 "	14 "	9.50;	" "	.25 "
11 "	14 "	10.50;	" "	.30 "
12 "	14 "	11.60;	" "	.40 "
14 "	13 "	13.50;	" "	.55 "
16 "	13 "	15.50;	" "	.70 "
18 "	12 "	17.80;	" "	.85 "
20 "	12 "	20.50;	" "	1.00 "

Saws concaved to a circle 16 inches and under, advance 20 per cent. Extra sizes made to order.

Write for Discounts

Simonds Circular Mitre and Novelty Saws



MITRE

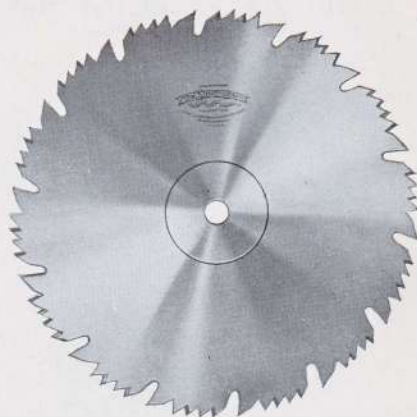

NOVELTY

Mitre and Novelty Saws are both ground tapering to the collar, to run without set and provide ample clearance. They are especially adapted to smooth, clean cutting, such as cabinet and cigar-box work. Novelty Saws will not cut as fast as saws with ordinary splitting or cutting-off teeth, and their use is not advised when crowding the work is considered of more importance than smoothness in finish.

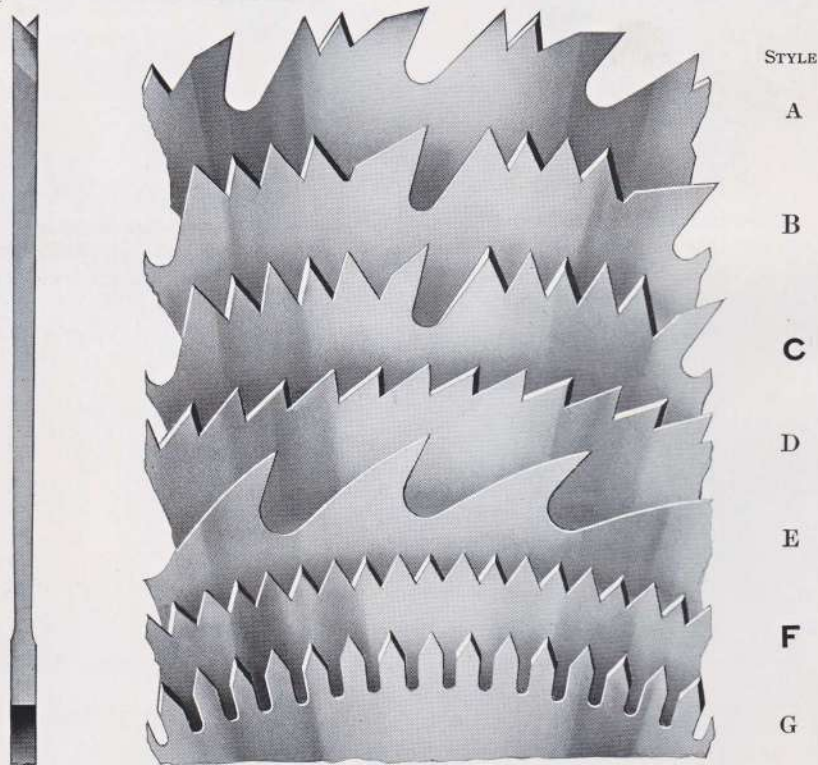

Saws furnished with any of the styles of teeth illustrated above. We can make to order practically any other style tooth desired. Unless otherwise specified, Style C is furnished on Novelty Saws.

Simonds Circular Mitre and Novelty Saws

Novelty Saws are made for either cutting off or ripping.
When ordering specify which is desired.

SIMONDS
STANDARDS

Saws specified by the majority of the trade on which prompt shipment is made

LIST PRICES

Diam. Inches	Gauge at Hole	Gauge at Edge of Collar	Gauge at Teeth	Extra for Each Gauge Heavier	Extra for Each Additional Gauge Concaving	Price Each
6	17	20	17	\$0.07	\$0.50	\$5.40
8	16	19	16	.10	.70	6.80
10	15	18	15	.20	.90	8.60
12	14	17	14	.30	1.10	10.60
14	13	16	13	.40	1.30	12.60
16	13	16	13	.50	1.50	14.80
18	12	15	12	.60	1.80	17.40
20	12	15	12	.75	2.10	20.60
22	11	14	11	.90	2.40	24.20
24	11	14	11	1.05	2.70	28.00

Size Collar Inches	Mitre		Novelty
	Teeth	Style Tooth	Style Tooth
2½	150	F	C
3¼	150	F	C
3½	150	F	C
4	150	F	C
4½	200	F	C
5	200	F	C
5½	200	F	C
6	250	F	C
6½	250	F	C
7	250	F	C

Above list includes filing teeth so that saw is ready for use.

We do not recommend Circular Mitre Saws of thinner gauge than listed.

Thin Rim Special Ground Circular Saws

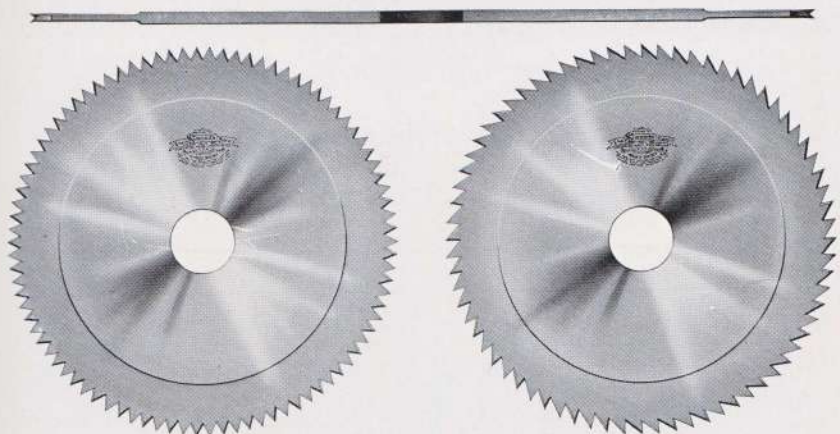

CUT-OFF TOOTH

RIP TOOTH

These saws, as may be seen in the sectional view, are ground very thin for a short distance back from the teeth, and the body of the saw is much thicker, to give strength and stiffness. They are made with either cut-off or rip teeth, for very fine, smooth, light cutting. These saws take the Novelty Saw Price List printed above.

Resawing or Siding Saws

Diameter Inches	Gauge	Price	Diameter Inches	Gauge	Price
16	13 × 17	\$12.75	28	9 × 13	\$33.25
16	12 × 16	13.25	28	9 × 14	35.00
16	11 × 15	13.75	28	8 × 13	36.50
18	12 × 16	15.20	30	9 × 13	37.85
18	11 × 15	15.80	30	9 × 14	39.80
18	12 × 17	16.10	30	8 × 13	41.55
20	12 × 16	18.15	32	9 × 13	42.95
20	11 × 15	18.90	32	9 × 14	45.10
20	12 × 17	19.20	32	8 × 13	47.10
22	11 × 15	21.10	34	9 × 13	48.05
22	10 × 14	22.00	34	8 × 13	50.40
22	11 × 16	22.30	34	8 × 14	52.75
24	10 × 14	24.55	36	8 × 13	57.20
24	9 × 13	25.60	36	8 × 14	59.75
24	10 × 15	25.90	36	7 × 14	64.90
26	10 × 14	28.65	38	8 × 12	62.25
26	9 × 13	29.90	38	8 × 13	65.00
26	10 × 15	30.20	38	7 × 13	70.75

NOTE. — List prices of all resaws are figured by using Solid Tooth Circular Saw list adding extra gauges heavy and gauges beveling, allowing one gauge heavier than standard and one gauge beveling without extra charge.

Edger Saws (Solid Tooth)

Diameter Inches	PRICE				
	Gauge 8	Gauge 9	Gauge 10	Gauge 11	Gauge 12
12	\$8.80	\$8.50	\$8.20	\$7.90	\$7.60
14	10.50	10.10	9.70	9.30	8.90
16	13.00	12.50	12.00	11.50	11.00
18	14.90	14.30	13.70	13.10
20	18.00	17.25	16.50
22	20.20	19.30	18.40
24	22.60	21.55	20.50

Write for Discounts

Circular Saws for Sawing Slate

Tempered and Hollow Ground					Unground				
Diameter Inches	Thickness		Price	Extra for Ea. Ga. Heavier	Diameter Inches	Thickness		Price	Extra for Ea. $\frac{1}{2}$ " Heavier
	Gauge	Inch				Gauge	Inch		
14	10	$\frac{1}{8}$	\$7.00	\$.35	36	4	$\frac{15}{16}$	\$26.00	\$2.30
16	10	$\frac{1}{8}$	8.50	.40	38	4	$\frac{15}{64}$	29.00	2.55
18	9	$\frac{5}{32}$	10.50	.50	40	4	$\frac{15}{64}$	32.00	2.85
20	8	$\frac{11}{64}$	13.50	.65	42	3	$\frac{17}{64}$	38.00	3.15
22	7	$\frac{3}{16}$	16.00	.80	44	3	$\frac{17}{64}$	40.00	3.45
24	6	$\frac{13}{64}$	20.00	1.00	46	3	$\frac{17}{64}$	42.00	3.75
26	6	$\frac{13}{64}$	23.00	1.20	48	2	$\frac{9}{32}$	47.00	4.10
Straight Ground					36	0	$\frac{11}{32}$	34.00	
14	10	$\frac{1}{8}$	4.50	.25	38	0	$\frac{11}{32}$	38.00	
16	10	$\frac{1}{8}$	5.00	.30	40	0	$\frac{11}{32}$	42.00	
18	9	$\frac{5}{32}$	6.50	.35	42	0	$\frac{11}{32}$	45.00	
20	8	$\frac{11}{64}$	8.00	.40	44	0	$\frac{11}{32}$	49.00	
22	7	$\frac{3}{16}$	10.00	.50	46	0	$\frac{11}{32}$	53.00	
24	6	$\frac{13}{64}$	12.00	.60	48	0	$\frac{11}{32}$	57.00	
26	6	$\frac{13}{64}$	14.00	.75	36	00	$\frac{3}{8}$	37.00	
28	5	$\frac{7}{32}$	16.00	.90	38	00	$\frac{3}{8}$	41.00	
30	5	$\frac{7}{32}$	19.00	1.10	40	00	$\frac{3}{8}$	45.00	
32	5	$\frac{7}{32}$	22.00	1.25	42	00	$\frac{3}{8}$	49.00	
34	5	$\frac{7}{32}$	25.00	1.40	44	00	$\frac{3}{8}$	53.00	
					46	00	$\frac{3}{8}$	57.00	
					48	00	$\frac{3}{8}$	61.00	

Lathe Saws

For Roughing Handles

Diam. Inches	Gauge	Price Each	Extra for Each Additional Gauge (heavier)	Diam. Inches	Gauge	Price Each	Extra for Each Additional Gauge (heavier)
8	9	\$3.40	\$0.20	14	6	\$6.00	\$0.35
9	8	3.60	.20	15	5	6.60	.40
10	7	4.00	.25	16	5	7.40	.40
11	7	4.40	.30
12	6	4.80	.30
13	6	5.40	.35

All Lathe Saws less than 8 inches in diameter take list of 8 inch saw.

Write for Discounts

Repairing Circular I. P. Saws



Inserted Point Saws with broken shoulders can be repaired. The illustration above shows an Inserted Point Saw that had several shoulders broken entirely off in an accident.

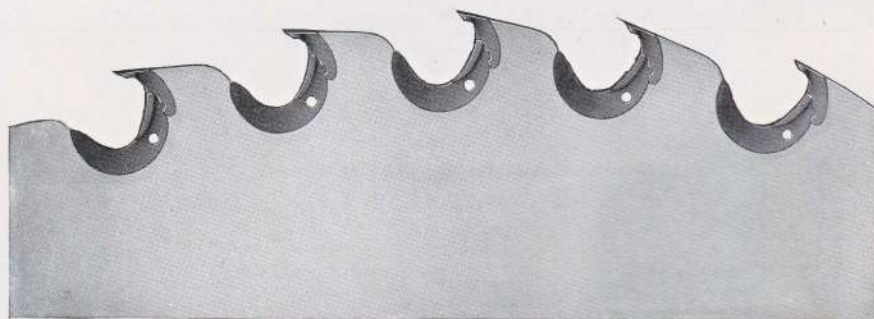

Here is the same saw with new shoulders welded on. This saw is now ready for use and will cut just the same as if no accident had occurred. Send us your broken saws. Let us look them over. We will tell you just what needs to be done and let you know the cost. No saws will be repaired until the owners order to proceed is received. Be sure your name and address is on each saw.

Repairing Circular Saws

Diameter	Hammering	Gumming and Hammering	Retooling and Hammering	Grinding		Setting and Sharpening	
				First Gauge	Each Additional Gauge	Cut-off Saws	Rip Saws
6 inch	\$0.45	\$0.55	\$0.75	\$0.65	\$0.35	\$0.45	\$0.35
8 "	.55	.75	1.00	.85	.55	.55	.40
10 "	.75	1.00	1.30	1.05	.75	.65	.50
12 "	.90	1.35	1.60	1.15	.85	.75	.60
14 "	1.05	1.60	1.90	1.35	1.00	.85	.70
16 "	1.20	1.80	2.20	1.60	1.15	.95	.80
18 "	1.45	2.10	2.55	1.95	1.30	1.05	.90
20 "	1.65	2.50	2.95	2.20	1.45	1.15	1.00
22 "	1.90	2.85	3.30	2.40	1.60	1.30	1.10
24 "	2.10	3.25	3.70	2.70	1.75	1.45	1.20
26 "	2.40	3.70	4.20	3.00	1.90	1.60	1.30
28 "	2.70	4.15	4.75	3.40	2.05	1.75	1.40
30 "	3.00	4.60	5.35	3.75	2.20	1.95	1.50
32 "	3.30	5.05	6.00	4.15	2.35	2.15	1.60
34 "	3.70	5.55	6.90	4.50	2.55	2.35	1.75
36 "	4.30	6.15	7.80	4.90	2.80	2.55	1.90
38 "	4.80	7.00	9.00	5.25	3.00	2.75	2.05
40 "	5.55	8.05	10.20	5.65	3.30	2.95	2.20
42 "	6.30	9.15	11.55	6.00	3.60	3.15	2.35
44 "	7.05	10.35	13.05	6.45	4.05	3.35	2.50
46 "	7.95	11.80	14.70	7.00	4.50	3.60	2.65
48 "	8.85	13.20	16.50	7.60	4.95	3.80	2.85
50 "	9.75	14.65	18.40	8.25	5.40	4.10	3.05
52 "	10.65	16.05	20.25	9.00	5.95	4.40	3.25
54 "	11.55	17.55	22.15	9.90	6.30	4.70	3.50
56 "	12.45	19.05	24.00	10.90	6.75	5.00	3.75
58 "	13.50	20.70	25.90	12.00	7.20	5.30	4.00
60 "	14.70	22.50	27.75	13.20	7.75	5.60	4.25
62 "	15.90	24.30	30.40	14.40	8.25	6.00	4.50
64 "	17.10	26.10	33.00	15.60	8.85	6.30	4.75
66 "	18.30	27.90	35.65	16.80	9.45	6.60	5.00
68 "	19.50	29.70	38.25	18.00	10.15	6.90	5.25
70 "	20.50	31.50	40.90	19.50	11.05	7.20	5.50
72 "	21.90	33.30	43.50	21.00	12.00	7.50	5.75
74 "	23.10	35.10	46.15	22.50	13.15	7.80	6.00

Saws smaller than 6 inches take 6 inch price.

Saws of odd diameter, take the price of next larger size.

When saw is ground, add price of hammering to price of grinding. Gumming and retooling prices cover sizes of saws after they have been repaired. All breakages at risk of owner.

Burned Saws. We repair burned saws at two-thirds price of new ones, which includes retempering, grinding, hammering, polishing, etc.

Changing Solid Saws to Inserted Point Saws. For changing Solid Saws into Inserted Point Saws, \$2.00 per tooth plus one-half the list price of Solid Tooth Saws of same size, this price being based on size the saw will cut to, and subject to same discount as Inserted Point Saws. Same extras furnished as with a new saw.

Changing Solid Saws into Inserted Tooth Cut-off Saws, charge is \$1.65 per tooth plus one-half the list price of a Solid Tooth Saw of same size. The price is based on the size the saw will finish after cutting down, and is subject to the same discount as Inserted Tooth Cut-off Saws.

Repairing burned Inserted Point Saws, two-thirds the price of a new Solid Tooth Saw of the same diameter, plus 30 cents per tooth. Add for any points and shanks inserted at regular prices. No extras furnished.

Single and other thin bevel saws generally will not permit being retempered.

All repairs are at risk of owner, but no charge will be made in case of failure.

Owner's name should appear on each package or board to insure identification at the factory.

Net Weight of Circular Saws

The weights as given below are approximately correct for both Solid and Inserted Tooth Saws.

Diam.	Gauge	WEIGHT		Diam.	Gauge	WEIGHT	
		Lbs.	Oz.			Lbs.	Oz.
6	18		6	34	9	36	
8	18		11	34	10	32	
10	14	1	12	36	8	45	
10	15	1	9	36	9	40	
10	16	1	6	36	10	37	
10	17	1	4	38	8	49	
12	12	3		38	9	45	
12	13	2	12	38	10	41	
12	14	2	8	40	8	54	
12	15	2	4	40	9	48	
12	16	2		40	10	45	
14	12	4	4	42	7	66	
14	13	4		42	8	62	
14	14	3	4	42	9	57	
14	15	2	12	44	7	72	
16	12	6		44	8	65	
16	13	5		44	9	60	
16	14	4	6	46	7	80	
16	15	3	12	46	8	72	
18	11	8		46	9	67	
18	12	7		48	7	84	
18	13	6	6	48	8	80	
18	14	5	9	48	9	75	
18	15	4	12	50	6	104	
20	10	10	12	50	7	96	
20	11	10		50	8	90	
20	12	9		52	6	115	
20	13	8		52	7	104	
20	14	6	12	52	8	96	
22	10	13	4	54	6	122	
22	11	12	12	54	7	111	
22	12	11		54	8	100	
22	13	9	9	56	6	136	
24	10	15	9	56	7	116	
24	11	14	4	56	8	108	
24	12	13		58	6	142	
24	13	11	12	58	7	128	
26	10	18	9	58	8	120	
26	11	16	12	60	5	166	
26	12	16		60	6	152	
28	9	24		60	7	136	
28	10	22		62	5	180	
28	11	19		62	6	163	
30	9	27		62	7	150	
30	10	25		64	5	185	
30	11	23		64	6	167	
32	9	31		64	7	156	
32	10	28		66	5	200	
32	11	24		66	6	180	
34	8	40		72	5	240	
				72	6	224	

Simonds Wide Band Saws



Our Wide Band Saws are Universally
Recognized as More Economical
They Will Cut More Lumber
They Will Hold Their Edge } Longer
They Will Hold Their Tension }
THAN
OTHER
SAWS

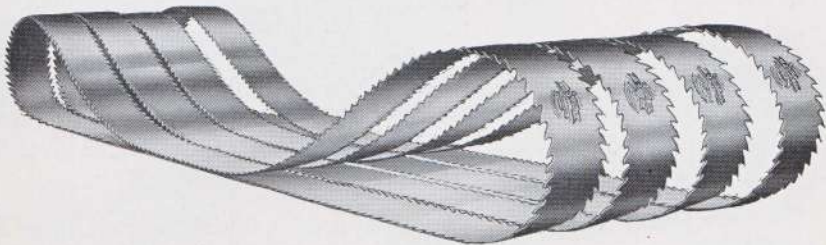

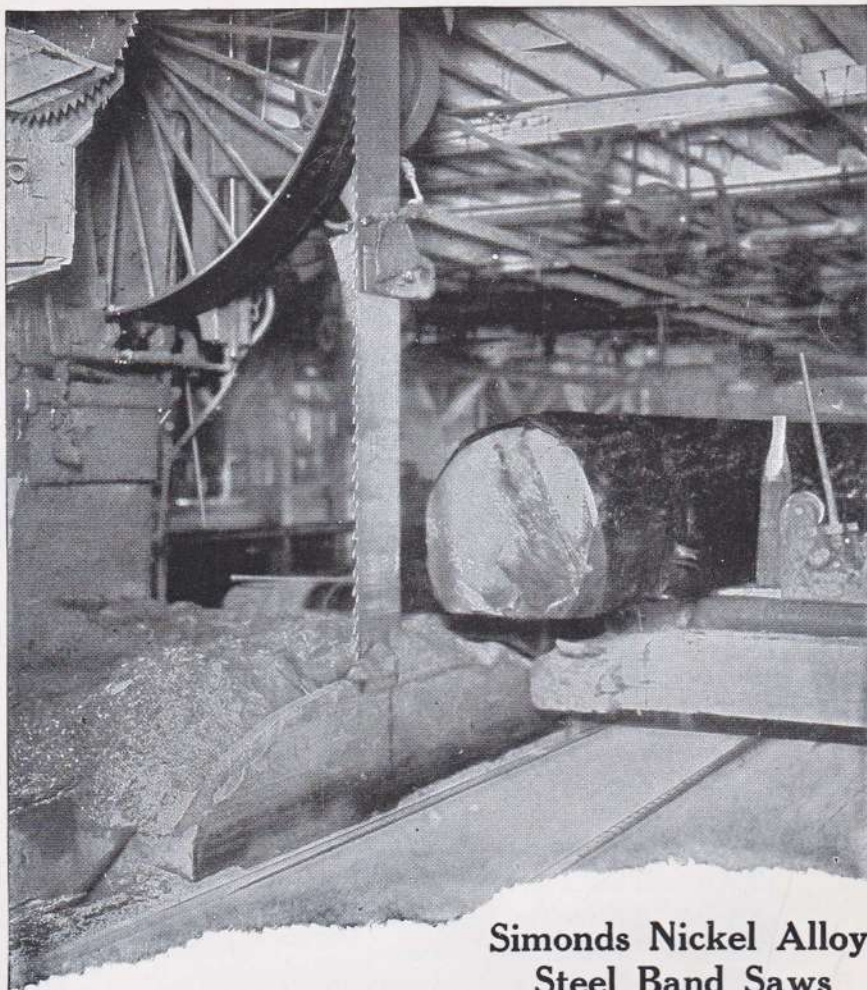

Simonds Nickel Alloy Steel Band Saws

The prospective purchaser of any article desires to know its value as compared with competitive articles in the same class.

The steel for Simonds Band Saws is made by using a high percentage of new Swedish iron together with such alloys as will give the greatest toughness and keenness of cutting edge, the principal of which, in Band Saws, is nickel. It is well known among steel experts that nickel gives to certain steels a toughness not obtainable by any other alloy.

We have found that the resistance required in Band Saws can best be obtained by a liberal use of this alloy — nickel. Any one can use it, but few are doing so, owing to the added cost per pound of the steel.

Simonds Manufacturing Company have been putting out nickel alloy steel Band Saws for a dozen or more years. No matter what the price of competitive saws may be, if they are not made of nickel alloy steel they are dear in comparison. We advise our clients to demand nickel alloy steel for their Band Saws whether they buy them of us or of any one else.

As the saws are ground with practically no variation in gauge throughout the entire length of the saw, Filers and Mechanics will readily appreciate that with this accuracy of manufacture the saw can be kept in such condition that the strains will be divided equally throughout the saw, and consequently add life and durability.

In combining this care of manufacture with the Simonds process of tempering, the toughness of the steel, the quality of the cutting edge,

**We challenge the world to produce a Band Saw
any better or even as good as Simonds**

Our own tests, and the letters which we are furnished from many mills where our saws have been used in competition with other makes, seem to fully warrant our claim that the Simonds Band Saws are tougher, will hold their tension longer, stand more feed, and do more work than any other saw on the market. Prove these facts to your own satisfaction and you will agree with us that the Simonds is the most economical Band Saw.

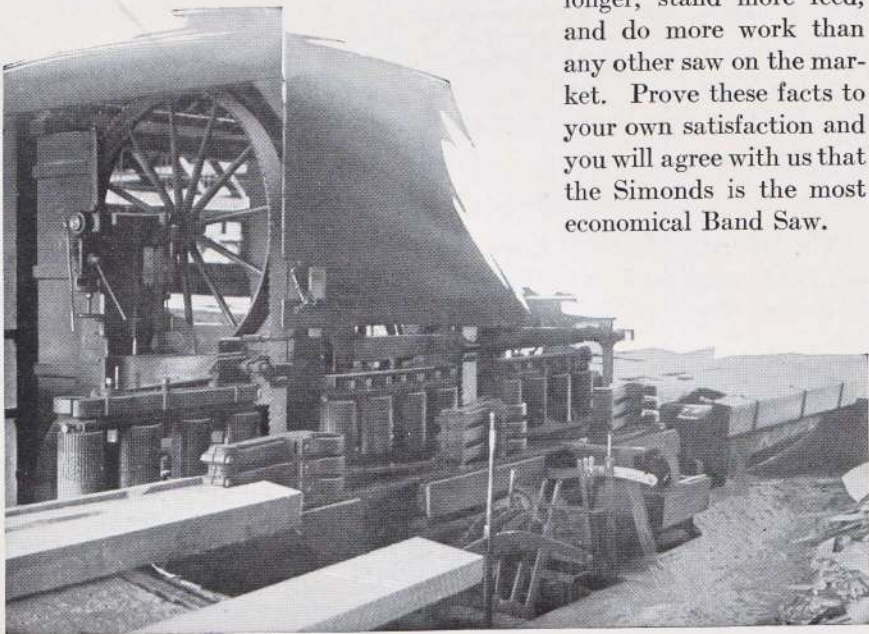

Simonds Narrow Band Saws

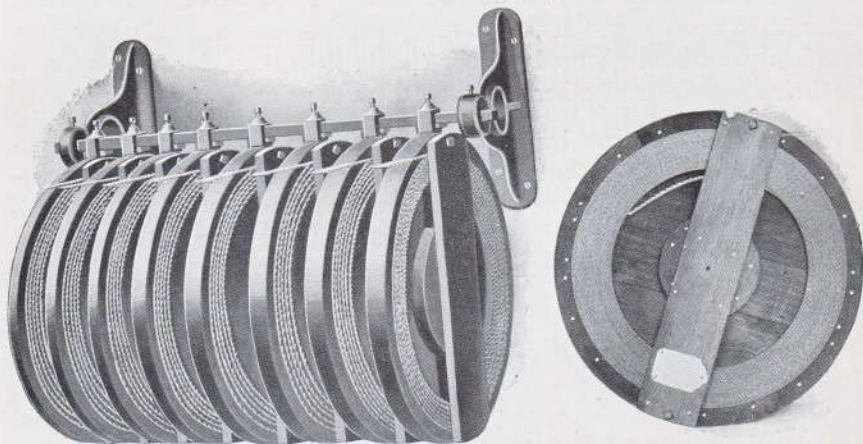

Simonds Narrow Band Saws are furnished either joined, or as separate saws, or in coils as shown above, 250 feet to a coil.

Our aim is always to have high quality saws.

We have originated a Rig for carrying Narrow Band Saws in stock.

The Rig is furnished free with an order for 2,000 or more feet of Narrow Band Saws, assorted in such sizes as may be your best sellers. A well assorted stock for the Rig would cover saws from $\frac{3}{8}$ to 1 inch wide.

The saw revolves only when projecting piece is pulled out from its board. By using this Rig, a larger assortment in gauges and widths can be carried, and less space be taken. The Rig will often save enough odd inches per coil to make an extra saw.

Points or Teeth?

The illustration herewith shows clearly the difference between "points per inch" and "teeth per inch." When ordering Narrow Band Saws always specify the number of teeth per inch.

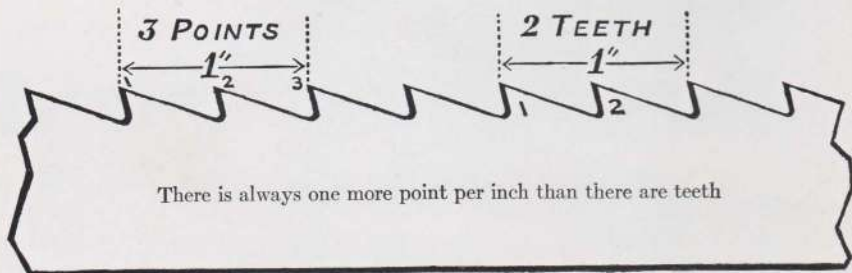

Simonds Narrow Band Saws



SPECIAL NOTICE.—Narrow Band Saws are furnished *Set* and *Filed*, but not *Brazed*.

SIMONDS STANDARDS

Heavy figures show saws, which the majority of the trade specify in the various sizes, on which prompt shipment is made.

Width, Inches	Price per Foot	Gauge	Teeth per Inch	Gauge	Teeth per Inch	Gauge	Teeth per Inch
$\frac{1}{8}$	\$0.13	23	6				
$\frac{3}{16}$.13	22	6				
$\frac{1}{4}$.13	21	5	21	4		
$\frac{3}{8}$.14	21	4	21	5		
$\frac{1}{2}$.15	21	4	21	3		
$\frac{5}{8}$.16	21	3	21	4		
$\frac{3}{4}$.18	21	3	20	3		
$\frac{7}{8}$.20	20	2$\frac{1}{2}$	20	3		
1	.22	20	3	20	2	20	2 $\frac{1}{2}$
$1\frac{1}{8}$.24	20	2				
$1\frac{1}{4}$.26	20	2	20	3		
$1\frac{3}{8}$.28	20	2				
$1\frac{1}{2}$.32	20	2	20	3		
$1\frac{3}{4}$.38	20	2				

Above prices cover Saws Set and Filed but not Brazed.

If not Filed and Set, deduct 4 cents per foot.

Brazing— $\frac{1}{4}$ to $\frac{1}{2}$ in., 50 cents each; $\frac{5}{8}$ to $\frac{7}{8}$ in., 60 cents; 1 to $1\frac{1}{4}$ in., 70 cents; $1\frac{3}{8}$ to $1\frac{3}{4}$ in., 80 cents.

Write for Discounts

Wide Band Saws

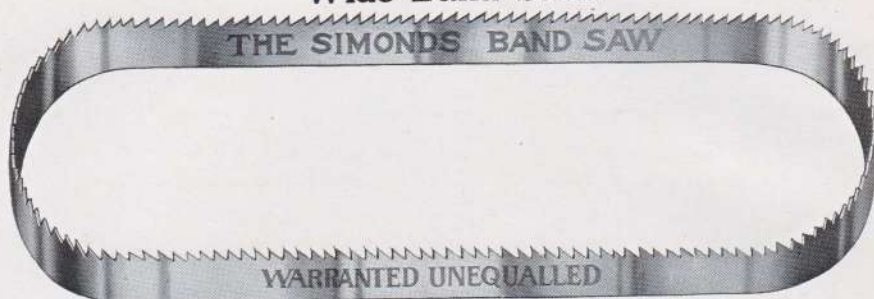

BRAZED AND FITTED

Width	Usual Gauge	Price per Foot
2 inch	18 to 20	\$1.00
2½ "	18 to 20	1.20
3 "	18 to 20	1.40
3½ "	18 to 20	1.60
4 "	17 to 19	2.00
4½ "	17 to 19	2.20
5 "	17 to 19	2.40
5½ "	17 to 19	2.70
6 "	17 to 19	3.00
7 "	16 to 18	3.40
8 "	14 to 16	3.80
9 "	14 to 16	4.30
10 "	14 to 16	4.80
11 "	14 to 16	5.40
12 "	13 to 15	6.00
13 "	13 to 15	7.20
14 "	13 to 15	8.40
15 "	12 to 14	10.20
16 "	12 to 14	12.00
17 "	12 to 14	16.80
18 "	12 to 14	21.60

Saws of odd widths, not listed, take price of next wider size listed.

For saws of heavier gauge than listed add 5 per cent to list for each gauge heavier.

No extra charge for saws one or two gauges thinner than list; when more than two gauges thinner, add 5 per cent to list for each gauge.

Double Edge Band Saws. List price per foot, all widths, advance 10 per cent over list prices of single edge saws as above.

Toothed Blanks. Same price as finished saws.

Band Saw Blanks. Bright, of any width, furnished to order, but not warranted.

Write for Discounts

Styles of Teeth in Wide Band Saws

On the three following pages are shown our standard shapes of teeth for Wide Band Saws, and the table below shows the die numbers which we use for saws of different widths and gauges.

Width	Gauge	Distance from Point to Point of Teeth.										
		5/8, 3/4, 7/8	1 in.	1 1/4 in.	1 1/2 in.	1 3/4 in.	2 in.	2 1/4 in.	2 1/2 in.	2 3/4 in.	3 in.	3 1/2 in.
2	18-21	2	*13 or 16	*13 or 16	†15
2 1/2	18-21	2	*13 or 16	*13 or 16	†15
3	18-21	2	*13 or 16	*13 or 16	†15
3 1/2	18-21	2	*13 or 16	*13 or 16	†15
4	17-21	*13 or 16	†15	15
4 1/2	17-21	*13 or 16	†15	15
5	17-21	*13 or 16	†15	15
5 1/2	17-21	*13 or 16	†15	15
6	17-21	*13 or 16	†15	15
6	17-18	16	15	15
7	17-18	16	15	15
7	16	15	48	47
8	15	48	49
8	16	48	47
9	17-18	47	47
9	14-15	48	49	50	50
9	16-17	48	47
10	14-15	48	49	50	50
10	16-17	48	47
11	14-15	48	49	50	50
11	16	48	47
12	13-14	48	49	50	50	55
12	15-16	48	49
13	12-14	48	49	50	50	55
14	12-14	48	49	50	50	55
15	12-13	50	50	55	57	61	60
16	12-13	50	50	55	57	61	60
17	12-13	50	50	55	57	61	60
18	12-13	50	50	55	57	61	60

*Die No. 13 is for Spring Set and Die No. 16 is for Swage Set.

†All re-saws 1 1/2 inch space, 6 inch wide or less, 19 gauge and thinner are made with die number 45 instead of die No. 15.

Simonds Band Saws

The illustrations herewith show spacing and depth of teeth, also patterns or die numbers commonly used. When ordering please refer to style tooth wanted.

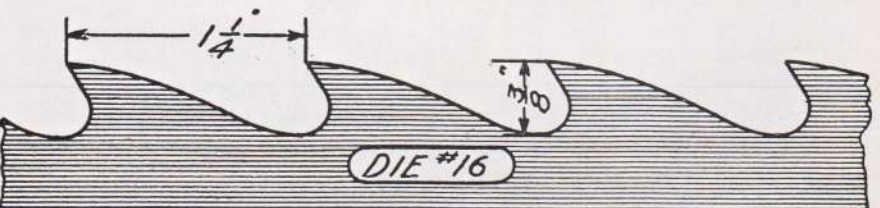
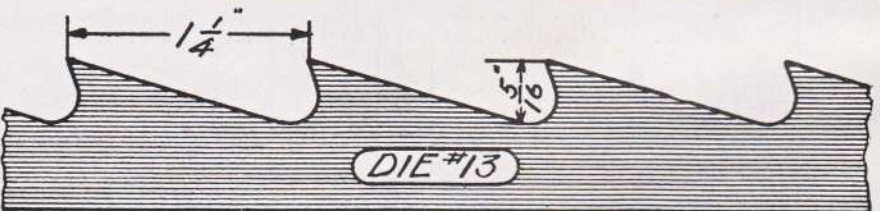
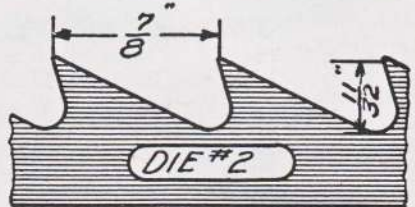
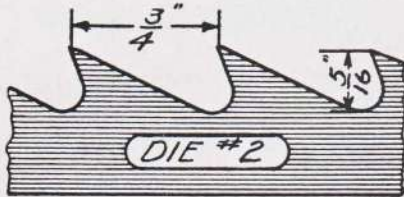
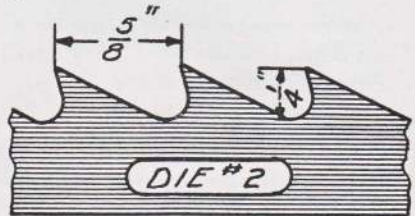
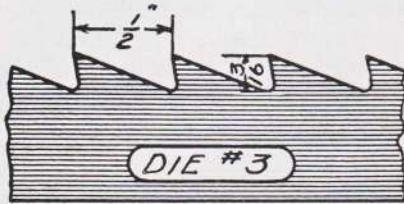

Simonds Band Saws

The illustrations herewith show spacing and depth of teeth, also patterns or die numbers commonly used. When ordering please refer to style tooth wanted.

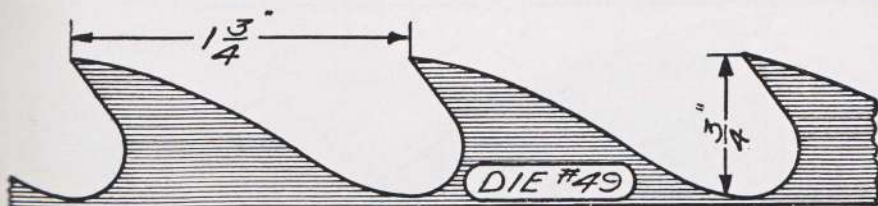
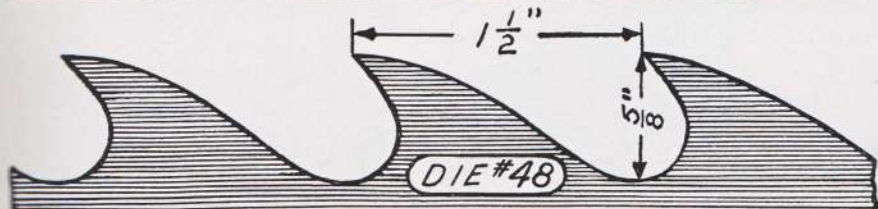
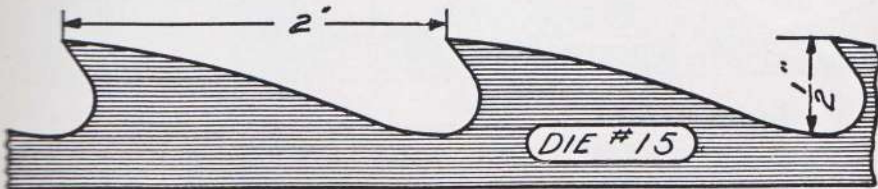
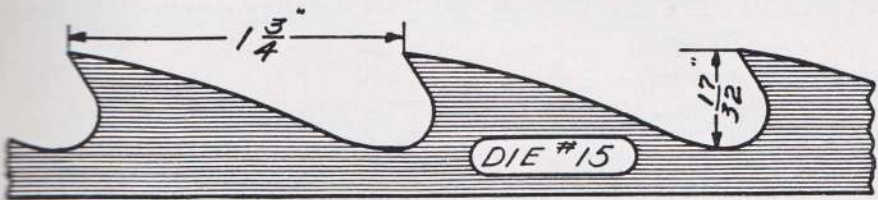
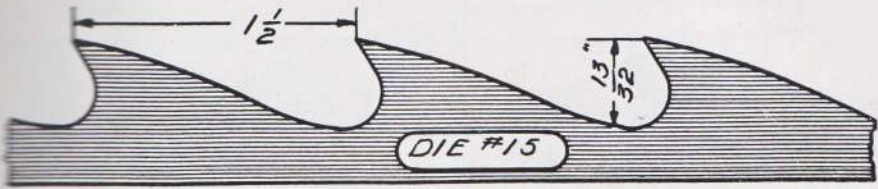

Simonds Band Saws

The illustrations herewith show spacing and depth of teeth, also patterns or die numbers commonly used. When ordering please refer to style tooth wanted.

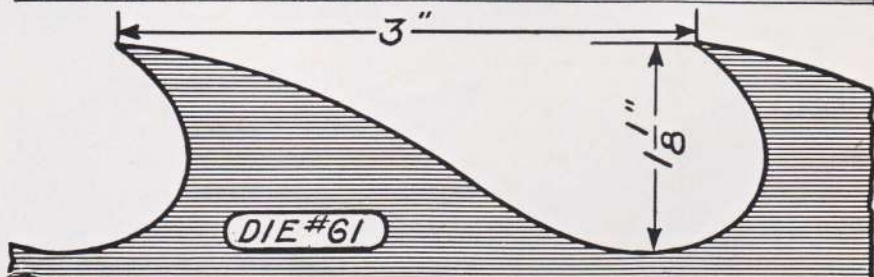
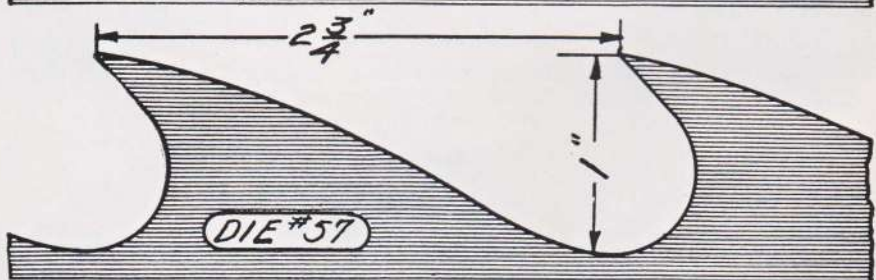
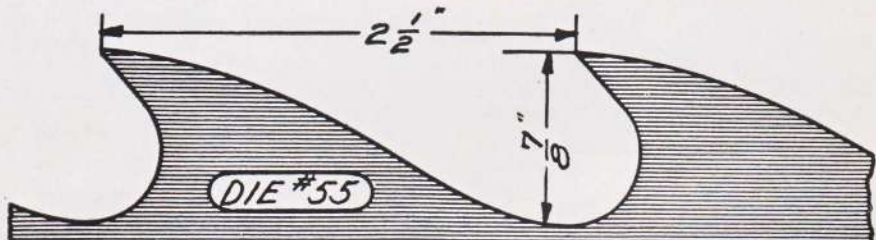
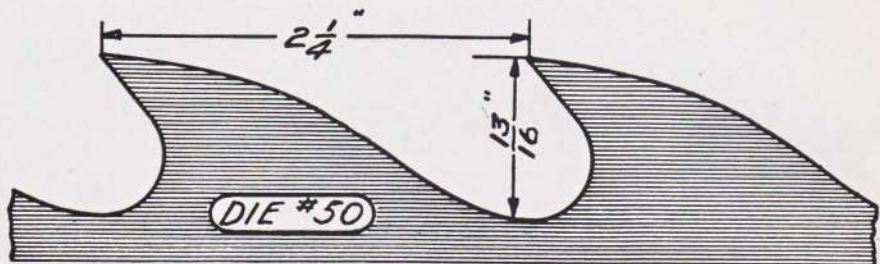
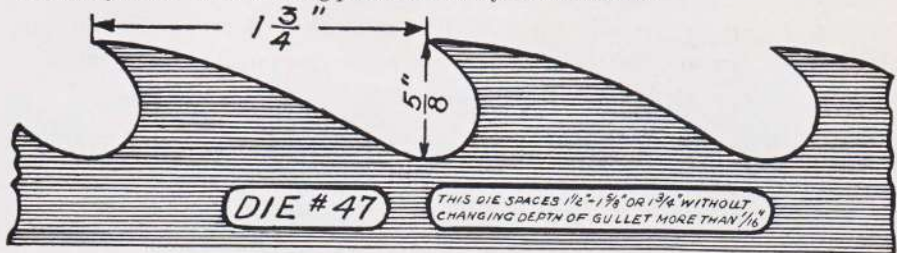

Simonds Gang Saws

The illustrations herewith show spacing and depth of teeth, also patterns or die numbers commonly used. When ordering please refer to style tooth wanted.

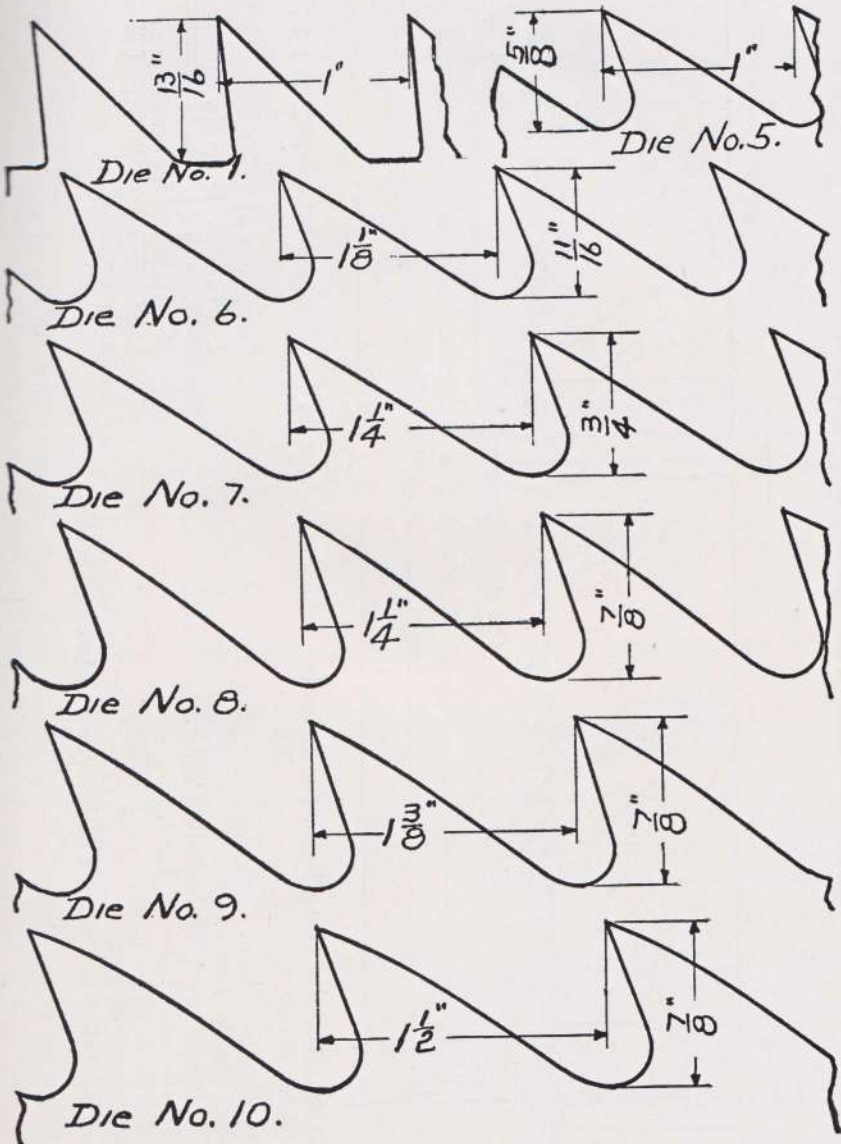

Instructions for Ordering Simonds Gang Saws

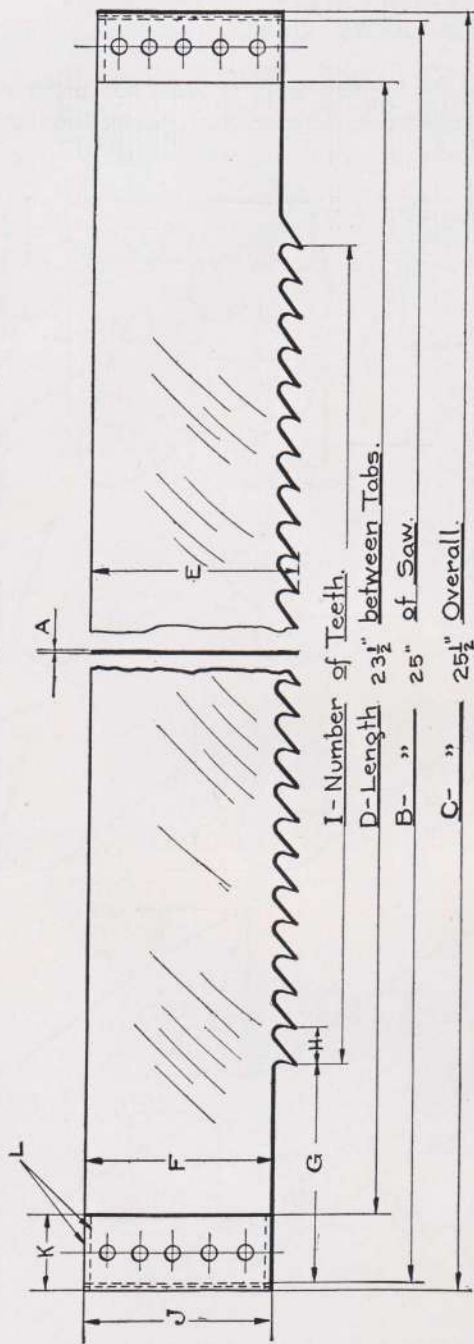

When ordering Gang Saws the following information should be given as completely as possible (letters refer to sketch above):

- A—Gauge of Saw.
- B—Length of Saw.
- C—Length over all, including Tabs.
- D—Distance between Tabs.
- E—Width of Saw.
- F—Width at Ends.
- G—Distance bottom end of Saw to point of first tooth.

- H—Space of Teeth.
- I—Number of Teeth.
- J—Length of Tabs.
- K—Width of Tabs.
- L—Location of Tabs. (Flush with back or equally divided?)

We want every Simonds Gang Saw to work perfectly and when we are given definite specifications by which to manufacture them they are covered by the broadest Simonds warranty.

Gang Saws

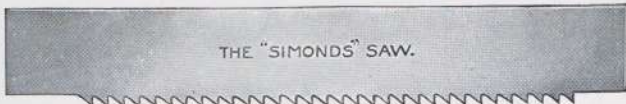

PRICE PER FOOT						
Width Inches	11 Gauge	12 Gauge	13 Gauge	14 Gauge	15 Gauge	16 Gauge
4	\$1.90	\$1.85	\$1.75	\$1.70
5	2.00	1.95	1.85	1.80
6	2.15	2.05	2.00	1.95
7	2.35	2.25	2.15	2.15
8	\$2.90	\$2.75	2.55	2.45	2.35	2.35
9	3.15	2.95	2.80	2.65	2.55
10	3.40	3.20	3.05	2.90	2.75

Above prices cover saws fitted, ready for use.

Gang Saws with reversed teeth, add 10 per cent to list prices.

For heavier gauges than listed above, use list on Mill, Muly, and Drag Saws.

Saws furnished without tabs, but with holes punched, add 2 cents net per hole.

Tabbing Gang Saws sold with bent tabs or two plate tabs.

4 hole	\$1.00
5 "	1.25
6 "	1.50
Round	1.25

Butting or Drag Saws, Tapered

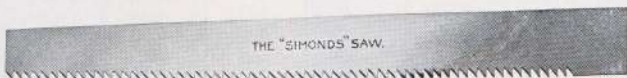

PRICE PER FOOT			
Width	Thickness		
	10 Gauge	11 Gauge	12 Gauge
Tapered 6 in. butt, 4 in. point	\$2.00	\$1.80	\$1.60
" 7 " " 5 " "	2.20	2.00	1.80
" 8 " " 6 " "	2.40	2.20	2.00

All saws fitted, ready for use.

Tapered Drag Saws wider or thicker than above will be figured by the Mill, Muly, and Drag Saw list, using the average width as the basis.

Drag Saws taper ground, add 5 per cent to the list for each gauge taper grinding.

Write for Discounts

Mill, Mulay, and Drag Saws



MILL SAW

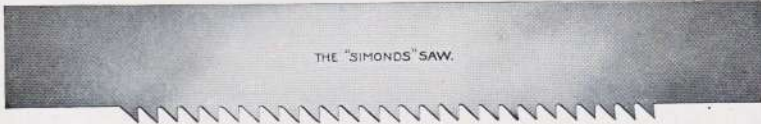

MULAY SAW



LANCE TOOTH DRAG SAW

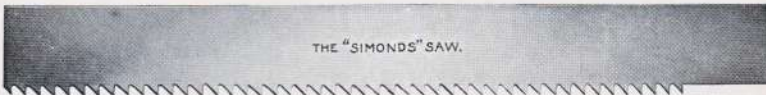

DRAG SAW OF EQUAL WIDTH

LIST PRICES PER FOOT FOR ABOVE SAWS

Width	4 Gauge	5 Gauge	6 Gauge	7 Gauge	8 Gauge	9 Gauge	10 Gauge
8 inch	\$6.00	\$5.60	\$5.00	\$4.40	\$4.00	\$3.60	\$3.40
9 "	6.40	6.00	5.40	4.80	4.40	4.00	3.60
10 "	7.00	6.40	5.80	5.20	4.80	4.40	4.00
11 "	7.60	7.00	6.40	5.80	5.40	4.80	4.40
12 "	8.40	7.80	7.00	6.40	6.00	5.40	4.80
14 "	9.60	9.00	8.20	7.60	7.00	6.40	5.80
16 "	11.20	10.60	9.60	8.80	8.20	7.60	7.00

All saws fitted, ready for use.

Above prices are for saws with Plain, Mill, Champion, or Lance tooth. Saws with special teeth, special prices. Mill, Mulay, or Drag Saws taper ground, add 5 per cent to list for each gauge taper grinding.

When ordering Mill, Mulay, or Drag Saws give length, width, thickness by gauge, style of teeth, space from point to point of teeth, and distance from end of saw to point of first tooth. If saws are to be drilled, send full size pattern, showing position of holes.

Write for Discounts

Simonds Pit Saw



Length . . .	5 ft.	6 1/2 ft.	7 ft.	7 1/2 ft.	8 ft.
Width . . .	3 1/4 x 10	3 1/2 x 10 1/2	3 1/2 x 11	3 1/2 x 11 1/4	3 1/2 x 11 1/2
Price, each	\$8.00	\$9.60	\$11.20	\$12.00	\$12.80

Above saws set and filed

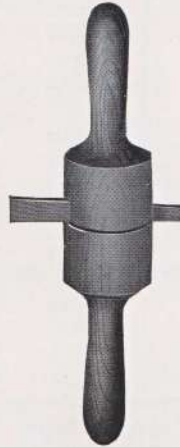

BOX FOR PIT SAWS, \$1.60 each



TILLER, \$2.00 each

Simonds Whip Saw



Length	5 ft.	5 1/2 ft.	6 ft.	6 1/2 ft.	7 ft.	7 1/2 ft.
Width	1 1/2 x 4	1 3/4 x 4 1/4	1 7/8 x 4 1/2	2 x 4 3/4	2 x 5	2 x 5 1/4
Price, each	\$4.80	\$5.40	\$5.80	\$6.40	\$6.80	\$7.20

Above saws set and filed

Write for Discounts

No. 190. Turning or Chair Webs

Set and Sharpened Ready for Use

SIMONDS MFG. CO.

6 inches	23 gauge	\$2.40 per dozen	$\frac{3}{16}$	to $\frac{1}{4}$ inch wide
7 "	22 "	2.50 "	$\frac{3}{16}$	" $\frac{1}{4}$ "
8 "	22 "	2.60 "	$\frac{3}{16}$	" $\frac{1}{4}$ "
10 "	22 "	2.80 "	$\frac{3}{16}$	" $\frac{1}{4}$ "
12 "	21 "	3.00 "	$\frac{3}{16}$	" $\frac{1}{6}$ "
14 "	21 "	3.20 "	$\frac{3}{16}$	" $\frac{5}{16}$ "
16 "	20 "	3.60 "	$\frac{1}{4}$	" $\frac{3}{8}$ "
18 "	20 "	4.00 "	$\frac{1}{4}$	" $\frac{1}{2}$ "
20 "	20 "	4.50 "	$\frac{1}{4}$	" $\frac{5}{8}$ "
22 "	20 "	5.00 "	$\frac{1}{4}$	" $\frac{5}{8}$ "
24 "	19 "	5.60 "	$\frac{1}{4}$	" $\frac{3}{4}$ "
26 "	19 "	6.20 "	$\frac{1}{4}$	" $\frac{3}{4}$ "
28 "	19 "	6.90 "	$\frac{1}{4}$	" $\frac{7}{8}$ "
30 "	19 "	7.60 "	$\frac{1}{4}$	" 1 "
32 "	18 "	8.40 "	$\frac{1}{4}$	" 1 "
34 "	18 "	9.20 "	$\frac{1}{4}$	" 1 "
36 "	18 "	10.00 "	$\frac{1}{4}$	" 1 "

One gauge heavier than above list, no extra charge.

When two gauges heavier than above list, felloe web prices will be charged. Extra width, 10 per cent additional for each $\frac{1}{8}$ inch.

No. 191. Felloe Webs

Set and Sharpened Ready for Use

6 inches	19 gauge	\$2.60 per dozen	$\frac{3}{16}$	to $\frac{1}{2}$ inch wide
7 "	19 "	2.80 "	$\frac{3}{16}$	" $\frac{1}{2}$ "
8 "	19 "	3.00 "	$\frac{3}{16}$	" $\frac{1}{2}$ "
10 "	18 "	3.40 "	$\frac{3}{16}$	" $\frac{1}{2}$ "
12 "	18 "	3.80 "	$\frac{1}{4}$	" $\frac{1}{2}$ "
14 "	17 "	4.20 "	$\frac{1}{4}$	" $\frac{1}{2}$ "
16 "	17 "	4.80 "	$\frac{1}{4}$	" $\frac{5}{8}$ "
18 "	17 "	5.40 "	$\frac{1}{4}$	" $\frac{5}{8}$ "
20 "	17 "	6.00 "	$\frac{1}{4}$	" $\frac{3}{4}$ "
22 "	17 "	6.60 "	$\frac{1}{4}$	" $\frac{3}{4}$ "
24 "	17 "	7.40 "	$\frac{1}{4}$	" $\frac{5}{8}$ "
26 "	17 "	8.20 "	$\frac{1}{4}$	" $\frac{7}{8}$ "
28 "	17 "	9.00 "	$\frac{1}{4}$	" 1 "
30 "	16 "	9.80 "	$\frac{1}{4}$	" 1 "
32 "	16 "	10.80 "	$\frac{1}{4}$	" 1 "
34 "	16 "	11.80 "	$\frac{1}{4}$	" 1 "
36 "	16 "	12.80 "	$\frac{1}{4}$	" 1 "

One gauge heavier than above list, no extra charge.

5 per cent extra for each additional gauge to 14 gauge; thicker than 14 gauge, special prices. Extra width, 10 per cent for each $\frac{1}{8}$ inch.

N. B. — All web saws, $\frac{1}{8}$ inch and narrower, will be made with wide ends, in order to give strength at the hole. Price, 25 per cent advance.

Write for Discounts

No. 194. Cabinet Pattern Webs



Length	Gauge	$\frac{3}{8}$ " to $\frac{3}{4}$ " wide Per Dozen	$\frac{7}{8}$ " to $1\frac{1}{8}$ " wide Per Dozen	$1\frac{1}{4}$ " to $1\frac{1}{2}$ " wide Per Dozen	$1\frac{5}{8}$ " to 2" wide Per Dozen
18 inches	23	\$4.20	\$4.80	\$5.20	\$5.80
20 "	23	4.40	5.00	5.40	6.00
22 "	23	4.60	5.20	5.60	6.40
24 "	23	4.80	5.40	5.80	6.80
26 "	23	5.10	5.80	6.20	7.20
28 "	23	5.40	6.20	6.60	7.60
30 "	23	5.80	6.60	7.20	8.20
32 "	22	6.20	7.00	7.80	8.80
34 "	22	6.60	7.40	8.40	9.40
36 "	22	7.00	7.80	9.00	10.00

No. 195. Extra Thin Back Cabinet Pattern Webs, ground two gauges thinner on back, add 80 cents per dozen to above list prices.

Above Webs are set and filed.

Five per cent advance for each gauge thicker than the above.

Five per cent advance for each gauge thinner than the above.

Twenty per cent advance for Webs toothed over 10 points per inch.

Twenty-five per cent advance for Webs toothed over 15 points per inch.

Webs thicker than 20 gauge, or thinner than 25 gauge, special price.

For Tanged Webs, add 80 cents per dozen to above lists.

Web Saws and Frames

No. 188

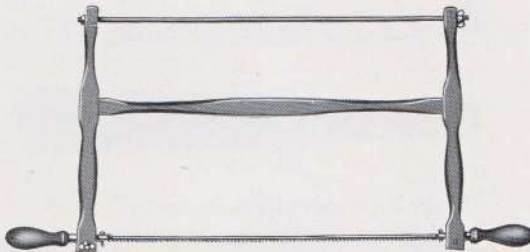

10, 12, 14, 16, 18, 20 inches \$16.15 per dozen
 22, 24, 26, 28, 30 inches , \$18.20 per dozen

Packed one-quarter dozen in box

Write for Discounts

No. 193. Fay Thin Back Scroll Saws

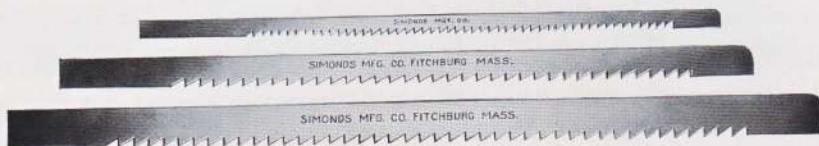

Inches	8	9	10	11	12	13
Per Dozen	\$3.60	\$4.00	\$4.40	\$4.80	\$5.20	\$5.60
Inches	14	16	18	20	22	24
Per Dozen	\$6.00	\$6.60	\$7.20	\$7.80	\$8.60	\$9.60

Webs to 16 inches, over $\frac{3}{4}$ inch wide, extra price. Webs from 18 to 24 inches, over one inch wide, extra price.

We make the above Webs from 13 to 16 gauge in thickness.

With pins, \$1.00 per dozen additional, list.

Swage Bar and Hammer



Swage Bars made with six or eight sides

Swage Bar No. 1, 11 × 1 × $\frac{1}{2}$ inch.....	each	\$7.00
“ “ “ 2, 11 × 1 $\frac{1}{4}$ × $\frac{5}{8}$ “	“	8.40
“ “ “ 3, 11 × 1 $\frac{1}{2}$ × $\frac{3}{4}$ “	“	9.70
“ “ “ 4, 11 × 1 $\frac{3}{4}$ × $\frac{5}{8}$ “	“	11.00
Hammers.....	“	2.75

Any size or shape of Swage Bar furnished at special price.

Saw Makers' Tools

Anvils, Hammers and Straight Edges

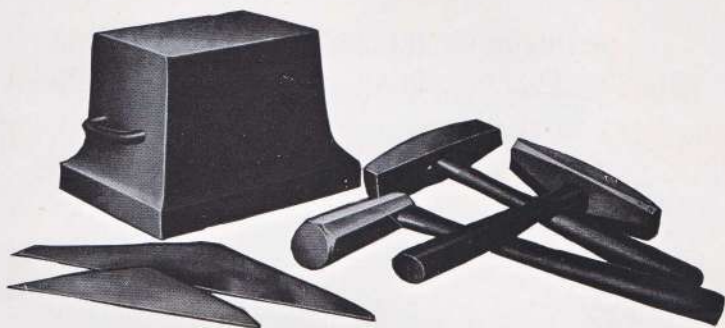

Circular and Band Saw Anvils	{ 180 lbs. and less { Over 180 lbs. . .	\$0.30 per lb.
Cast Steel Face, Hardened and Polished.		.35 per lb.
Saw Makers' Hammers		\$2.00 per lb.
No hammer at less than 2½ lbs.		
Straight Edges — Under 5 feet		\$2.00 per ft.
Over 5 feet, prices quoted on application.		

Band Saw Anvils. Chilled Face

Size	Approximate Weight	List Price
6 × 8 5 inches high	75 lbs.	
6 × 10 5 " "	85 " "	
8 × 8 5 " "	100 " "	
10 × 12 5 " "	160 " "	
10 × 14 5 " "	185 " "	
12 × 16 5 " "	270 " "	
14 × 24 5 " "	450 " "	

Band Saw Leveling Blocks (surfaced both sides)

Size	Approximate Weight	List Price
8 × 36 × 3	230 lbs.	
10 × 36 × 4	375 " "	
10 × 48 × 3	360 " "	
10 × 48 × 4	480 " "	
12 × 48 × 4	600 " "	
12 × 60 × 4	695 " "	
14 × 60 × 4	900 " "	

Write for Discounts

Swages or Upsets



No.3

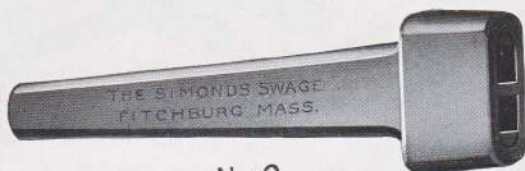

No.2



No.1

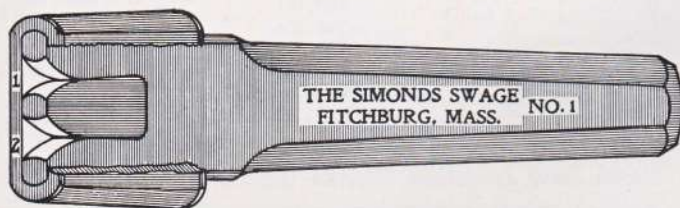

This sectional view shows the construction of the Simonds Swage. Jaw No. 1 spreads or shapes the point of the tooth. Jaw No. 2 squares up the cutting edge and gives body to the swaged point.

	Each	Net Weight
Simonds Swage, No. 1, for saws 10 gauge and heavier.....	\$5.50	18 ounces
“ “ No. 2, for saws 11 gauge and lighter.....	4.50	8 “
“ “ No. 3.....	3.50	3 “
“ “ (Special), for wide band saws.....	4.50	8 “

Write for Discounts

Hanchett Band Saw Swage

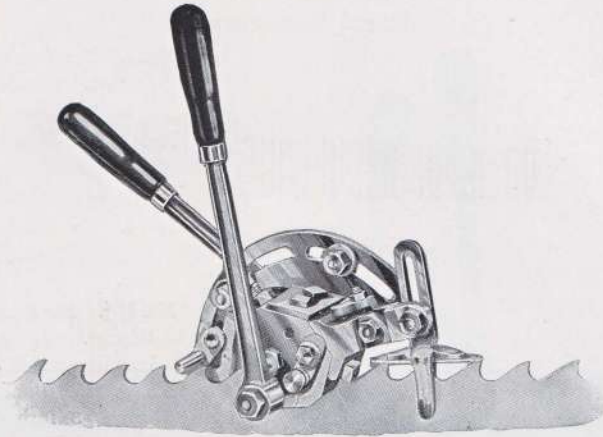

The Hanchett Band Saw Swages are especially adapted for band, band resaw, and gang saws, and have established a reputation for giving complete satisfaction at all times. They are unusually strong swages, and their construction is simple and compact.

- Size No. 0 for saws 8-13 gauge
- Size No. 1 for saws 12-16 gauge
- Size No. 2 for saws 16-18 gauge
- Size No. 3 for saws 18-26 gauge

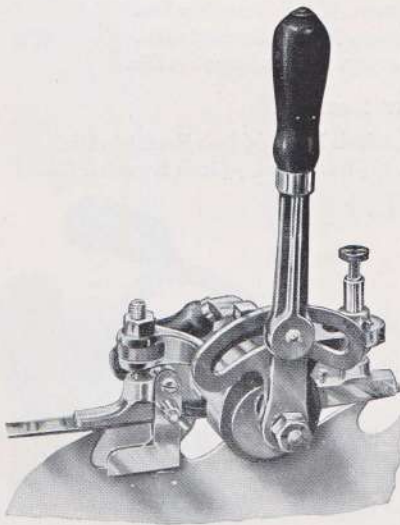

Hanchett Band Swage Shaper

- Size No. 1
For saws 10-13 gauge ..
- Size No. 2
For saws 12-18 gauge ..
- Size No. 3
For saws 16-22 gauge ..

Write for Prices

Armstrong Swages and Shapers

Band Saw Swages

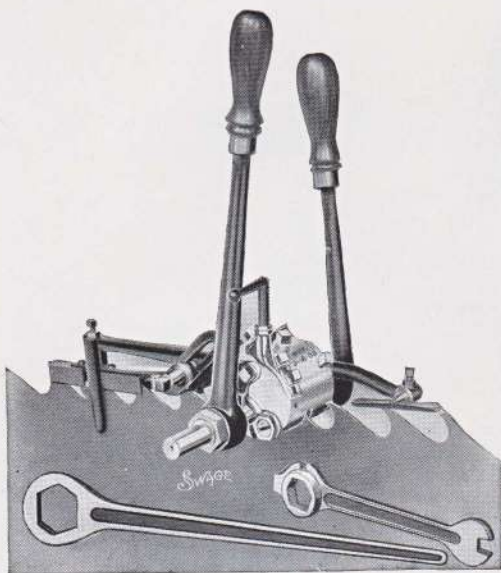

No. 1. For Resaws 19 gauge and thinner. 2 inch Head, $\frac{3}{8}$ inch Eccentric Die.

No. 2. For Resaws 17 gauge and thinner. $2\frac{1}{2}$ inch Head, $\frac{3}{8}$ inch Eccentric Die.

No. 4. For Bands 14 to 17 gauge. $2\frac{1}{2}$ inch Head, $\frac{1}{2}$ inch Eccentric Die.

No. 4 $\frac{1}{2}$. For Bands 14 gauge and thinner. $2\frac{1}{2}$ inch Head, $\frac{1}{16}$ inch Eccentric Die.

No. 5. For Bands 13, 14, or 15 gauge, 3 inch Head, $\frac{5}{8}$ inch Eccentric Die.

No. 6. For Bands, 13 or 14 gauge. 3 inch Head, $\frac{3}{4}$ inch Eccentric Die.

No. 7. For Bands 11, 12, or 13 gauge, $3\frac{1}{2}$ inch Head, $\frac{7}{8}$ inch Eccentric Die.

Circular Saw Swages

No. 8. For Shingle Saws 16 to 17 gauge, $\frac{1}{2}$ inch Eccentric Die.

No. 8 $\frac{1}{2}$. For Shingle Saws 17 to 19 gauge, $\frac{3}{8}$ inch Eccentric Die.

No. 9. For Circular Saws 12 to 15 gauge, $\frac{5}{8}$ inch Eccentric Die.

No. 9 $\frac{1}{2}$. For Circular Saws 8 to 12 gauge, $\frac{3}{4}$ inch Eccentric Die.

No. 11. For Circular Saws 4 to 12 gauge, $\frac{3}{4}$ inch Eccentric Die.

No. 13. For Circular Saws 13 to 16 gauge, $\frac{1}{2}$ inch Eccentric Die.

Gang Saw Swages

No. 10. For Gangs 13 to 16 gauge, 3 inch Head, $\frac{5}{8}$ inch Eccentric Die.

No. 12. For Gangs 15 to 20 gauge, $2\frac{1}{2}$ inch Head, $\frac{1}{2}$ inch Eccentric Die.

Shapers

No. 1. For Bands 16 to 19 gauge.

No. 2. For Bands 14 to 17 gauge.

No. 3. For Bands 11 to 14 gauge.

No. 4. For Circulars 4 to 12 gauge.

No. 5. For Circulars 13 gauge and thinner.

A catalogue of Armstrong saw fitting tools sent on application.



Write for Prices

Simonds Adjustable Saw Sets

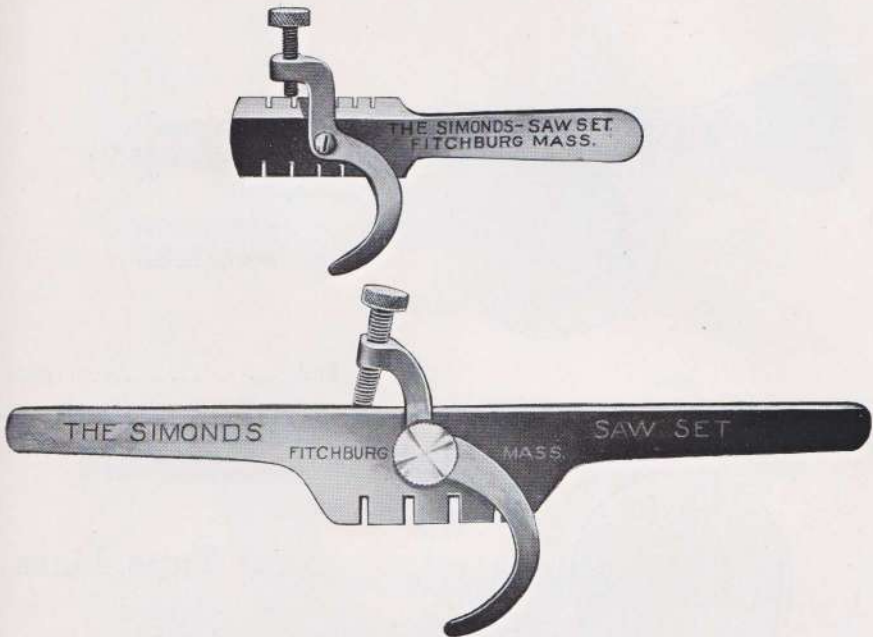

Made in three sizes and provided with an adjustable gauge, which regulates the set and gives absolute uniformity

- No. 301.** Saw Set with one handle, for small circulars and band saws will take saws 14 to 19 gauge in thickness \$4.25 each
- No. 302.** Saw Set, for medium and large circulars. Will take saws 9-10-11-12 gauge in thickness. \$6.50 each

Saw Sets



- No. 303.** Saw Set, with one handle. Will take saws 14 to 17 gauge in thickness. \$2.25
- No. 304.** Saw Set, with two handles. Will take saws 7-9-11-13-15 gauge in thickness. \$3.25

Write for Discounts

Speed Indicators

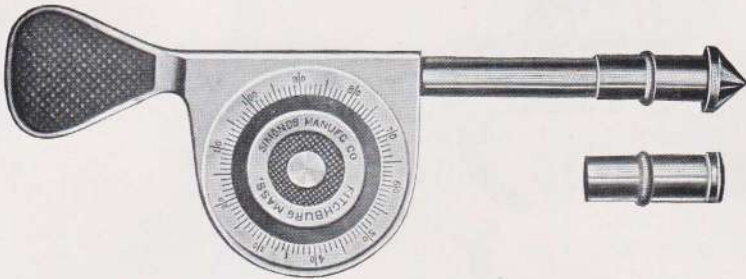

Each..... \$2.00



Steel Tape Lines

3 foot long
5 foot long



Steel Scales

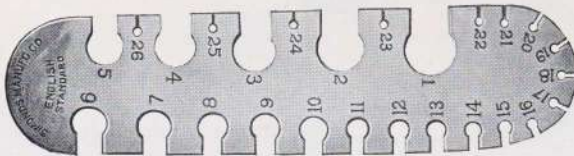

Saw Gauges

Each..... \$2.00

See Discount Sheet for Prices

Self-Oiling Saw Arbors

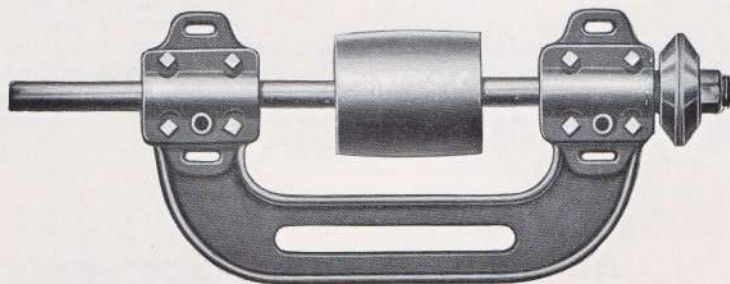

The above cuts represent an Improved Pattern of Saw Arbors with SELF-OILING BOXES. The bed and boxes are cast together, and are consequently always in line. All end motion is prevented by a number of V-shaped grooves on one of the journals, with corresponding rings in the Babbitt lining of the box. The shafts are made of steel, and in every respect are fitted up in the best possible manner.

No.	Size of Saw Inches	Distance from Pulley to Saw Inches	Diameter of Pulley, Inches	Face of Pulley Inches	Diameter of Collar, Inches	Diameter of Arbor, Inches	Hole in Saw Inches	PRICE	
								Plain Collar	
1	10	18	4	4 $\frac{1}{2}$	3	1 $\frac{1}{8}$	$\frac{1}{8}$	\$16.00	
2	14	21	4 $\frac{1}{2}$	5	3 $\frac{1}{2}$	1 $\frac{1}{8}$	$\frac{1}{8}$	18.00	
3	18	24	5	5	4	1 $\frac{1}{4}$	$\frac{1}{8}$	20.00	
4	24	26	6	6 $\frac{1}{2}$	4 $\frac{1}{2}$	1 $\frac{3}{8}$	1 $\frac{1}{8}$	25.00	
5	28	28	7	7	5	1 $\frac{1}{2}$	1 $\frac{1}{8}$	30.00	
6	36	30	8	8	5 $\frac{1}{2}$	1 $\frac{3}{4}$	1 $\frac{1}{2}$	35.00	

The above six sizes carried in stock of both straight and yoke frame patterns. Special Arbors can be furnished in any form and size, with connected boxes, bed boxes or pivot boxes, as desired, with either plain collars or improved taper bushing for centering saws with different size of holes.

Setting Machine for Band Saws

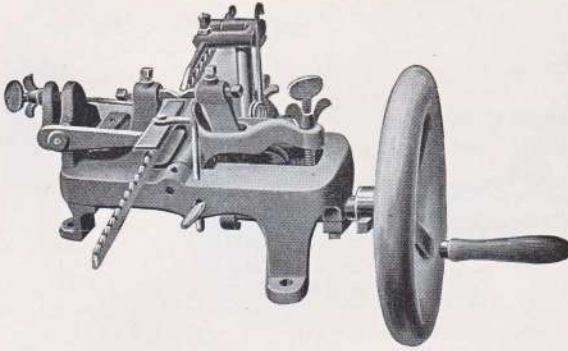

The regulating, which is necessary for other Setting Machines, is done away with by the simplicity of this machine.

The teeth are set absolutely uniform, which necessitates and guarantees a clean cut.

Saws from $\frac{1}{8}$ inch to $1\frac{1}{2}$ inches in width can be set without bending the smaller Saws, as the vise grasps the Saw perfectly tight, setting the teeth during the movement; all

Saws which have been bent before, being straightened out at the same time.

Saws set with this machine do not crack at the edges of the teeth, as the points only of the teeth are set, and not the entire tooth as with other machines.

The machine is built on strong principles, and all working parts are manufactured of tempered steel, thus making wearing out impossible.

A Saw 20 feet in length can be set in three minutes with this machine.

Price, \$26.40

Automatic Filing Machine

For Band Saws

So simple is this machine that it takes but a few minutes to regulate it and adjust the Saw, and it also needs no attention after once being started.

By means of a joint, sufficient time is given the file to get properly located in the tooth of the Saw before the filing operation begins.

This machine is the result of many years' practical experience. The main point is the movement through which the file falls into the tooth of the Saw, this imitating exactly the movement of the human hand.

The file works by the pressure of a spring, and comes down in the tooth in a bevel line, receding the same way after the file stroke, filing out equally both top and bottom of tooth and not injuring the point in any way.

By filing with this machine, the teeth of the Saw keep a proportionate height, every single tooth coming to the cut, thus keeping the Saw sharp longer.

Any ordinary saw file can be used with this filing machine, no extra straight-shaped files being necessary.

Saws from $\frac{1}{8}$ to $1\frac{1}{2}$ inches wide, and any length, can be filed at the rate of ninety teeth per minute.

Old Saws are filed as well as new ones, no matter how uneven the teeth.

Price, \$50.00

Write for Discounts

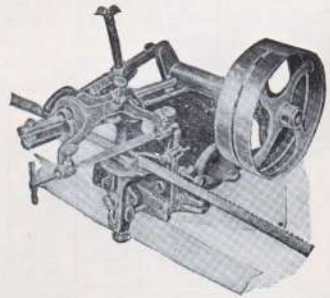

Scroll Band Saw Guide

Quality and Efficiency the Very Highest.

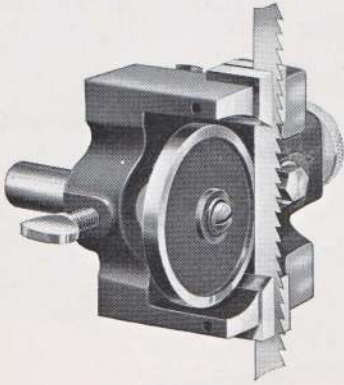

In the case of this saw guide the back of the saw runs against the face of a tempered tool steel disk, ground true and smooth, preventing the heating and crystallization of the blade and the consequent tendency to cracking or breaking of saws from this cause.

The disk spindle has a long, accurately fitted bearing socket, is self oiling, and requires attention say once a month. The oiling is accomplished by means of the machine screw plug in front end of the disk spindle.

The end of the disk spindle bears against a hardened steel ball and the pressure on back of saw is regulated by a spiral spring.

If the band saw construction requires a very short guide, the spiral spring may be omitted, the ball alone affording the same frictionless thrust. The omission of the spring from the smaller guides in no way impairs the efficiency

because of the light pressure exerted by narrow saws.

The side guides or jaws are of tool steel, hardened and polished, and practically frictionless, interchangeable, that is, either R. H. or L. H., and all sizes of guides are equipped with knurled screw adjustment for opening the jaws.

No. 0	$\frac{1}{8}$ to $1\frac{1}{4}$ inch.....	List Price \$10.00
No. 1	$\frac{1}{8}$ to $1\frac{1}{2}$ inch.....	List Price 12.50
No. 2	$\frac{1}{4}$ to $2\frac{1}{2}$ inch.....	List Price 15.00

In ordering No. 0 Guides, be sure to specify whether for use above or below the table. We supply a shorter Socket when wanted for use below the table.

Guides can be Applied to all Scroll Band Sawing Machines

Improved Saw Filing Clamp

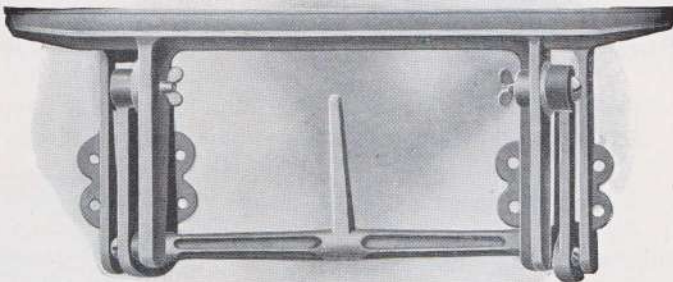

The above cut represents the latest Improved Saw Filing Clamp. It is especially adapted for filing Band, Hand, and any other saws, from $\frac{3}{16}$ to 7 inches in width. The jaws being 23 inches long, allow a large section of the saw to be held in position for filing, thus saving a large percentage of time in sharpening saws. Price, each, \$7.50.

Write for Discounts

Band Saw Brazing Clamp and Tongs

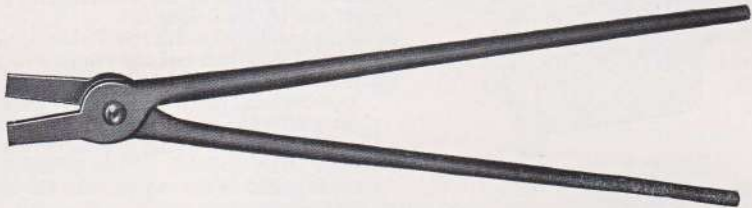

Clamps..... Price, \$5.00 each
 Tongs..... Price, \$1.50 each

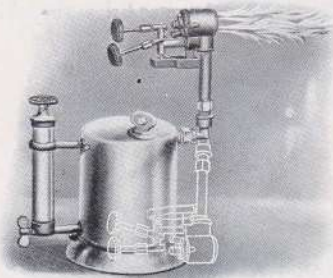

Brazing Lamp

Produces an intensely hot pointed flame. An excellent lamp for brazing and for all ordinary work for which a common blow torch is used.

Price, each \$11.40

Simonds Silver Solder

For Brazing Band Saws

A good flowing and strong solder.

Made in the following widths : $\frac{1}{2}$, $\frac{5}{8}$, $\frac{3}{4}$, $\frac{7}{8}$, and 1 inch.

Thickness: .002, .003, .004 inch.

Put up in one-ounce pasteboard or brass boxes.

Price.....\$1.00 per ounce



Write for Discounts

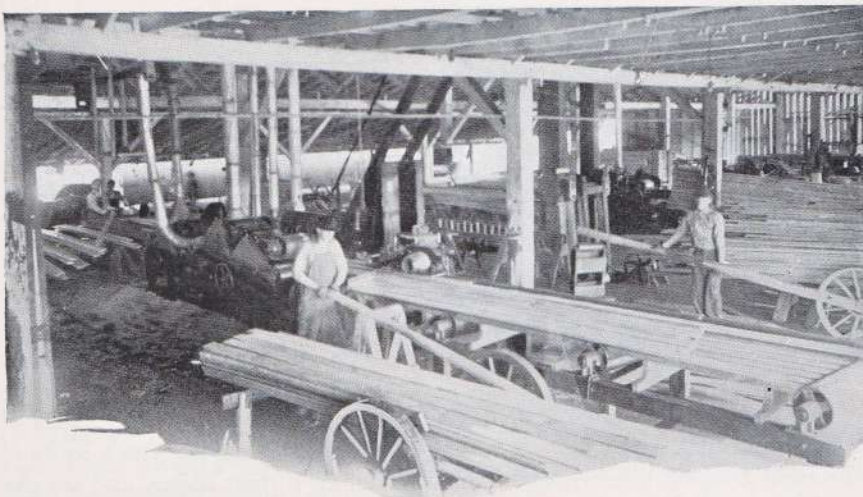

Simonds Machine Knives

We make any kind of a knife for any kind of a machine for any kind of work, and will guarantee the very best possible results relative to temper, uniformity, cutting qualities, finish, and length of service.

When Ordering Knives

State number of knives wanted, number of sets, number in set, length, width, thickness, name and make of machine, and kind of wood to cut.

The cutting edge always constitutes the length of the knife.

When possible, furnish a pattern. Place the knife face down on the paper, mark around to show the length of the knife and size and position of slots, and be sure to state the width and thickness, as shown in diagram; also state the number of knives in set, and the temper required, whether high, to grind only, medium, to file slowly, or low, to file easily.

We make a wooden pattern like each paper pattern sent us, stamp the same with name of party ordering and date the order is received, and preserve for future use.

It is well to send an old knife or a pattern showing the holes or the slots. This is particularly true in ordering Planer Knives, Paper Knives, Barker and Chipper Knives, etc.

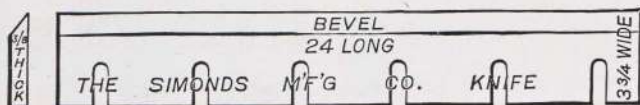

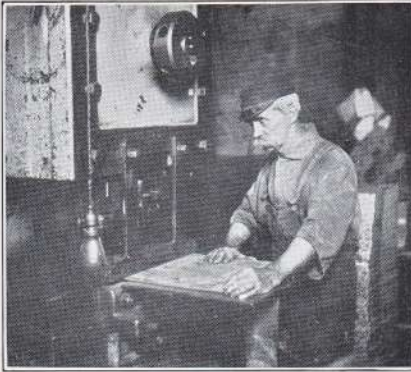

Tempering

Our furnaces are all controlled by pyrometers, which register the exact heat; and if we know the wood which you are to plane, it is an easy matter for us to decide what temper to leave the knife and what degree of heat to use in order to get the exact temper for the work which is to be done. It is well to specify the kind of wood which you wish to plane and the feed per minute.

Our method is such that we keep an accurate record of the temper of every knife that we make. If we have succeeded in giving you a knife of the right temper, when ordering again refer to former order, and we can duplicate the temper and quality as previously furnished.

The varieties of temper adapted for Planer Knives, Paper Knives, Veneer Cutting Knives, Leather Knives, Tobacco Knives, Hog Knives, as well as other knives are most carefully selected. At the same time, much attention is given to the balancing, grinding, finishing, and packing of all knives, and an absolute guaranty is given that the knives furnished will prove entirely satisfactory. We are specialists in knife making, having made knives since 1832, and we would like to take up with you any question at all regarding the making of knives to fit your special work. Write us regarding any troubles which you may have had. Tell us what they are and we will endeavor to overcome them.

In knives, as well as in all other edged tools, good steel is the fundamental part, without which it is impossible to get a satisfactory cutting edge. The Simonds Steel used in the Simonds Knives is a special crucible knife steel, made by ourselves in our own steel mill.

Simonds High Speed Steel Knives

The material used in the manufacture of High Speed Steel Knives is the same steel which turns off steel chips red hot from huge shafts or forgings in our navy yards and machine shops. It is called steel but is really an alloy of tungsten,

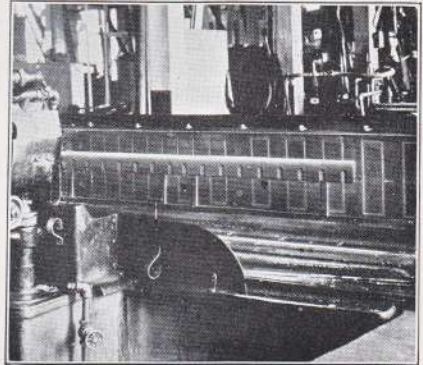

the same material as the incandescent filament of an electric light. With this tungsten is alloyed iron, chromium, vanadium, carbon and the other usual elements found in steel.

What makes high speed steel so good is the ability of tungsten, as shown in the incandescent light, to retain its strength and hardness even though it is heated to a red heat which would take all the temper out of the ordinary steel and leave the edge soft and worthless.

This property was called red-hardness by some man with common sense, and means just what it says. With properly hardened high speed steel you can heat the knife to a dull red heat and it will still continue to cut and when it cools down to normal temperature it will be as hard as it was before. The high speed steel used on knives must be of a very special analysis that will bring out the properties necessary for cutting wood. This has meant a lot of work by our steel mill, our factory and our customers in trying out new ideas so that the Simonds High Speed Steel would be always in the lead as their saw steels are in other fields.

Having obtained the best material by actual testing, the methods used in the factory are maintained at the highest level so that the quality of the knife will be of uniform excellence.

In making high speed knives only the most skilled men can be used as the hardening, tempering, grinding and straightening are operations which call for a high degree of knowledge and skill. The hardening consists of heating the knife to a temperature just under the melting point, taking care that it does not get out of shape under this heat then cooling the white hot knife in a quenching bath and next heating it to the proper degree for tempering. The temperature in these different operations must be very closely controlled. Our furnaces are all kept under close control by electric pyrometers, maximum variation allowed being 10 degrees Fahrenheit.

After hardening, knives must be ground on all sides and beveled on the cutting edge. This grinding must be done with care to prevent cracks starting from uneven expansion. Extreme care is given the knives in this operation in the factory.

The knives are accurately balanced, etched and shipped to the customer. Comparative tests under the same working conditions have proved conclusively that Simonds High Speed Steel Knives give the best satisfaction.

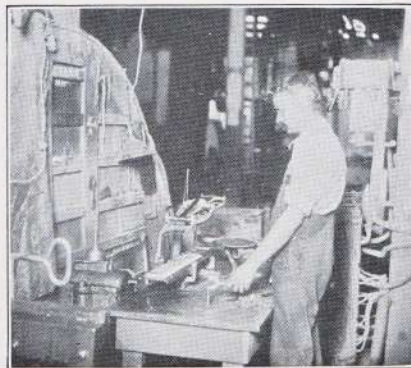

Simonds Welded High Speed Steel Knife



Of decided interest to the man who uses the old style carbon steel planer knives is this new Simonds achievement—the welding of High Speed Steel to a softer backing.

As you know, thick woodworking knives have the cutting edge welded on to a softer metal backing. Heretofore this cutting edge has been merely a higher grade steel.

The best steel for a cutting edge is what is known as High Speed Steel.

Up to the present it has been considered impossible to weld High Speed Steel to a soft metal backing.

Whenever this edge was placed on a knife it has been necessary to braze it on. This is all right when the knife doesn't need to be heated again to a high temperature for when this is done the braze just naturally melts apart.

A "Welded" knife, on the other hand isn't so affected when heated to a high temperature for, as you know, a weld is practically a fusing of the two metals into one whole.

Now why does a knife need to be heated?

Heating is the method by which a steel cutting edge is tempered.

Temper is necessary so that every spot along the knife edge will cut exactly the same—no hard and soft spots to mar your lumber.

Temper is necessary if the knife is to hold its cutting edge.

Holding the cutting edge means less grinding, less changing of knives, less wear on the knives, more production, better grade stock.

That's why the Simonds Welded High Speed Steel Thick Knives will last from three to five or more times longer than the ordinary Carbon Steel Thick Knives.

That is why you want a genuine Simonds "Welded" Knife and not the ordinary "Brazed" High Speed Steel Knife.

We are, so far as we know now, the only manufacturers who have solved, properly, this problem of "welding" High Speed Steel Cutting Edges to Machine Knives. Send your orders to our nearest branch office for at least a trial set of these knives. Send pattern and give full instructions as to length, width, thickness, number to set, beveled or square back, make of machine, whether for slotted or solid heads, etc.



Simonds Knives



Planer Knife



High Speed Steel Knife



Welded High Speed Steel Knife



Back Bevel Planer Knife



Chair Bottom Knife



Moulding Knife



Beveled Steel

Simonds Knives



Beader Bits



Straight Bit



Tongue and Groover Bit



Washboard Knife



Double Cut



Excelsior Knife



Straight Knife



Gauge Lathe Knife

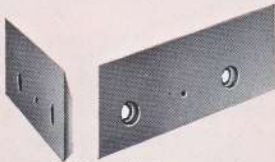

Mitre Knives



Cope Cutters



Untempered
Moulding
Blank

Simonds Knives



Chipper Knife

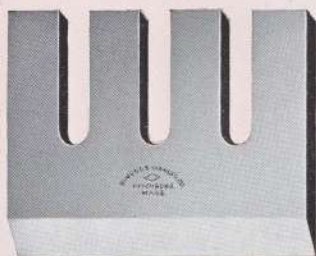

Hog Knife

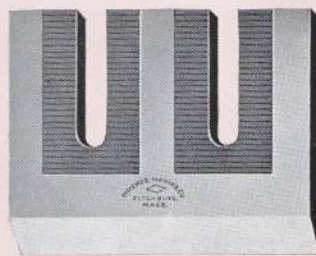

"Griptight" Hog Knife



Beveled End Chipper Knives
Made with one or more slots



Barker Knife



Barker Knife

Simonds Knives



Veneer Knife

When ordering Veneer Knives be sure to specify the bevel desired



Stave Knife



Jointer Knife



Shingle Knife



Stave Jointer Knife



Tight Barrel
Knife



Spoke
Knife



Slack Barrel
Knife



Jointer
Knife



Stop Cutter Knife



Paper Cutter Knife

Simonds Knives



Legg Tobacco Knife



Cigarette Cutter

Cigarette Belt

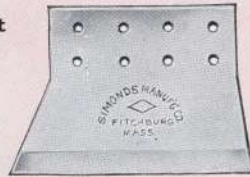

Foreign Tobacco Knife



Pease Tobacco Knife



Pease Tobacco Knife

Simonds Shears and Slicers



Tack Shears



Angle Shears



Scrap Iron Shear



Boiler Plate Shears



Vegetable Slicers

Simonds Knives



Union Leather Splitter Knife

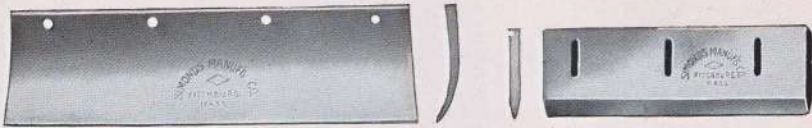

Curved Fur Bed Knife

Double Bevel
Leather Splitter Knife



Union Leather Splitter Knife



Belt Knife Guide



Rag Knife

Simonds Belt Knives



Simonds high grade belt knives are sold extensively throughout the world.

Made of special crucible steel.

Standard or regular width $3\frac{1}{4}$ inches. Special widths made to order.

Made for 57 inch, 72 inch, 84 inch, or 106 inch machines. When ordering give carefully length and width of belts or make and size of machine.

Belts can be supplied in any of the three following standards:

Regular or Mild Blades, Medium Blades,
Hard Blades.

When ordering, specify which kind of belt is required.

Packed neatly in crates or boxes holding from 1 to 24 each.

Prices quoted on application.

Simonds Circular Knives for Paper, Cork, Rubber, Cloth, and Leather



Diameter	List Price	Thickness
10 inches and less	\$0.57 per inch in diameter	$\frac{3}{32}$ inch
Over 10 to 12 inches	.65 " " " "	$\frac{1}{8}$ " "
" 12 " 14 "	.72 " " " "	$\frac{1}{8}$ " "
" 14 " 16 "	.80 " " " "	$\frac{1}{8}$ " "
" 16 " 18 "	.88 " " " "	$\frac{5}{32}$ " "
" 18 " 20 "	.95 " " " "	$\frac{3}{16}$ " "
" 20 " 22 "	1.04 " " " "	$\frac{5}{32}$ " "
" 22 " 24 "	1.12 " " " "	$\frac{3}{16}$ " "
" 24 " 26 "	1.20 " " " "	$\frac{3}{16}$ " "
" 26 " 28 "	1.27 " " " "	$\frac{3}{16}$ " "
" 28 " 30 "	1.35 " " " "	$\frac{3}{16}$ " "
" 30 " 32 "	1.51 " " " "	$\frac{3}{16}$ " "
" 32 " 34 "	1.68 " " " "	$\frac{1}{4}$ " "
" 34 " 36 "	1.90 " " " "	$\frac{1}{4}$ " "

For knives heavier than listed add 5 per cent for each $\frac{1}{64}$ inch heavier.

For equivalents of gauges in inches, see page 10.

When ordering give diameter, gauge, size of hole, whether beveled on both sides or only on one, and how deep bevel is to run.

Simonds Cane Knives



No. 483

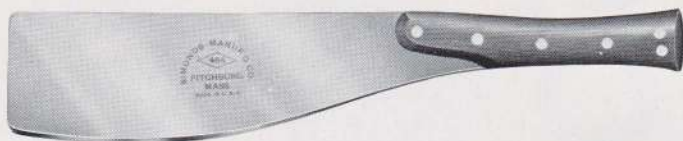

No. 484



No. 490



No. 491

Number	Length over all inches	Length of Blade inches	Width at Point inches	Thickness Gauge
483	21 $\frac{3}{4}$	14 $\frac{1}{2}$	4 $\frac{1}{8}$	18
484	21 $\frac{3}{4}$	12 $\frac{3}{8}$	4 $\frac{1}{8}$	18
490	21 $\frac{1}{4}$	14	4 $\frac{1}{2}$	18
491	20	11 $\frac{1}{4}$	5 $\frac{5}{8}$	19

Other patterns of Cane Knives not listed above can be furnished on special order.

Write for Prices

Simonds Steel Rule

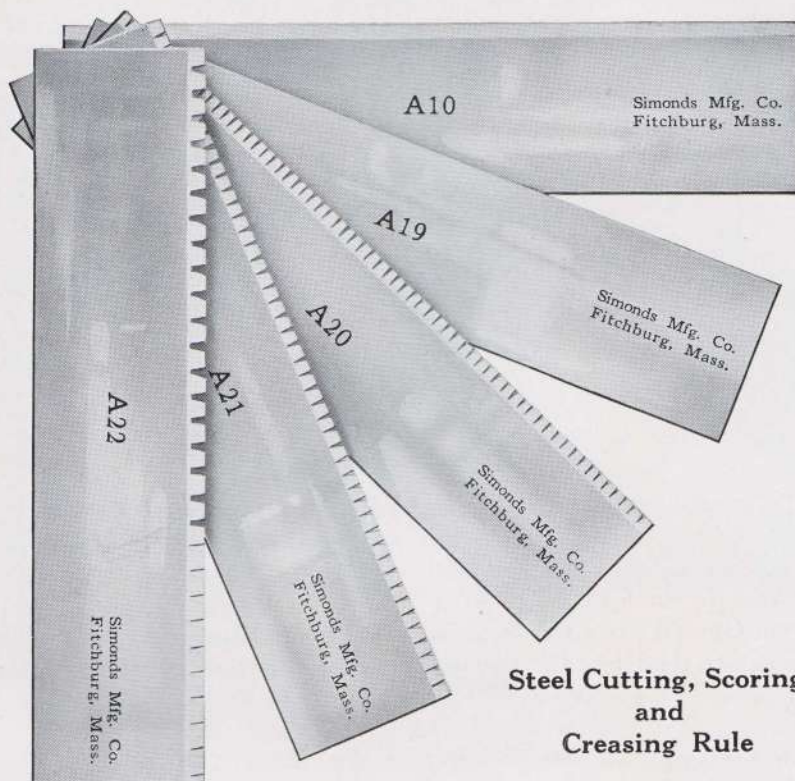

Steel Cutting, Scoring and Creasing Rule

Number	Name	Height	Thickness	Description	List Price Per Foot
A-10	2 Point Cutting	.923 inch	.029 inch	Hard Black	\$0.10
A-11	3 " "	.923 "	.042 "	" "	.13 $\frac{1}{2}$
A-12	4 " "	.923 "	.057 "	" "	.17
A-13	6 " "	.923 "	.083 "	" "	.24
A-14	2 " "	.923 "	.029 "	Hard and Polished	.10
A-15	3 " "	.923 "	.042 "	" " "	.13 $\frac{1}{2}$
A-16	4 " "	.923 "	.057 "	" " "	.17
A-17	6 " "	.923 "	.083 "	" " "	.24
A-18	2 " "	.923 "	.029 "	Soft	.10
A-19	2 " Creasing	.918 "	.029 "	Hard	.11

Scoring and Soft Cutting Rule, same price. Creasing, hard or soft, 2, 3, 4, or 6 points, advance 10 per cent over price of Cutting Rule. Special size Rule made to order.

Perforating Steel Rule

No.	Name	Height	Thickness	Description	List Price Per Foot
A-20	2 Point Perforating	.937 inch	.029 inch	17 teeth to inch, Hard and Polished	\$0.25
A-21	2 " "	.937 "	.029 "	12 " " " " " "	.25
A-22	2 " "	.937 "	.029 "	8 $\frac{1}{2}$ " " " " " "	.25

(Price 3-Point Perforating Rule, 25 per cent above 2-Point Rule.)

We make all Steel Rule in 30 inch or 24 inch strips, as desired.

Write for Discounts

Simonds Crescent Ground Cross-Cut Saws

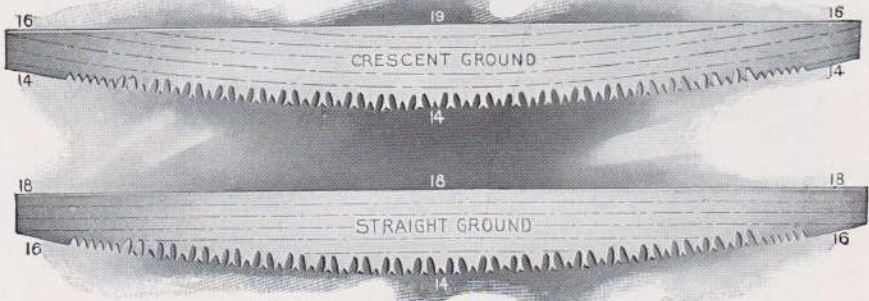

The Advantage

To grind Cross-Cut Saws in crescent lines parallel to the cutting edge of the saw is "Crescent Grinding." The advantage given by an even thickness throughout the tooth edge and a gradual taper from the tooth edge to the back is *less set* to the teeth and *less kerf* to cut. Our Crescent Ground Cross-Cut Saws have five gauges taper from the middle of the saw to the back, and two gauges taper from the ends of saw to the back.

No Binding in the Kerf

Note in the illustration of a *straight ground* saw the difference in thickness or gauge of the teeth at the end and at the center of the saw. You will see by comparing this with the illustration of the *Crescent Ground* that in the case of the Crescent Ground the teeth are of even thickness throughout the entire length of the saw, thus giving the same relative taper and clearance at all parts or sections of the saw, and making binding in the kerf impossible. This added strength given to the saw enables the operator to push as well as pull the saw.

Crescent Grinding is exclusively a Simonds Process.

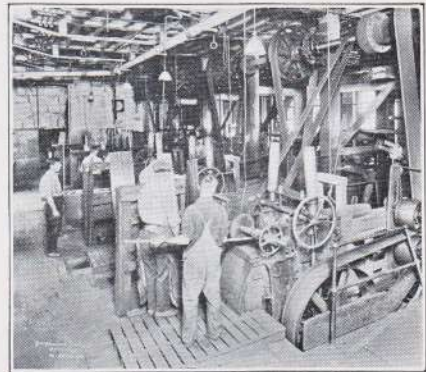

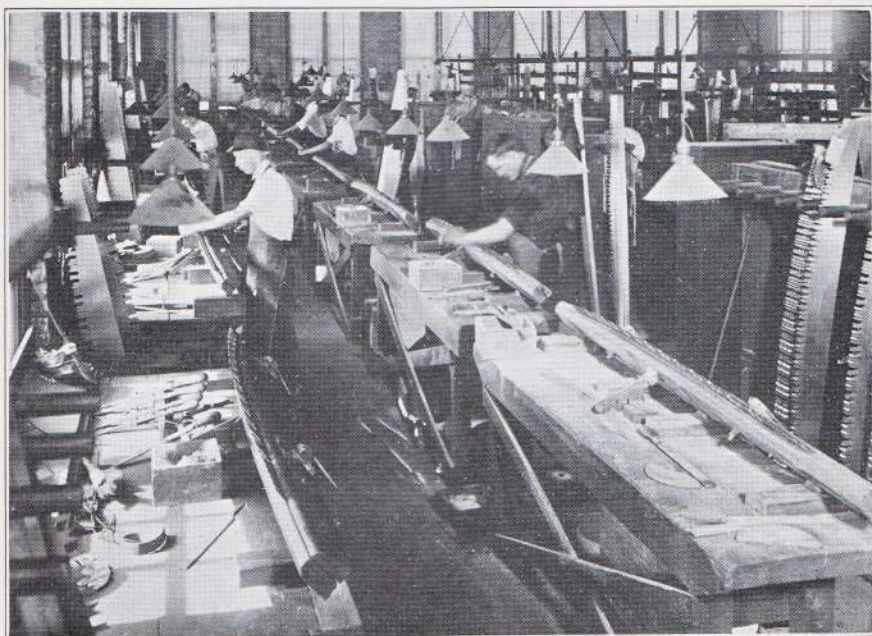

Simonds Steel

Simonds Steel is made in our own Crucible Steel Mill exclusively for Simonds Saws. It is the only steel that we are sure will take a *temper to hold a cutting edge* longer than the ordinary saw. Chemical analysis, special accuracy, and trueness govern every detail of manufacture. These features added to our surpassing Crescent Grinding permit us to offer you an absolute guaranty.

Superiority Guaranteed

The Simonds Saw, Crescent Ground, will cut *ten per cent more timber, same time and labor being used, than any other brand of saw made in the United States.*

The Simonds Cross-Cut Saw, Crescent Ground, is now universally known. For many years in use, no saw has ever been returned because our warranty, as above printed, was not fulfilled.

Simonds Crescent Ground Cross-Cut Saws



No. 12. Two Cutting Teeth to each Raker.



No. 13. Two Cutting Teeth to each Raker. Like No. 12 Saw except that teeth are coarser.



No. 22. Lance Tooth. Four Cutters to each Raker.

The above saws are 15 gauge on teeth edge and 20 gauge on back in the lengths under 6 feet. 6 feet and over are 14 x 19 gauge.

Length, feet	4	5	6	7	8
Weight each, lbs.	3¼	5¼	7½	9½	11½

See Discount Sheet for Prices

Simonds Crescent Ground Cross-Cut Saws



No. 33 Three Cutting Teeth to each Raker



No. 44. Roomy gullet between each set of 3 teeth that readily carries the sawdust from the cut.



No. 55. Roomy gullet between each set of 2 teeth.

The above saws are 15 gauge on teeth edge and 20 gauge on back in the lengths under 6 feet. 6 feet and over are 14 x 19 gauge.

Length, feet	4	4½	5	5½	6	6½	7	7½	8
Weight, each lbs.	3¼	4¼	5¼	6¼	7½	8½	9½	10½	11½

See Discount Sheet for Prices

Simonds Crescent Ground Cross-Cut Saws



No. 66. Two Lance Teeth to each Raker.

Length, feet	4	4½	5	5½	6	6½	7	7½	8
Weight, each lbs.	3¼	4¼	5¼	6¼	7½	8½	9½	10½	11½



No. 77. Regular Peg Tooth.

Length, feet	4	4½	5	5½	6	6½	7	7½	8
Weight, each lbs.	3¼	4¼	5¼	6¼	7½	8½	9½	10½	11½



No. 113. Two Cutting Teeth to each Raker.

Length, feet	4½	5	5½	6	6½	7	7½	8
Weight, each lbs.	3½	4¼	5	5¾	6½	7¼	8	8¾

The above saws are 15 gauge on teeth edge and 20 gauge on back in the lengths under 6 feet. 6 feet and over are 14 x 19 gauge.

See Discount Sheet for Prices

Simonds Crescent Ground Felling Saws



No. 133. Four Perforated Lance Teeth to each Raker. 14 x 19 gauge.

Length, feet	4½	5	5½	6	6½	7	7½	8
Weight each, lbs.	3½	4¼	5	5¾	6½	7¼	8	8¾



No. 315. Two Coarse Cutting Teeth to each Raker.

Length, feet	4	4½	5	5½	6	6½	7
Weight each, lbs.	3½	4	4½	5	5½	6	6½



No. 325. Lance Tooth. Four Cutting Teeth to each Raker.

Length, feet	4	4½	5	5½	6	6½	7
Weight each, lbs.	3½	4	4½	5	5½	6	6½

See Discount Sheet for Prices

Simonds Crescent Ground Cross-Cut Saws Cottonwood Patterns

Slightly narrower than regular wide saws



No 316

No. 316. Two Cutting Teeth to each Raker.

Length, feet	5	5½	6	6½	7	7½	8
Weight each, lbs.	4½	5¼	6	6¾	7½	8¼	9



No 324

No. 324. Lance Tooth. Four Cutting Teeth to each Raker.

Length, feet	5	5½	6	6½	7	7½	8
Weight each, lbs.	4½	5¼	6	6¾	7½	8¼	9



No 326

No. 326. Two Cutting Teeth to each Raker.

Length, feet	5	5½	6	6½	7	7½	8
Weight each, lbs.	4½	5¼	6	6¾	7½	8¼	9

The above saws are 15 gauge on teeth edge and 20 gauge on back in the lengths under 6 feet. 6 feet and over are 14 x 19 gauge.

See Discount Sheet for Prices

Simonds Crescent Ground Cross-Cut Saws

Made Especially for the Australian Trade

The extensive line of high grade Cross-Cut Saws here offered the Australian trade is the result of a careful study of the saw requirements in that country. In the Crescent Ground Saw will be found the greatest amount of speed coupled with ease of sawing. These saws all have a full five gauge taper.



No. 375. Australian Sleeper Cutter Saw. Made in 5½, 6, 6½ and 7 foot lengths. Specially ground for Sleeper Cutting.



No. 376. Australian Diamond Point Saw.

These two saws are made 14 gauge on teeth edge and 19 gauge on back.

Length, feet	5	5½	6	6½	7	7½	8
Weight each, lbs.	5½	6½	7½	8½	9½	10½	11½

See Discount Sheet for Prices

Simonds Crescent Ground Cross-Cut Saws

Made Especially for the Australian Trade



No. 383. Australian Faller's Saw, "M" Tooth and Raker. Made in all lengths 7 to 9 feet.



No. 384. Australian Faller's Saw. Made only in 8 and 9 foot lengths.

The above saws are made 14 gauge on teeth edge and 19 gauge on back.

Length, feet	7	7½	8	8½	9
Weight each, lbs.	9½	10½	11½	12½	13½



The Simonds Saw tang is strong and durable, made to meet the special requirements of expert sawyers. A pair of tangs furnished without extra charge on all Australian Cross-Cut Saws.



See Discount Sheet for Prices

Bay State Cross-Cut Saws



See Discount Sheet for Prices

Bay State Cross-Cut Saws



No. 206. 14 X 18 gauge, Length, feet 4 4½ 5 5½ 6 6½ 7



No. 207. 14 X 18 gauge, Length, feet 4 4½ 5 5½ 6 6½ 7

No. 207 A. 14 X 16 gauge

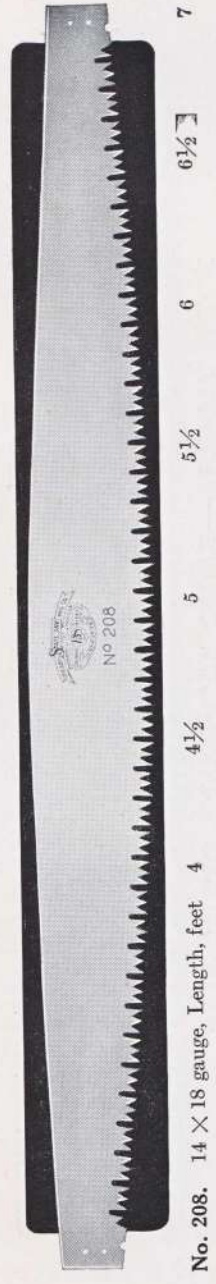

No. 208. 14 X 18 gauge, Length, feet 4 4½ 5 5½ 6 6½ 7

See Discount Sheet for Prices

Bay State Cross-Cut Saws—Hollow Back



No. 210. Length, feet 4 4½ 5 5½ 6 6½ 7 7½ 8



No. 211. Length, feet 4 4½ 5 5½ 6 6½ 7 7½ 8



No. 212. Length, feet 4 4½ 5 5½ 6 6½ 7 7½ 8

See Discount Sheet for Prices

Bay State Cross-Cut Saws—Hollow Back



No. 213. Length, feet 4 4½ 5 5½ 6 6½ 7 7½ 8



No. 214. Length, feet 4 4½ 5 5½ 6 6½ 7 7½ 8
 Length, feet 4 4½ 5 5½ 6 6½ 7 7½ 8

No. 0214 same as No. 214 except that No. 0214 is 2 gauge taper



No. 216. Length, feet 4 4½ 5 5½ 6 6½ 7 7½ 8

See Discount Sheet for Prices

Simonds Crescent Ground One Man Cross-Cut Saws



No. 223. Crescent Ground.

"Crescent Ground" Lance-Tooth One Man Saw. Accurately tapered from cutting edge to back. An even gauge all along the tooth edge. It cuts easy and saws fast. Double-horn handle with large opening, enabling operator to use mitten or glove in winter. Fully warranted.

Length, feet	3	3½	4	4½	5	5½
Weight each, lbs.	3½	4¼	5	5¾	6½	7¼

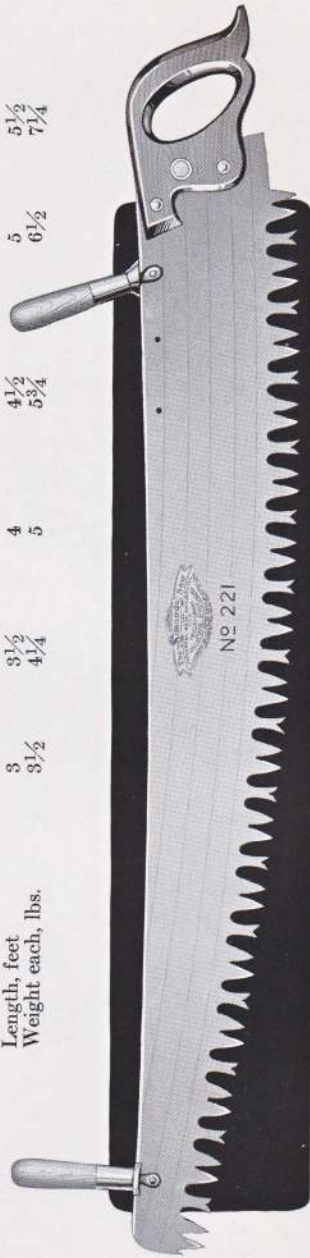

No. 221. Crescent Ground.

Made with tooth best for cutting hard timber. Tilted supplementary handle makes pushing and pulling easier and does not tire the sawyer's wrists. Three holes three inches apart permit adjusting the supplementary handle to a long or short arm man. An even gauge all along the circle of the cutting edge. Every tooth and raker works right. Fully warranted.

Length, feet	4	4½	5
Weight each, lbs.	5	5¾	6½

See Discount Sheet for Prices

Simonds Crescent Ground One Man Cross-Cut Saws

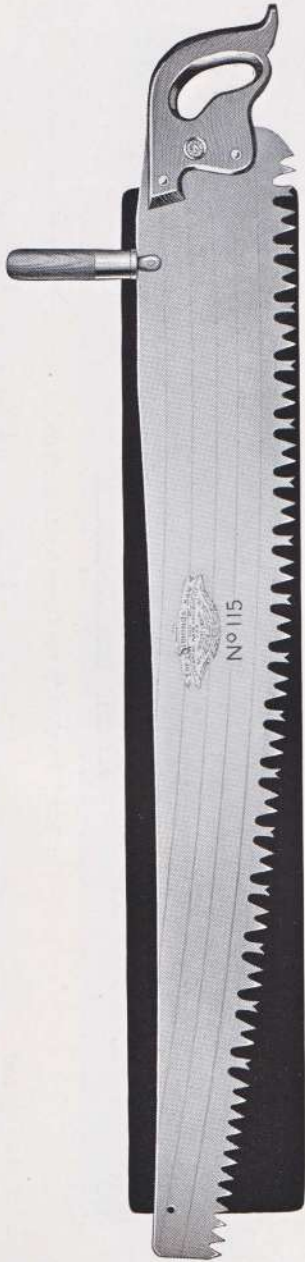

No. 115. Crescent Ground—Two Cutting Teeth to each Raker

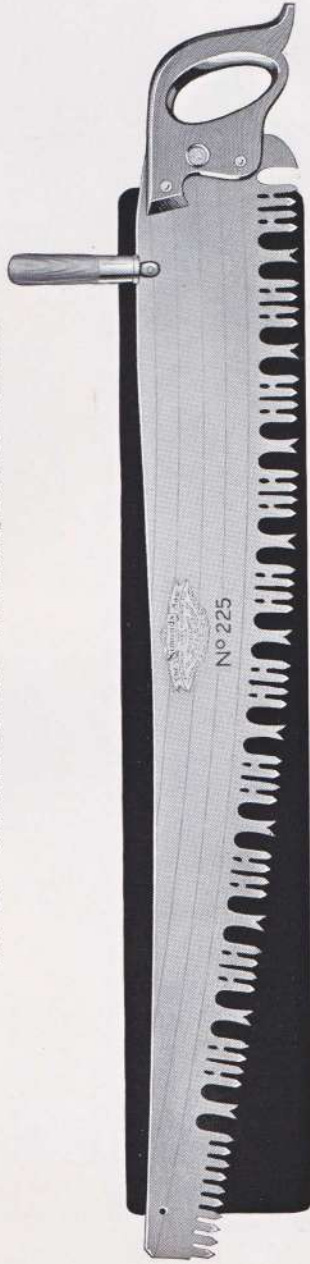

No. 225. Crescent Ground—Lance Tooth

These two improved One Man Saws represent the highest grade of saws, both as to steel quality and workmanship. They are made to secure the greatest ease and speed in cutting. The man who has much use for a One Man Saw will appreciate the great advantage of using this type of high-grade saw.

Length, feet	3	3½	4	5	6	7
Weight each, lbs.	3½	4¼	5	6½	7½	8½

See Discount Sheet for Prices

Simonds One Man Cross-Cut Saws



No. 111. Straight Taper Ground. Tuttle Tooth.

Length, feet	3	3½	4	4½	5	5½
Weight each, lbs.	3¼	4	4¾	5½	6½	7¾

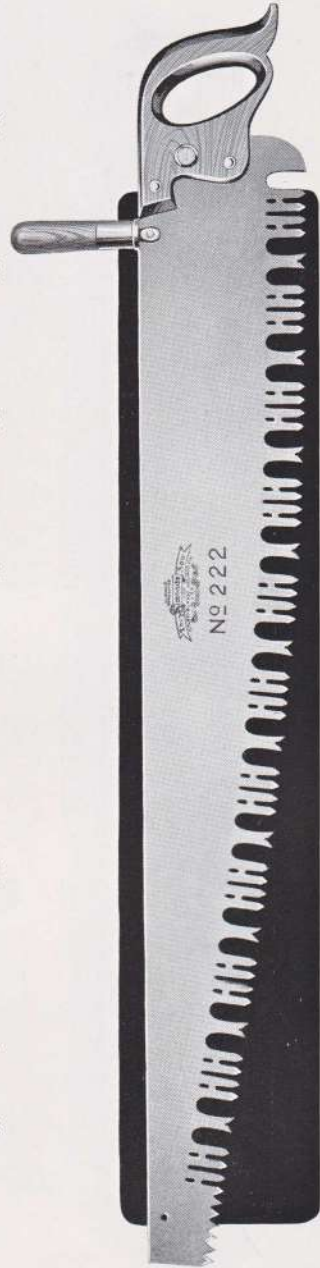

No. 222. Straight Taper Ground. Lance Tooth.

Length, feet	3	3½	4	4½	5	5½
Weight each, lbs.	3¼	4	4¾	5½	6½	7¾

See Discount Sheet for Prices

Simonds One Man Cross-Cut Saws

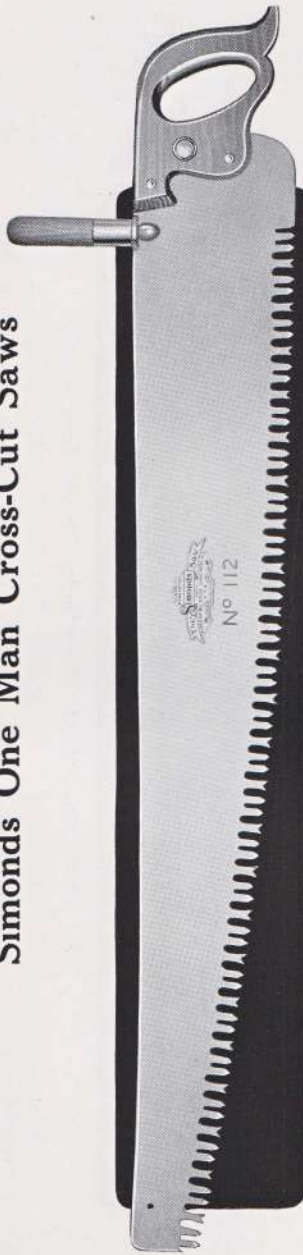

No. 112. Two slim cutting Teeth and Raker. Sway Back. Straight Taper Ground.

Length, feet	3	3½	4	4½	5	5½
Weight each, lbs.	3	3¼	4½	5¼	6	6¾



No. 224. Sway Back. Straight Taper Ground.

Length, feet	3	3½	4	4½	5	5½
Weight each, lbs.	3	3¼	4½	5¼	6	6¾

See Discount Sheet for Prices

Simonds One Man Cross-Cut Saws



No. 237. Lance Tooth. Sway Back. Straight Taper Ground.

Length, feet	3	3½	4	5	5½
Weight, each lbs.	3	3¾	4½	5¼	6¾



No. 238. Chinook Tooth. Sway Back. Straight Taper Ground.

Length, feet	3	3½	4	5	5½
Weight each, lbs.	3	3¾	4½	5¼	6¾

See Discount Sheet for Prices

Simonds One Man Cross-Cut Saws



No. 444. Straight Taper Ground.

Length, feet	3	3½	4	4½	5	5½
Weight each, lbs.	3¼	4	4¾	5½	6½	7½



No. 777. Straight Taper Ground. Straight Back. Peg Tooth.

Length, feet	3	3½	4	4½	5	5½
Weight each, lbs.	3¼	4	4¾	5½	6½	7½

See Discount Sheet for Prices

Bay State One Man Cross-Cut Saws



No. 231.	Length, feet	3	3½	4	4½	5
	Weight each, lbs.	3¼	4	4¾	5½	6½



No. 233.	Length, feet	3	3½	4	4½	5
	Weight each, lbs.	3¼	4	4¾	5½	6½

See Discount Sheet for Prices

Saw Tool No. B2

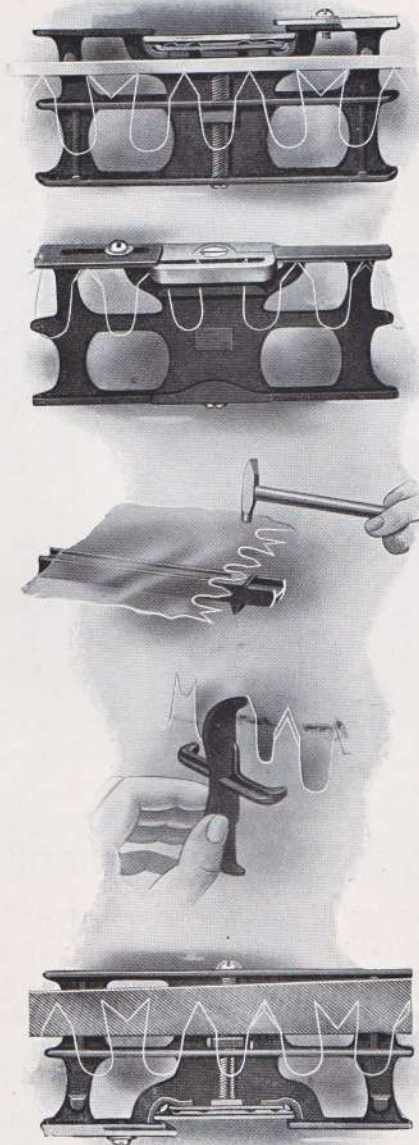

This tool was designed for the use of lumbermen and is appreciated by all users of cross-cut saws. It is light and convenient to carry in the pocket or to use in the woods. Packed one set in a box.

See Discount Sheets for Prices.

Simonds Improved Crescent Saw Tools, No. 342

Patented April 10, 1917

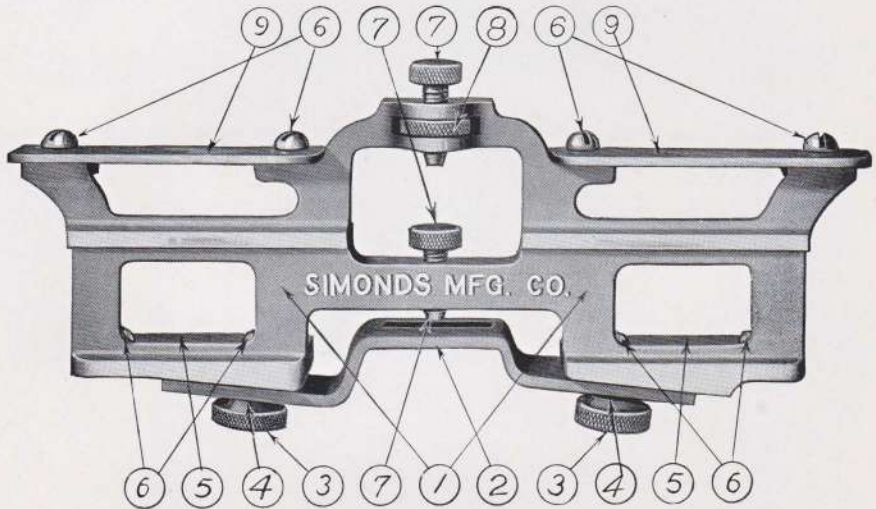

Advantages of the Simonds Improved Crescent Saw Tool

Quick, accurate, and rigid adjustment of Raker Gauge.

No chance to dislocate slide when once set in position, — a feature not to be found in any other saw tool on the market.

Easy and rigid adjustment of jointing file. File is held square with the body of the saw.

Depth of raker tooth can be varied from 1-16 of an inch to 1-1000 of an inch, the slide being held firmly in all positions.

Hardened steel plates and screws are furnished throughout on all wearing surfaces. This prevents the fine adjustment of the tool becoming altered owing to wear when in use.

All parts of this tool are interchangeable, and may be replaced.

Instructions for operating and complete list of all parts enclosed with each tool.

List Prices

Set complete, including tool, set gauge, and block, but without hammer . . .	per doz.
Drop Forged Cast Steel Hammer, No. 346	per doz

See Discount Sheet for Prices

Simonds Improved Crescent Saw Tools, No. 342

Patented April 10, 1917

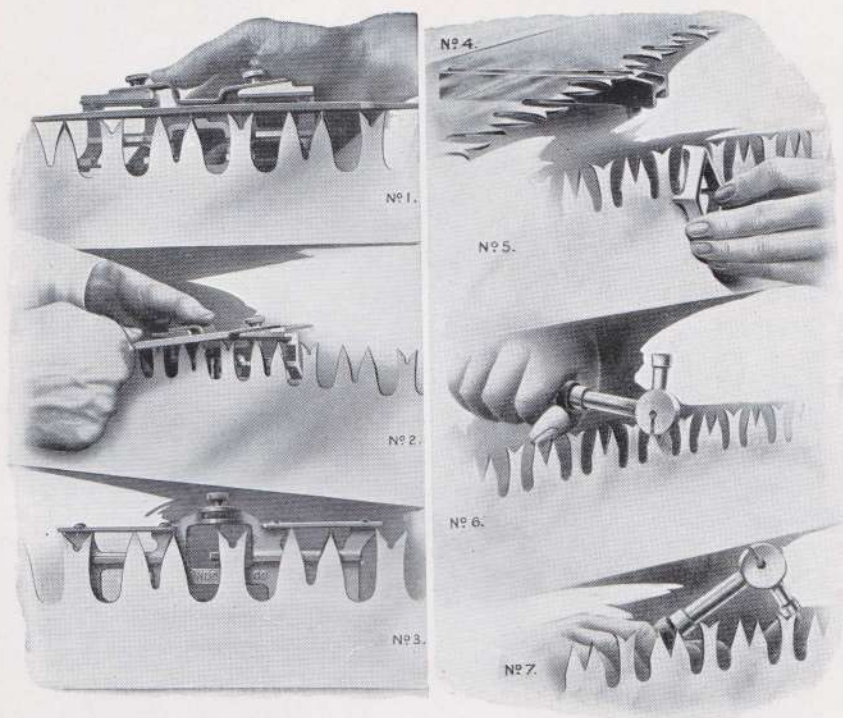

No. 1. Jointing the Saw

“ 2. Filing Raker or Cleaner Teeth

“ 3. Gauging length of Raker or
Cleaner Teeth

No. 4. Setting Stake

“ 5. Set Gauge

“ 6. Spring Setting

“ 7. Swaging Raker Teeth

The Simonds Crescent Saw Tools

Patented August 29, 1899

No. 340

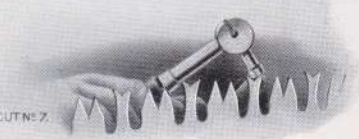
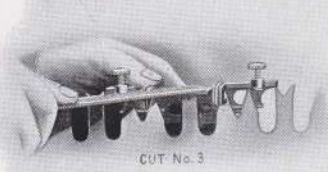
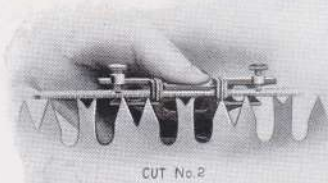
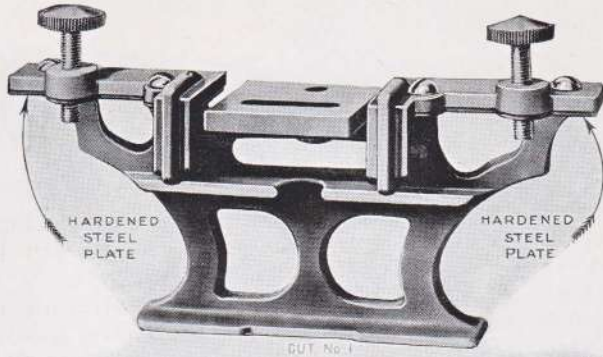

Price per dozen sets, without hammer
 Drop-forged Tool Steel Hammers, per dozen, No. 346

See Discount Sheet for Prices

Simonds Cross-Cut Saw Handles



No. 44. Handle

This Cross-cut Saw Handle is the strongest handle made. Steel loop running the full length of handle and screwing into malleable cap and nut combined on end of handle as illustrated. The cap and ferrule through which it passes form a lock and brace and at the same time strengthen it.

Steel swivel attached to ferrule.

Length of handle, 7 inches.

Shipping weight 200 lbs. per 100 pairs.

Packed 100 pairs in case.

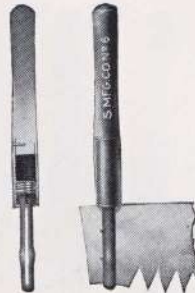

No. 6. Handle

Made with malleable iron loop casting, the loop screwing up into a threaded ferrule at the bottom of the handle.

Ferrule made exceptionally strong, bringing liability of breakage down to a minimum.

Weight per case of 100 pairs, 184 lbs.

No. 66. Handle

Handle same style as No. 6 but with heavier handle and castings.

Weight per case of 50 pairs, 117 lbs.

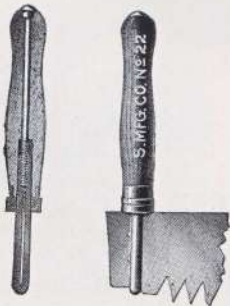

No. 22. Handle

Seasoned hardwood handle with extra steel bolt running down from top of handle to screw into ferrule of heavy steel loop.

Weight per case of 100 pairs, 199 lbs.

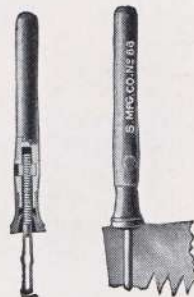

No. 88. Handle

Loop Handle. Strong and serviceable with very strong steel loop, screwing into malleable nut.

Weight per case of 100 pairs, 204 lbs.

See Discount Sheet for Prices

Simonds Cross-Cut Saw Handles



No. 100. Handle

A sturdy loop handle with strong steel loop screwing into a malleable nut.

Weight per barrel of 100 pairs, 100 lbs.



No. 111. Handle

Easily adjusted reversible handle. Malleable castings. Strong steel bolt with extra large wing nut which holds castings solidly in place.

Weight per case of 100 pairs, 173 lbs.

No. 111B. Handle

Same style handle as No. 111. The heavier and better quality malleable castings add greatly to the strength, insuring much longer service.

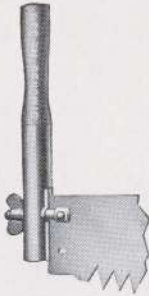

No. 396. Handle

A handle that will stand hard service owing to the heavy malleable iron ferrule with milled steel pin and wing nut, which holds the handle firmly in place on the end of the saw.

Weight per case of 50 pairs, 140 lbs.



No. 390. Regular One Man Handle with large hand hole.

No. 391. Regular One Man Handle with small hand hole.

No. 393. Two Horn One Man Handle, same as used on Saw No. 223.

No. 392. One Man Supplementary Handle.



See Discount Sheet for Prices

Pond Ice Saw No. 350



Width at Butt	Width at Point	Thickness	LIST PRICE, WITHOUT HANDLE						
			3 feet	3½ feet	4 feet	4½ feet	5 feet	5½ feet	6 feet
8 inch	6 inch	10 gauge	\$3.00	\$3.50	\$4.00	\$4.50	\$5.00	\$5.50	\$6.00 each
8 "	6 "	11 "	2.80	3.25	3.80	4.25	4.70	5.15	5.70 "
7 "	5 "	10 "	2.70	3.15	3.60	4.05	4.50	4.95	5.40 "
7 "	5 "	11 "	2.55	2.95	3.40	3.85	4.25	4.70	5.10 "

No. 352. Tiller Handles, complete, for above saws . . .

Hand Ice Saw No. 359

Hollow back, regular tooth

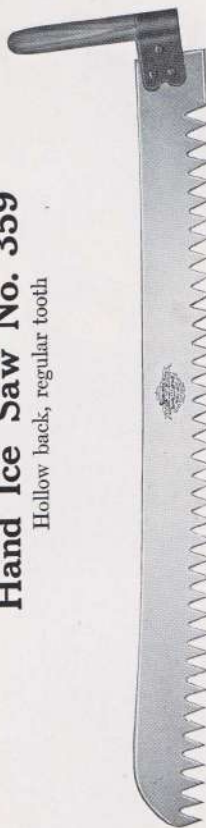

Length	24	26	28	30	32	34 inches
List Price	\$10.50	\$11.50	\$12.50	\$13.50	\$14.50	\$15.50 per dozen

Write for Discounts

Hand Ice Saws

For Wagon Use



No. 355

Beech Handle, Polished Edges

Length	24	26	28	30 inches
List Price	\$16.00	\$17.00	\$18.00	\$19.00 per dozen

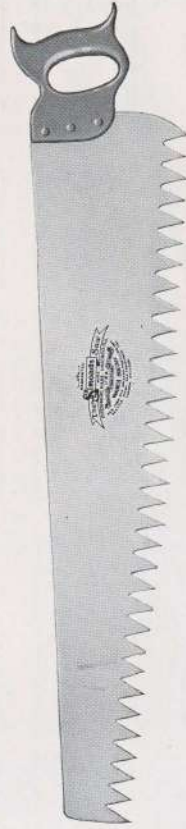

No. 357

Malleable Iron Handle

Length	24	26	28	30 inches
List Price	\$19.00	\$20.00	\$21.00	\$22.00 per dozen

Write for Discounts



When Selling a Hand Saw

Explain to your customer the points of interest about the saws you are selling.

He may be a carpenter, and thoroughly familiar with the use of saws; but you are a merchant, and are equally well posted on the facts concerning saws, so you, in a nice way, can talk your line to your customer in terms which he not only understands but which commands his respectful attention.

Tell why there are different priced saws.

All Simonds Brand Saws are ground with four gauges taper from tooth edge to back and from toe to heel. Grinding is slow, expensive work, but it adds very greatly to the value of a saw. Saws not full taper ground will bind in the cut, and it would be a waste of money for a good carpenter to bother with such a saw at any price, no matter how cheap.

Simonds Saws are made of steel made in Simonds' own Steel Mill, and therefore the metal has an edge-holding quality not found in saws made of ordinary steel which has not had the specialized saw-making attention that has been given Simonds Steel.

Saw Steel is the product of experience.



We claim that Simonds Saws hang correctly, are ground perhaps closer to gauge, and therefore hang lighter in the hand, than any other make of saw on the market.

Handles should be made of thoroughly seasoned wood, so that they will never check or crack. Simonds applewood is seasoned for three years under our own direction before being made into handles.

Handles that are carved and polished may be of no better quality than plain handles, but they look better and cost more to make.

The handles should be attractive. Each one is fitted to the blade individually and fastened firmly with four or five brass screws. Most Simonds Saw handles are highly polished, thoroughly seasoned, fine-grained applewood. A few are beechwood.

Carpenters take pride in their saws, and want them to be a credit to their tool kits.

The Simonds Blue Ribbon Saws are the most attractive appearing high-grade saws ever offered the trade. They are made with the one idea of getting an article as nearly perfect as human skill can make it.

Spring temper is given a saw by careful heat treatment. Take a Simonds Saw and bend it double, watching how it regains its line with wonderful spring. Take the handle in both hands and whip the blade in the air. Feel the play of it as a fisherman tests a rod or a teamster a whip.

Test the hang of the saw by holding it down on a line with the arm from the shoulder, pointing the saw to the ground in front of the body. Feel how the weight comes where the most cutting takes place.

Saws are uniformly and properly filed and set when leaving the factory. However, many carpenters have their own preference as to style of filing, and are able easily to file their new saws according to their own style.



Simonds Blue Ribbon Hand Saws

Standard Sizes

With the aim of simplifying Hand Saw Stock in Dealers' stores, the Simonds Saw and Steel Company has adopted standard styles to reduce the number of saws needed for a complete stock.

A full line of Manufacturer's Brand Saws consisting of an extra high grade for the expert workman who wants nothing but the best both in quality and finish; a medium priced grade, which although equal in quality is not so finely finished, for the man who wants a high grade saw but is not particular about its appearance, and a moderate priced saw for general work on the farm, in school shops and around the home.

These saws are illustrated on the three pages immediately following. The saws with 6 in the numbers are the extra high grade. Those with 7 in the numbers are the medium priced.

Simonds extra high grade "Blue Ribbon" Saws, numbers 61, 62, 361 and 362 are made of Simonds Crucible Steel which is manufactured in our own Steel Mills. Excellent steel, right temper, accurate workmanship in every process of the manufacture produces saws distinctive in appearance and unexcelled in quality. The blades are full taper ground finished with a high gloss polish. Handles of seasoned applewood, smoothly polished and carved on grip and flat.

The Simonds medium priced "Blue Ribbon" Saws, numbers 71, 72, 371 and 372 are made from the same steel and with equal care as the extra grade saws. The difference is that they do not have the high gloss finish blade and the handle is carved on the grip only.

Simonds Blue Ribbon Hand Saws



No. 61. Straight Back

Stock Sizes: 26 inch Hand, 7, 8, 9 or 10 point; 26 inch Rip, 5½ or 6 point.



No. 361. Narrow Straight Back

Stock Sizes: 26 inch Hand, 7, 8, 9, 10 or 11 point.



No. 62. Skew Back

Stock Sizes: 20 inch Panel; 10 point; 22 inch Panel; 9, 10 or 11 point; 24 inch Panel, 8, 9 or 10 point; 26 inch Hand, 7, 8, 9 or 10 point; 26 inch Rip, 5, 5½ or 6 point.

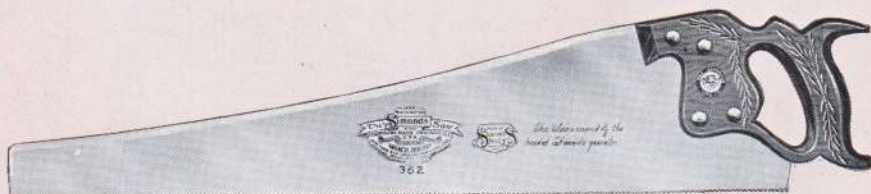

No. 362. Narrow Skew Back

Stock Sizes: 26 inch Hand, 7, 8, 9, 10 or 11 point.

See Discount Sheet for Prices

Simonds Blue Ribbon Hand Saws

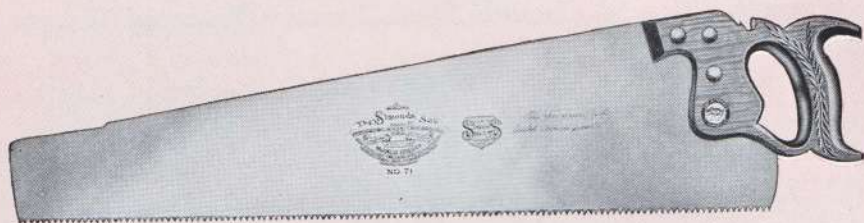

No. 71. Straight Back

Stock Sizes: 24 inch Panel, 8 or 9 point; 26 inch Hand, 7, 8, 9, or 10 point; 26 inch Rip, 5, 5½ or 6 point.



No. 371 Straight Back, Narrow

Stock Sizes: 22 inch Panel, 9, 10 or 11 point; 24 inch Panel, 8, 9 or 10 point; 26 inch Hand, 7, 8, 9, 10 or 11 point; 26 inch Rip, 5, 5½ or 6 point.



No. 72. Skew Back

Stock Sizes: 20 inch and 22 inch Panels, 8, 9, 10, 11 or 12 point; 24 inch Panel, 8, 9, or 10 point; 26 inch Hand, 6, 7, 8, 9 or 10 point; 24 inch Rip, 6 point; 26 inch Rip, 5, 5½ or 6 point.



No. 372. Skew Back, Narrow

Stock Sizes: 22 inch Panel, 9, 10, 11 or 12 point; 24 inch Panel, 8, 9 or 10 point; 26 inch Hand, 7, 8, 9, 10 or 11 point; 26 inch Rip, 5, 5½ or 6 point.

See Discount Sheet for Prices

Simonds Hand Saws

Warranted Special Crucible Steel, Simonds Patented Temper



No. 10. Straight Back, Medium Width

Manufacturer's own brand Hand Saw at a price that immediately appeals to those who desire a general purpose saw—such as farmers, manual training students, and the worker around the home. Full taper ground blades, made of selected steel. Polished beech handle. A splendid value at a moderate price. Stock sizes: 18 inch and 20 inch Panel, 9, 10, 11 or 12 point; 22 inch Panel, 8, 9, 10, 11 or 12 point; 24 inch Panel, 7, 8, 9 or 10 point; 26 inch Hand, 6, 7, 8, 9, or 10 point; 26 inch Rip, 5, 5½ or 6 point.



No. 10½. Skew Back, Full Width

This number is the same quality and finish as the No. 10. Made with full width skew back, selected steel blades. These two saws are covered by the broadest Simonds warranty. The quality of material and workmanship is unequalled for the price. Stock sizes: 18 inch, 20 inch and 22 inch Panels, 8, 9, 10, 11 or 12 point; 24 inch Panel, 7, 8, 9, 10, 11 or 12 point; 24 inch Rip, 5½ or 6 point; 26 inch Hand, 6, 7, 8, 9, 10, 11 or 12 point; 26 inch Rip, 5, 5½ or 6 point.

See Discount Sheet for Prices

Every Saw bearing the Simonds Trade-Mark is absolutely guaranteed against any and all defects, and is made to retail at a moderate price.

Simonds Saws

Warranted Special Crucible Steel, Simonds Patented Temper

No. 58. Flooring Saw.



Special Crucible Steel. Warranted Applewood Handle with polished edges. Four screws. Made for cutting through floors or flat surfaces. Made only in 20-inch length with 8 points to the inch.

No. 14. Joiner or Bench Saw

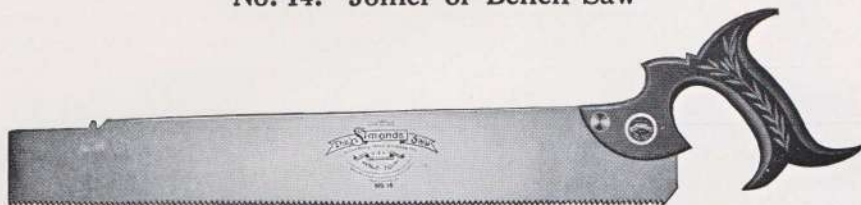

Special Crucible Steel, Warranted, Carved and Highly Polished Apple Handle, Two Screws, Length, 17 inches.

No. 15. Hack Hand Saws

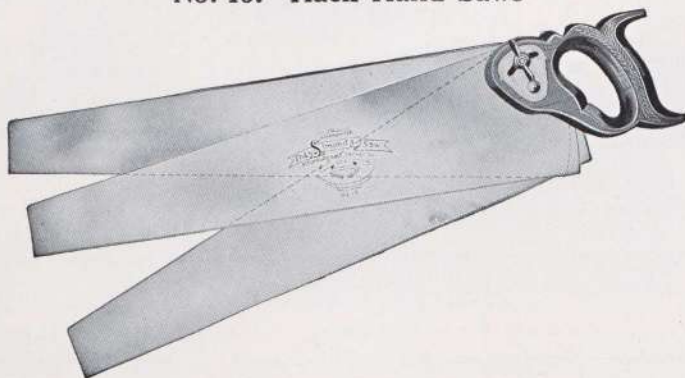

Special Crucible Steel, Warranted, Carved and Highly Polished Adjustable Apple Handle. Simonds Patented Temper, especially high for cutting Metal, Nails, etc., Taper Ground for Clearance. Made in 16, 18, 20, 22, 24 and 26 inch lengths.

See Discount Sheets for Prices

Bay State Saw Manufacturing Co's

Warranted Crucible Steel, Patented Temper, Hand, Panel and Rip Saws

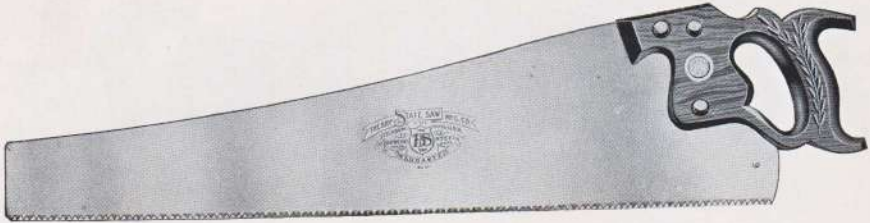

No. 25. Crucible Steel, Warranted, Carved Beech Handle, Skew Back, Four Screws.

Points	PANEL			HAND	RIP			
	8 to 11	7 to 12	6 to 12		6 to 12	6 & 7	5, 5½, 6	4½, 5, 5½
Length, inches .	18	20	22	24	26	24	26	28



No. 26. Crucible Steel, Warranted, Carved Beech Handle, Straight Back, Four Screws.

Points	PANEL				HAND	RIP			
	8 to 12	7 to 11	7 to 12	6 to 10		6 to 10	6 & 7	5, 5½, 6	5
Length, inches .	18	20	22	24	26	24	26	28	

Packed one-third dozen in a box.

See Discount Sheet for Prices

King Philip

Son of Massasoit. Prominent in early New England History



No. 42. Skew Back

Mohawk

An Indian Tribe of North America, one of the Five Nations



No. 141. Straight Back

List Prices Nos. 42 and 141. Cast Steel, Polished Blade, Warranted, Beech Handle, Polished Sides and Edges, Four Screws

Length, inches	16	18	20	22	24	26	28
--------------------------	----	----	----	----	----	----	----

Osceola

Chief of the Seminoles, Florida

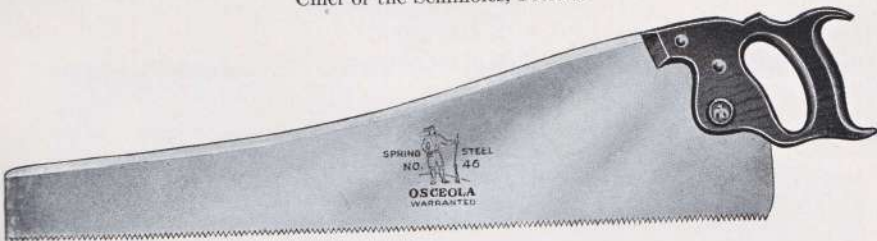

No. 46

List Prices. Cast Steel, Skew Back. Furnished with Bright Blade. Warranted, Beech Handle, Polished Edges, Three Screws

Length, inches	16	18	20	22	24	26	28
--------------------------	----	----	----	----	----	----	----

Above saws packed one-half dozen in a box

See Discount Sheet for Prices

The Sioux

Prominent among the more recent Indian tribes



No. 47. Cast Steel, Straight Back, Polished Blade, Beech Handle, with Polished Steel Plate, Three Screws

Points	PANEL						HAND	RIP
	8 to 11				6 to 10		6 to 11	5, 5½
Length, inches .	14	16	18	20	22	24	26	26 28

Iroquois

Foremost Tribe in New York State



No. 49. Cast Steel, Beech Handle, Polished Edges, Three Screws

Points	PANEL						HAND	RIP
	8 to 12	7 to 12	7 to 11	6 to 10	6 to 10	6 to 10	5, 5½, 6 5, 5½	
Length, inches .	16	18 20	22	24	26	26	28	

Pontiac

Chief of the Ottawas



No. 50. Beech Handle, Three Screws

Points	PANEL						HAND	RIP
	8 to 12			7 to 12	7 to 11	6 to 10	6 to 10	5, 5½, 6
Length, inches .	12	14 16	18	20	22 24	26	26	

Packed one-half dozen in a box.
See Discount Sheet for Prices

Simonds Nests of Saws



No. 79. Simonds Nest of Saws with adjustable handle, patented April 21, 1908. Combining one each, 10 inch Keyhole, 12 inch Compass, and 16 inch Table or Pruning Saw.

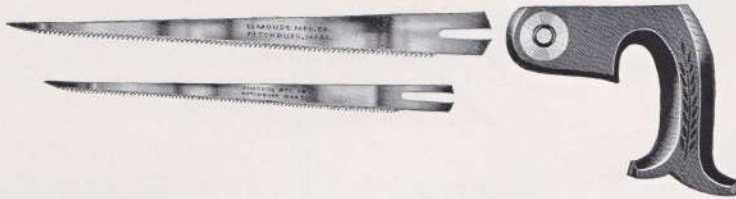

No. 80. Simonds Nest of Saws with patented adjustable handle, combining one each, 10 inch Keyhole and 12 inch Compass Saws.

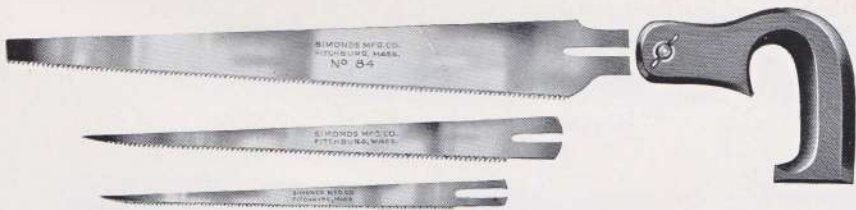

No. 84. Nest of Saws. Combining one each, 10 inch Keyhole, 12 inch Compass, and 16 inch Table or Pruning Saw.



No. 85. Nest of Saws. Combining one each, 10 inch Keyhole and 12 inch Compass Saws.

See Discount Sheet for Prices

Adjustments

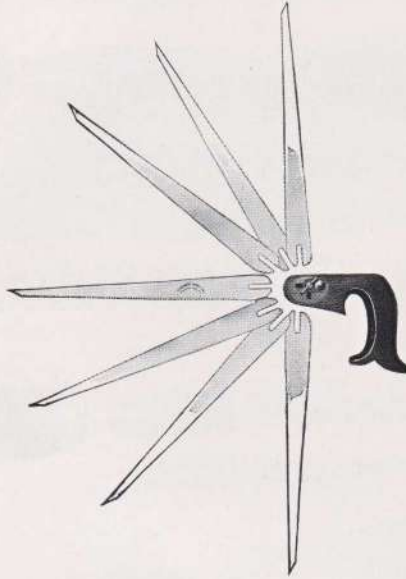

This illustrates a few of the many positions in which blades can be used with our new patented adjustable handle such as furnished with Nos. 79, 80, 81, and 83. The tooth edge of the blade can be either up or down.

Plumber's Nest of Saws



No. 83. Nest of Saws with metal cutting blade and patented adjustable handle.

Complete, including Handle, 10 inch Keyhole Blade,
12 inch Compass Blade, and 18 inch Nail Cutting
Blade

Packed four sets in box

Extra Nail Cutting Blades, 18 inch

See Discount Sheet for Prices

Simonds Compass Saws

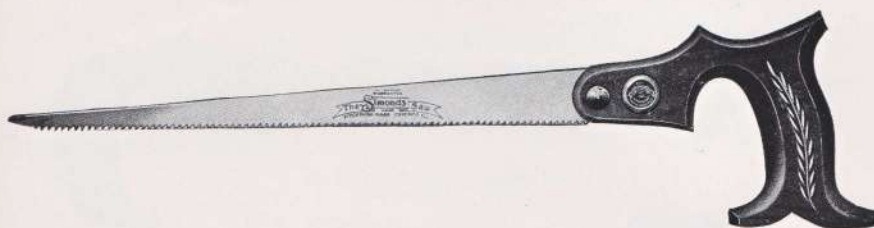

No. 116. Simonds Compass Saw. Improved Shaped Apple Handle
 10 12 14 16 inches
 Packed one-half dozen in box.



No. 87. Simonds Compass Saw, Crucible Steel, Apple Handle
 Warranted
 10 12 14 16 inches
 Packed one-half dozen in box



No. 88. Compass Saw, Crucible Steel, Beech Handle
 12 14 16 inches
 Packed one-half dozen in box

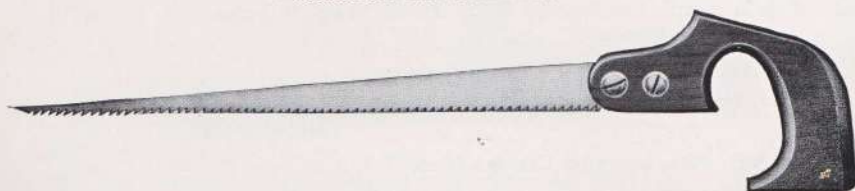

No. 94. Compass Saw, 12, 14, and 16 inches
 Packed one-half dozen in box
 See Discount Sheet for Prices

Simonds Compass Saws



No. 78. Simonds Interchangeable Compass Saw. Plain handle with polished edges. Metal ferrule with screw adjustment, allowing interchange of blades. Blades held firmly in handle. Tooth edge can be faced either up or down. Packed one-half dozen in a box.

Made in the following lengths: 8, 10, 12, 14 and 16 inches.

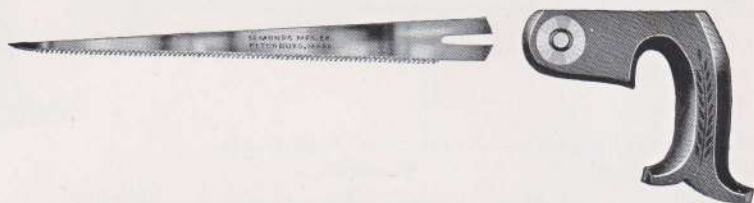

No. 81. Simonds Compass Saw with patented adjustable handle.

Made in the following lengths: 10, 12, 14, 16, 18 and 20 inches.



No. 86. Interchangeable Compass Saw. Handle and blade complete.

Made in the following lengths: 10, 12, 14, 16, 18 and 20 inches.



No. 86B Interchangeable Compass Blades.

Made in the following lengths: 10, 12, 14, 16 and 18 inches.

Above Saws packed one-half dozen in box

See Discount Sheet for Prices

Simonds Keyhole Saws

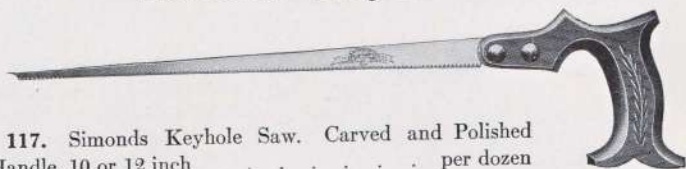

No. 117. Simonds Keyhole Saw. Carved and Polished Apple Handle 10 or 12 inch per dozen

Packed one-half dozen in box.



No. 89. Bay State Saw Mfg. Co., Keyhole Saw, Beech Handle Packed one dozen in box, 12 inch per dozen

No. 82. Simonds Keyhole Saw with patented adjustable pad. Illustration shows various positions in which blade and handle can be set. Will fold neatly for packing.

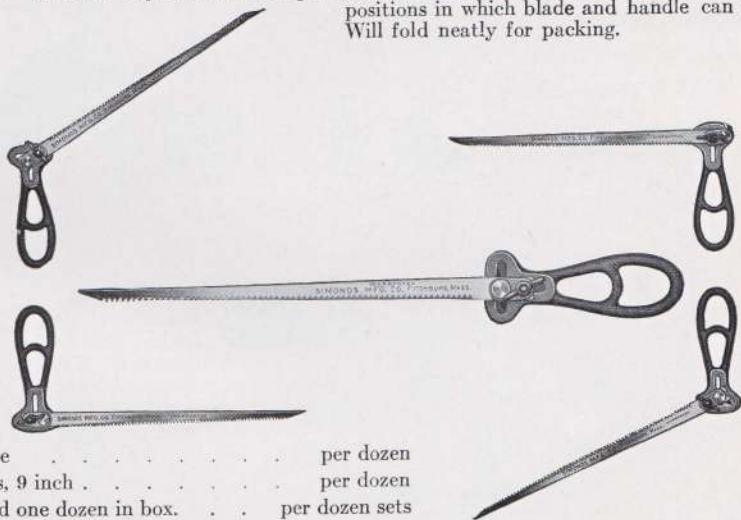

Handle per dozen
Blades, 9 inch per dozen
Packed one dozen in box. per dozen sets

Keyhole Saw and Pad



No. 90. Keyhole Saw and Handle, complete

No. 91. Cast Steel Keyhole Saw Blades, extra ground, set and sharpened

No. 92. Cast Steel Reversible Keyhole Saw Blades

No. 93. Cast Steel Blind-Makers' Saw Blades

Packed one dozen in box

See Discount Sheet for Prices

Simonds Miscellaneous Saws

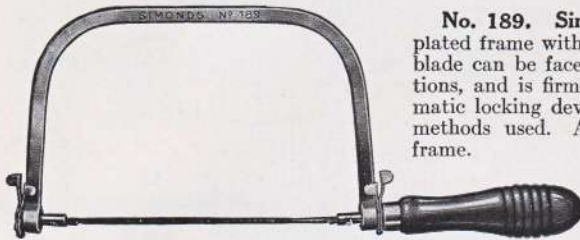

No. 189. Simonds Coping Saw. Nickel-plated frame with polished birch handle. The blade can be faced in any one of eight directions, and is firmly held in place by an automatic locking device which is superior to other methods used. A blade furnished with each frame.

Packed one-half dozen in a box

No. 189B. Simonds Coping Saw Blades

Extra 6-inch blades.

No. 166. Pattern Maker's Saw. Apple Handle, blade $7\frac{1}{2}$ x $1\frac{1}{4}$ inches, 21 gauge, 15 points.

Packed one in a box.



No. 168. Dovetail Saw. Polished handle, brass plated steel back, Simonds Crucible Steel blade, $1\frac{1}{2}$ inches wide under back, 26 gauge, 17 points to the inch.

6 8 10 12 inches

Packed one-sixth dozen in a box

No. 170. Back Saw. Prof. Ball Pattern. Apple Handle, polished edges, brass plated steel back, Simonds Crucible Steel blade, $1\frac{1}{2}$ inches wide under back, 26 gauge, 17 points to the inch.

Packed one sixth dozen in a box

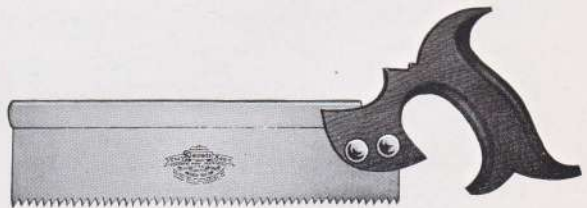

6 8 10 12 inches

See Discount Sheet for Prices

Crucible Steel Back Saw



No. 95. Crucible Steel Mitre Box Saws, Apple Handle, Polished Edges, Blued Steel Back, Set and Hand Filed, ready for use. Warranted. Toothed Edge, 2 inches shorter than the full length of Blade.

Furnished in the following sizes.

4 Inches under Back: 18, 20, 22, 24, 26, 28, 30, 32 inches.

5 Inches under Back: 24, 26, 28, 30, 32 inches.

6 Inches under Back: 22, 24, 26, 28, 30, 32 inches.



No. 96. Crucible Steel Blade, Apple Handle, Polished Edges, Blued Steel Back, Set and Hand Filed, ready for use. Warranted.

8 10 12 14 16 18 inches

Packed one-third dozen in box

See Discount Sheet for Prices

Crucible Steel Back Saws

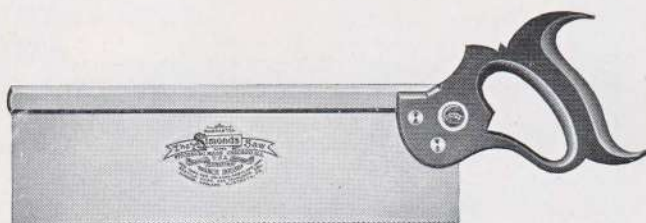

No. 97. Crucible Steel Blade, Beech Handle, Polished Edges, Blued Back, Set and Hand Filed, ready for use. Warranted.

8 10 12 14 16 18 inches

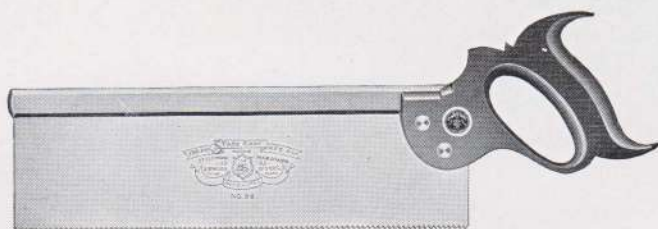

No. 98. Beech Handle, Polished Edges, Blued Back.

8 10 12 14 16 18 inches

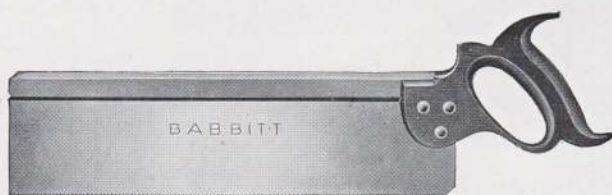

No. 99. Babbitt Back Saw, Beech Handle, Polished Edges, Blued Back.

10 12 14 inches

Packed one-third dozen in box

See Discount Sheet for Prices

No. 348. Simonds Docking or Framing Saw



An easy-cutting handy saw for Lumbermen to use around docks and yards where rough ends of boards or planks need to be sawed off. Also for Bridge Builders, Scale Builders, Carpenters, House Framing, and for the Farm wood-yard. Full-breasted blade with bevel filed teeth, $4\frac{1}{2}$ points to the inch, 18-gauge on cutting edge, taper ground for clearance. Malleable iron handle, firmly riveted to blade. This saw can also be furnished with a removable wooden handle and thumb screw, when so specified, at the same price.

List Price, 24 inch per dozen
 List Price, 39 inch per dozen

No. 347. Same as No. 348, excepting furnished with Wood Handle having large roomy hand hole.

Pruning Saws



No. 63. Simonds Pruning Saw. Beech Handle with varnished edges. Three brass screws. Crucible Steel Blade, 20 inches long, having "M" teeth at the heel and common teeth at the point. 8 points to the inch.

Packed one-third dozen in box



No. 73. Simonds Pruning Saw. Beech Handle with varnished edges. Three brass screws. Crucible Steel Blade, 20 inches long, with 7, 8, or 9 points to the inch.

Packed one-third dozen in box

See Discount Sheet for Prices

Simonds Pruning Saws

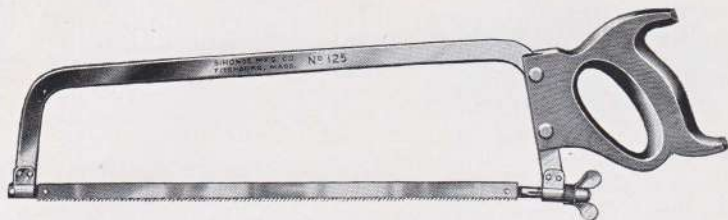

No. 125. Flat Steel Frame, Beech Handle, Varnished Edges, Blued Steel Blade. $14\frac{1}{2}$ inches between centers of holes.

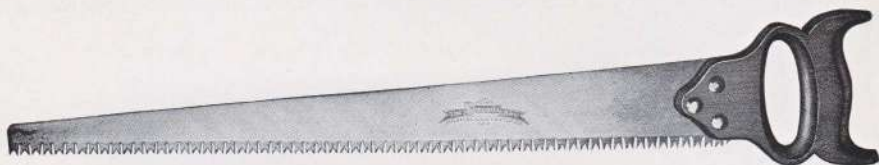

No. 128. Simonds Warranted Crucible Steel Blade, Lightning Tooth, Apple Handle. Polished Edges, Three Screws. Made in 20 inch length only.



No. 130. The same blade as used on No. 128 saw, fitted with a "Pistol Grip" Apple-wood Handle. A very popular saw. Made in 20 inch length only.

See Discount Sheet for Prices

Table and Pruning Saws



No. 64. Simonds Crucible Steel, Warranted, Apple Handle, Polished Edge, Two Screws

16 18 20 22 inches

Packed one-third dozen in box



No. 74. Bay State Saw Mfg. Co., Beech Handle, Polished Edge, Two Screws.

16 18 20 22 inches

Packed one-third dozen in box



No. 65. Simonds Crucible Steel, Double Edge, Warranted

14 16 18 20 22 inches

Packed one-half dozen in box



No. 75. Bay State Saw Mfg. Co., Crucible Steel, Double Edge

14 16 18 20 22 inches

Packed one-half dozen in box

See Discount Sheet for Prices

Simonds Pruning Saws



No. 67. California Pruning, Crucible Steel, Warranted

Beech handle, polished edges. Three brass screws. Blade taper ground. Set and filed.

Price, 12 inch per dozen

Price, 14 inch per dozen

Packed one-half dozen in box



No. 68. Curved Pruning, 18 gauge, 8 points to the inch.

No. 129. Curved Pruning, 20 gauge, 8 points to the inch.

Beech handle. Two nickeled screws. Crucible steel blade. Set and filed.

Price, 12 inch per dozen

Price, 14 inch per dozen

Packed one-half dozen in box

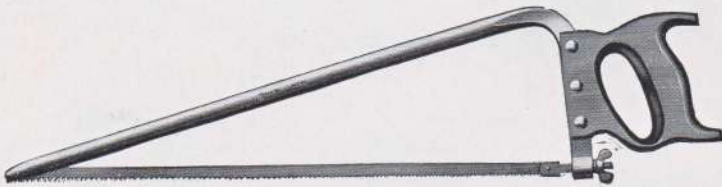

No. 69. Tapered Pruning Saw

Oval steel back. Beech handle with varnished edges. Blued steel blade, 20 inches long.

Price, per dozen

Packed one-third dozen in box

See Discount Sheet for Prices

Simonds Butcher Saws

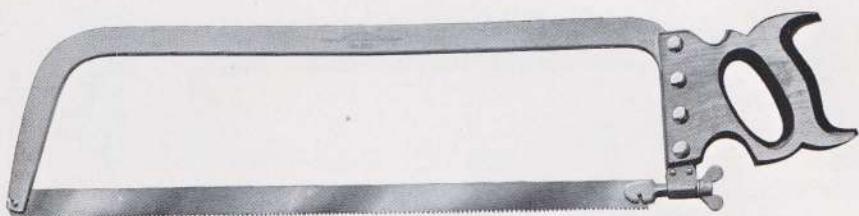

No. 250. California Pattern, Beech Handle, Flat Steel Back 1 inch \times $\frac{1}{4}$ inch, round edge. Depth from tooth edge of blade to inside edge of 24 inch frame, $5\frac{1}{2}$ inches. Blued blade 1 inch wide.

18 20 22 24 26 inches

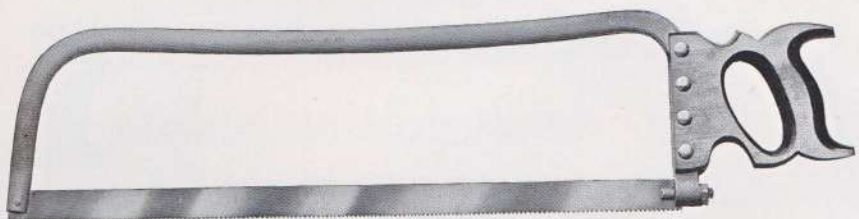

No. 251. California Pattern, Beech Handle, Oval Steel Back $\frac{3}{4}$ inch \times $\frac{3}{8}$ inch. Depth from tooth edge of blade to inside edge of 24 inch frame, $5\frac{1}{2}$ inches. Blued blade $\frac{1}{2}$ inch wide.

16 18 20 22 24 26 inches

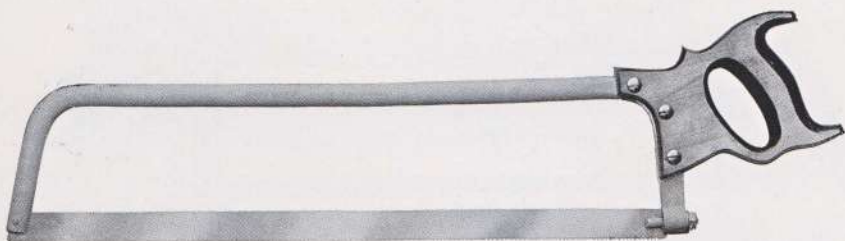

No. 253. Beech Handle, Oval Steel Back $\frac{3}{4}$ inch \times $\frac{3}{8}$ inch. Depth from tooth edge of blade to inside edge of 24 inch frame, $4\frac{3}{4}$ inches. Bright blade 1 inch wide.

14 16 18 20 22 24 inches

See Discount Sheet for Prices

Simonds Butcher Saws

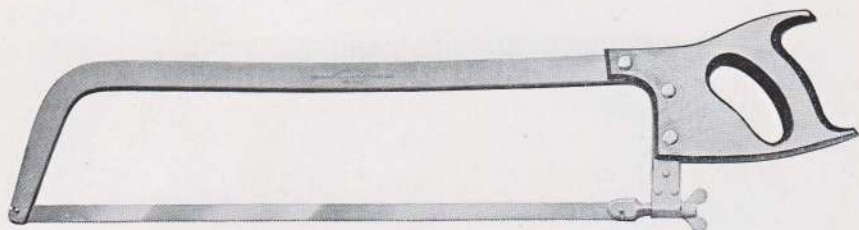

No. 255. Beech Handle, Flat Steel Back 1 inch \times $\frac{1}{4}$ inch, round edge. Depth from tooth edge of blade to inside edge of 24 inch frame, $4\frac{3}{4}$ inches. Bright blade $\frac{5}{8}$ inch wide.

16 18 20 22 24 26 28 inches

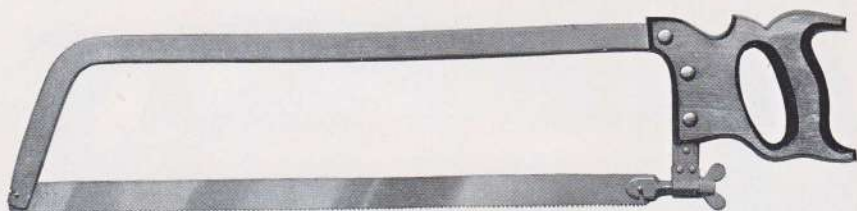

No. 256. Beech Handle, Flat Steel Back $\frac{7}{8}$ inch \times $\frac{3}{16}$ inch, round edge. Depth from tooth edge of blade to inside edge of 24 inch frame, $4\frac{1}{4}$ inches. Bright blade 1 inch wide.

14 16 18 20 22 24 inches

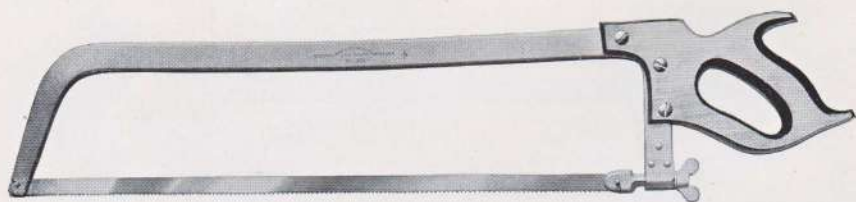

No. 261. Beech Handle, Flat Steel Back 1 inch \times $\frac{1}{4}$ inch, round edge. Depth from tooth edge of blade to inside edge of 24 inch frame, $4\frac{3}{4}$ inches. Bright blade $\frac{5}{8}$ inch wide.

16 18 20 22 24 26 28 30 inches

Packed one third dozen in box

See Discount Sheet for Prices

Simonds Kitchen Saws

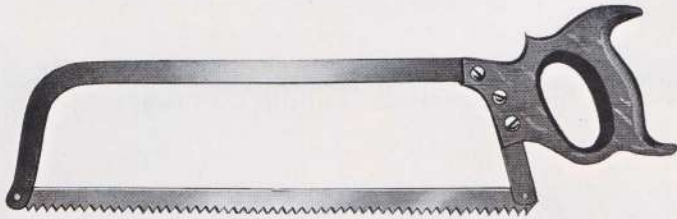

No. 265. Kitchen Saw, Flat Back $\frac{5}{8}$ inch \times $\frac{3}{16}$ inch. Bright blade $\frac{3}{4}$ inch wide.

14

16

18 inches

Packed one half dozen in box

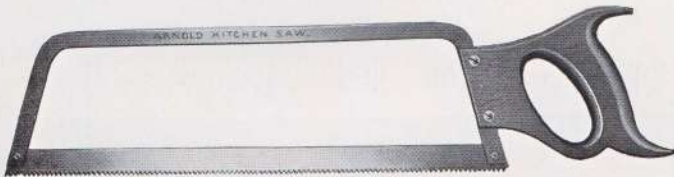

No. 257. Arnold Kitchen Saw, Flat Back $\frac{1}{2}$ inch \times $\frac{3}{16}$ inch. Bright blade $\frac{5}{8}$ inch wide.

12

14

16 inches

Packed one half dozen in box



No. 264. Kitchen Saw, Oval Back $\frac{1}{2}$ inch \times $\frac{1}{4}$ inch. Bright blade $\frac{5}{8}$ inch wide.

12

14

16 inches

Packed one half dozen in box

See Discount Sheet for Prices

Simonds Beef Splitting Saws



No. 259. Beef Splitter, Apple Handles, Flat Steel Back, $1\frac{3}{8}$ inch \times $\frac{5}{16}$ inch, round edge. Depth from tooth edge of blade to inside edge of frame $6\frac{5}{8}$ inches. Heavy bright blade 2 inches wide.

34

36 inches

The size of a Beef Splitting Saw is obtained by measuring the length of the blade, over all.

Packed one-third dozen in box



No. 260. Beef Splitter, Beech Handle, Flat Steel Back, $1\frac{3}{8}$ inches \times $\frac{1}{4}$ inch, round edge. Depth from tooth edge of blade to inside edge of 24 inch frame, $5\frac{5}{8}$ inches. Heavy bright blade $1\frac{1}{2}$ inches wide.

24

26

28

30

32

34

36 inches

Packed one-third dozen in box

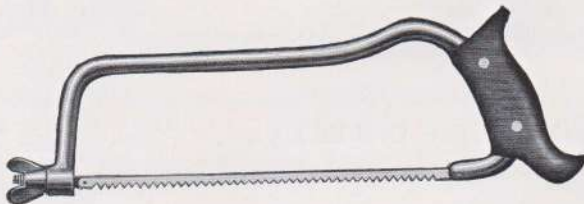

No. 268. Dehorning Saw, Japanned Frame, Beech Handle. Blade $9\frac{1}{2}$ inches long.

Packed one-half dozen in box

See Discount Sheet for Prices

No. 270. Butcher Saw Blades in Coils



Owing to the disadvantage of carrying several dozen of different lengths of Butcher Saw Blades in stock, we are now furnishing these Blades in coils of 50 feet. You are thus enabled to furnish, at any time, the right length. These Blades are made of the finest quality of steel, tempered, ground and polished, filed and set, with the proper tooth, ready for immediate use.

These blades 23 gauges thick, 11 points to inch.

Width, inches	$\frac{1}{2}$	$\frac{5}{8}$	$\frac{3}{4}$	1	$1\frac{1}{4}$	$1\frac{1}{2}$
---------------	---------------	---------------	---------------	---	----------------	----------------

Butcher Saw Blades

Best Crucible Steel. Packed one dozen in box

Butcher Saw Blades are furnished length over all without holes or pins unless specified. When ordered with holes, distance between center of holes should be given.



No. 258. Bright Blades from $\frac{1}{2}$ to $1\frac{1}{4}$ inches wide, 23 gauge, 11 point. Furnished in all lengths from 12 to 28 inches.

No. 258. Bright Blades $1\frac{1}{2}$ inches wide, 23 gauge, 11 point; 2 inches wide, 19 gauge, 8 point.

No. 258-B. Blued Blade $\frac{1}{2}$ to $1\frac{1}{4}$ inches wide, 23 gauge, 11 point. Furnished all lengths from 12 to 28 inches.

No. 258-B. Blued Blade $1\frac{1}{2}$ inches wide, 23 gauge, 11 point; 2 inches wide, 19 gauge, 8 point. Furnished all lengths from 12 to 28 inches

No. 272. Butcher Saw Punch

Neat, handy, strong

Punches $\frac{5}{16}$ " Hole

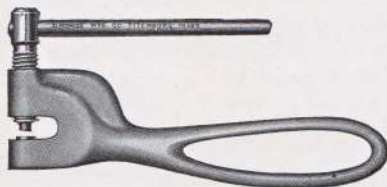

See Discount Sheet for Prices

Scrapers



No. 184
Wall Scrapers

3 inch Blade per dozen
4 inch Blade per dozen



No. 185
Butcher Block Scrapers

6 inch Blade per dozen



No. 186
Plain Cut Edges

No. 186A
Ground Even Gauge
Finished Edges

Cabinet Scrapers

Extra Quality

No. 186B
Ground 18 Gauge
Finished Edges
Straw color

No. 186C
Ground 21 Gauge
Finished Edges
Straw color, flexible

The above scrapers made in following sizes:

2 × 4
2 × 5
2 × 6

2½ × 4
2½ × 5
2½ × 6

3 × 4
3 × 5
3 × 6

3½ × 4
3½ × 5
3½ × 6

4 × 4
4 × 5
4 × 6
5 × 6

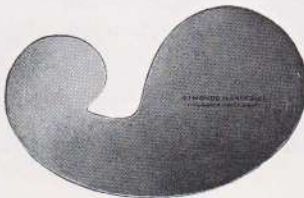

No. 187. Goose Neck

Size, 6½ × 3¼ 16 gauge
Price per dozen

All above scrapers packed one dozen in box.

No. 586. Flexible Scrapers

Five Straw Color Finished Edged Blades to each set. One each 21, 22, 23, 24 and 25 gauges thick. Each blade stamped with gauge number. Furnished in two sizes—2½" x 5", 3" x 6".



See Discount Sheet for Prices

Hand Saw Handles



For styles of handles refer to saws bearing the same numbers. Handles are furnished, slit without holes. Screws are not included unless specified. Handles are supplied to fit blades from 16 to 28 inches in length.

Handles for Hand Saw:

No. 72—Carved Applewood
 No. 61—Carved Applewood
 No. 71—Carved Applewood
 No. 10—Beech

No. 10½—Beech
 No. 25—Beech Carved
 No. 42—Beech
 No. 49—Beech Varnished Edges.

Compass Saw Handles



Handles for Compass Saw

No. 88—Beech
 No. 116—Applewood

Pruning Saw Handles



Handles for Pruning Saw

No. 74—Beech
 No. 75—Beech

Butcher Saw Handles



Handles for Butcher Saw

No. 250—Beech, not drilled or slit.
 No. 251— " " " " "
 No. 253— " " " " "
 No. 255— " " " " "

For styles of handles, see saw bearing same number.

All of the above packed one dozen in a box

See Discount Sheet for Prices

Handles and Screws



Back Saw Handles

For style of handle, refer to saw bearing same number. Back Saw handles are furnished to fit blades from 8 to 16 inches in length.

Handles for Saw 98—Beech, slit only.
Handles for Saw 96—Beech, slit only.

Above packed one dozen in box.

Saw Screws



No. 10. Simonds



No. 20. Simonds.

No. 10. Simonds, Small Brass.

No. 20. Simonds, Large Brass.



No. 1. Plain



No. 2. Plain

No. 1. Plain, Small Brass.

No. 2. Plain, Large Brass.



No. 10. Eagle



No. 20. Eagle

No. 10. Eagle, Small Nickel.

No. 20. Eagle, Large Nickel.

All above packed half gross in box.

See Discount Sheet for Prices

No. 339. Hand Saw Jointer

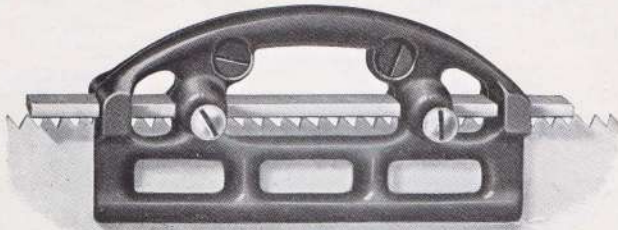

Adjustable to any thickness of saw blade, and may be used with any common file Japanned.

Packed one in a box

No. 198. Hand Saw Clamp

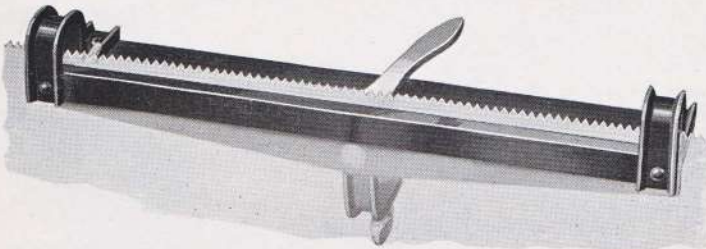

No. 197. Hand Saw Set

Will not slip, cut, or mar the teeth. Has but one gauge to set. Any setting may be reproduced. Anvil and punch easily replaced. Made of steel throughout. Fully guaranteed.

See Discount Sheet for Prices

Reversed Lever Saw Sets

Patented September 15, 1908

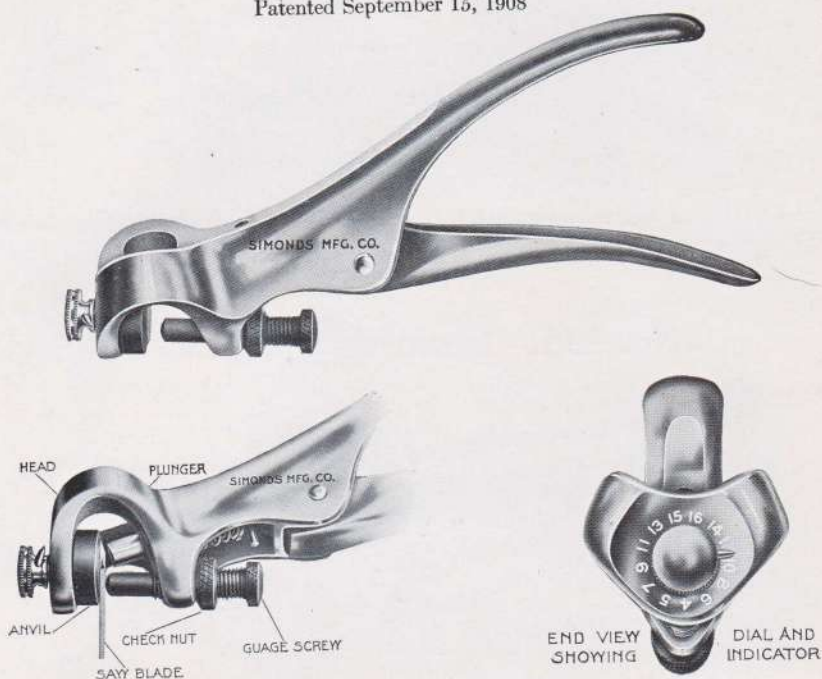

Combines the revolving anvil and indicator dial, with other features which give it marked practical advantages.

The lever is placed on the lower side of the body of the Saw Set, where it may be easily operated by moving the fingers only, without the motion of the entire hand.

There is a check nut on the gauge screw which prevents its becoming loosened while the set is in use.

The anvil revolves and is made in such a way that it has the required length and bevel for saw teeth, ranging from 4 to 16 to the inch, and it is easily adjusted by turning the indicator knob until the pointer is over the number corresponding to the number of teeth per inch in the saw that is to be set.

Hardened anvil and plunger. Finely tempered steel spring.

No. 331. Nickel Plated

No. 332. Gun Metal Finish, nickered trimmings

Packed one half dozen in box

See Discount Sheet for Prices

Lever Saw Sets

No. 334



Hardened anvil and plunger, tempered steel spring. The construction of the anvil adjustment is such that when the thumbscrew is loosened, the anvil cannot drop off.

Packed one-half dozen in box

Lever Saw Sets

No. 336

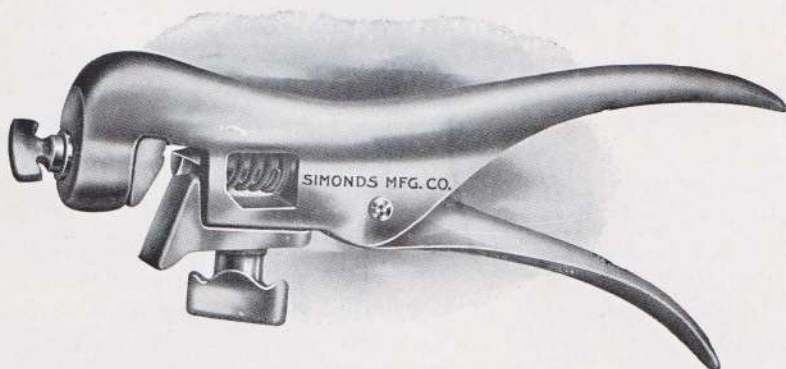

For Cross-Cut and Circular Saws from 14 to 20 gauge
Lever on lower side; anvil and plunger hardened; tempered steel spring. Polished.

Packed one-half dozen in box

See Discount Sheet for Prices

"Pistol Grip" Adjustable Saw Sets

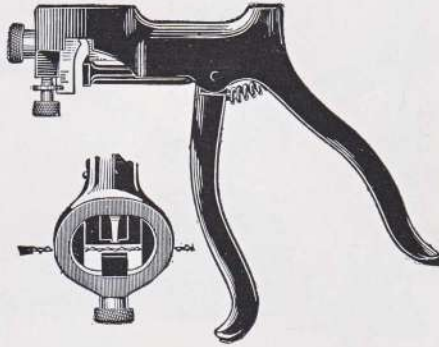

No. 42. The shape of the Body and Handle enables the user to operate the tool with great ease and with the least possible exertion. The saw is held firmly against the gauge while the tooth is being set.

It can be readily adjusted. As the anvil or part against which the plunger works is graduated, the same adjustment can be easily obtained for duplicate work.

The tool is so designed that the saw teeth are in plain view, which enables the user to quickly adjust the tool to the tooth to be set.

The plunger and anvil are made of tool steel,—hardened and tempered. All parts are carefully machined and are interchangeable.

The tool is given a fine black finish.

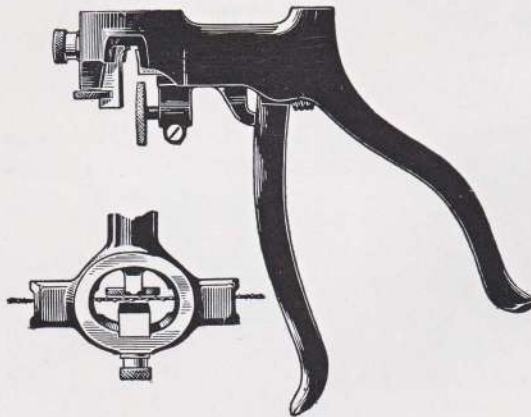

No. 43. For Cross-Cut Saws. The Number 43 "Pistol Grip" Saw Set is similar to the Number 42. It is also adjustable for thickness of saw blade. The stop plate should be set to bring the side of the saw against the highest point of the anvil and secured by means of the binding screw. When packed for shipment the tool is set for Cross-Cut Saws of average thickness.

Above Saw Sets packed one in a box

See Discount Sheet for Prices

Simonds Crescent Wood Saws Complete

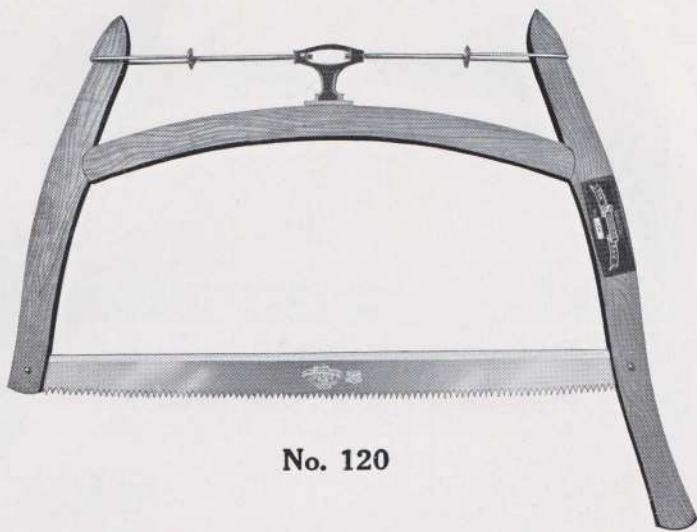

No. 120

Strong enough to support a man's weight. Large enough for the big logs. Arched brace with center fastened rod, making positively the strongest rigid high arch frame on the market.

Made of especially selected stock. Natural wood finish, varnished. Patented sliding or rocker joints, making an easily assembled, self-adjusting frame. Special strong rod.

Furnished regularly with blade No. 407, made of Simonds Crucible Steel, extra thin back, blued, $2\frac{1}{4}$ inches wide.

With 30-inch blades	\$	per dozen
With 32-inch blades	\$	per dozen

Packed one half dozen in box

For list price combination of the above frame and rod with other blades, deduct price of blade No. 407 and add price of the blade desired.

See Discount Sheet for Prices

Wood Saws Complete

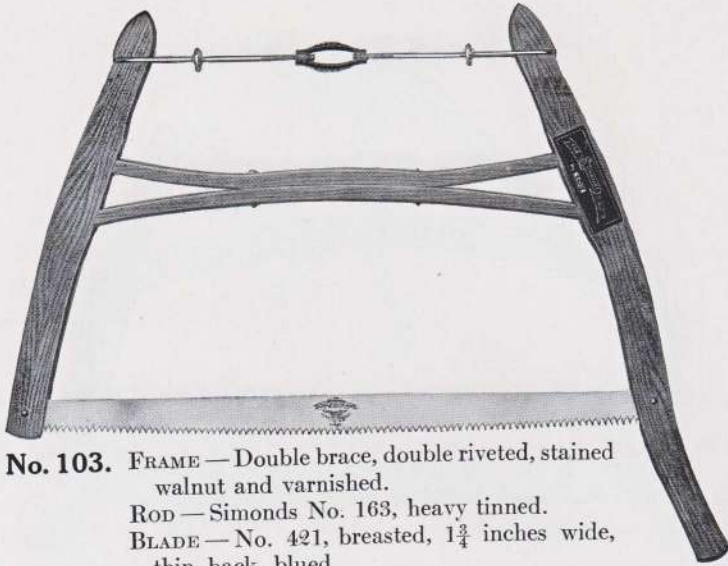

No. 103. FRAME—Double brace, double riveted, stained walnut and varnished.
 ROD—Simonds No. 163, heavy tinned.
 BLADE—No. 421, breasted, $1\frac{3}{4}$ inches wide, thin back, blued.

With 30 inch blades	per dozen
With 32 inch blades	per dozen

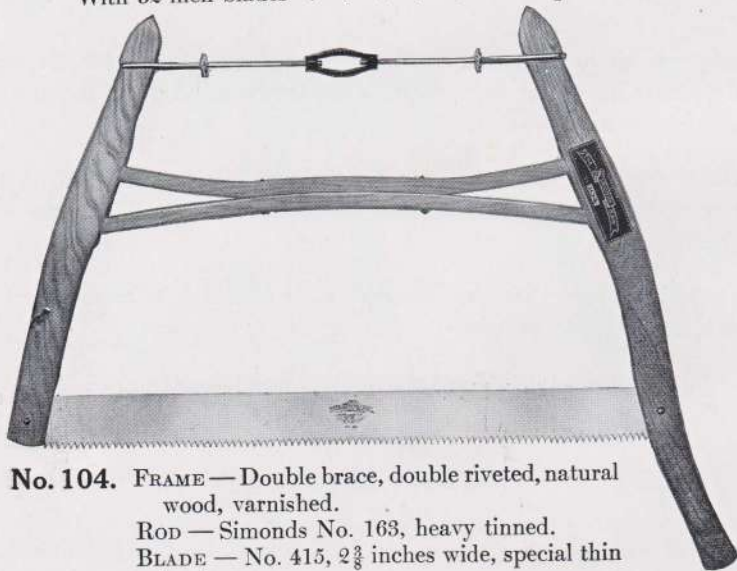

No. 104. FRAME—Double brace, double riveted, natural wood, varnished.
 ROD—Simonds No. 163, heavy tinned.
 BLADE—No. 415, $2\frac{3}{8}$ inches wide, special thin back.

With 30 inch blades	per dozen
With 32 inch blades	per dozen

For combinations of above frames with other rods or blades use separate list prices on frames, rods, and blades. Wood Saws packed one-half dozen in box.

See Discount Sheet for Prices

Wood Saws Complete

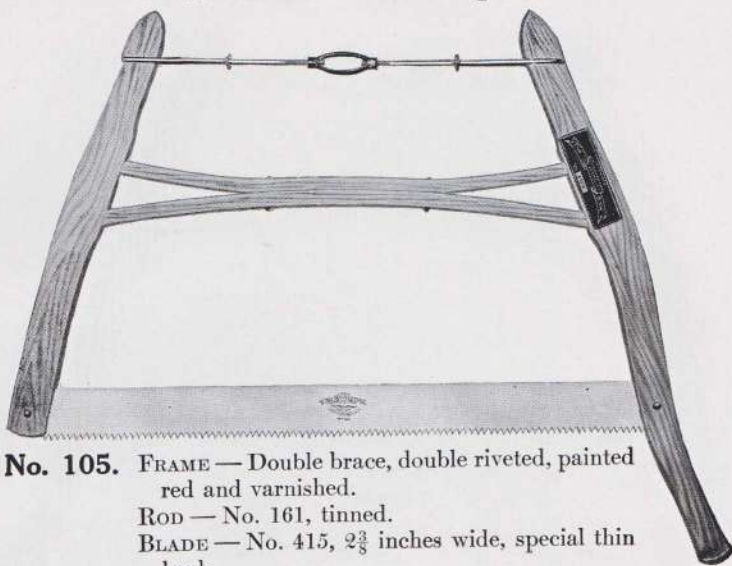

No. 105. FRAME — Double brace, double riveted, painted red and varnished.

ROD — No. 161, tinned.

BLADE — No. 415, $2\frac{3}{8}$ inches wide, special thin back.

With 30 inch blades	per dozen
With 32 inch blades	per dozen

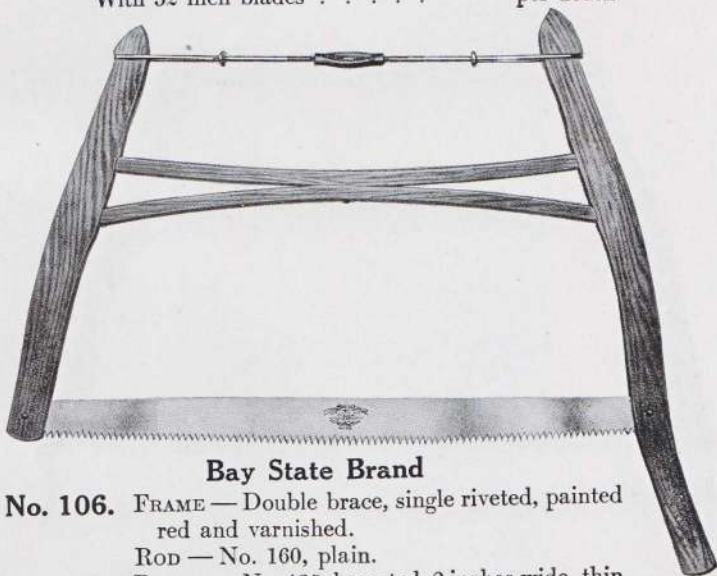

Bay State Brand

No. 106. FRAME — Double brace, single riveted, painted red and varnished.

ROD — No. 160, plain.

BLADE — No. 435, breasted, 2 inches wide, thin back.

With 30 inch blades	per dozen
With 32 inch blades	per dozen

For combinations of above frames with other rods or blades use separate list prices on frames, rods, and blades. Wood Saws packed one-half dozen in box.

See Discount Sheet for Prices

Wood Saws Complete

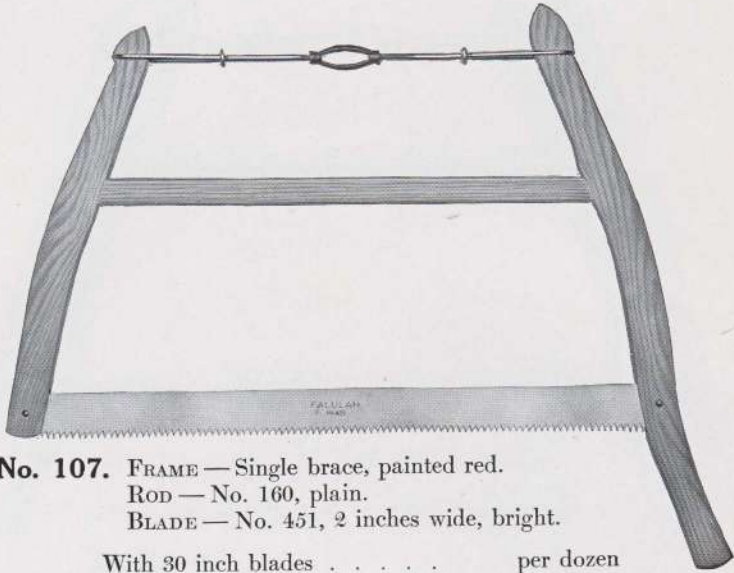

No. 107. FRAME — Single brace, painted red.
 ROD — No. 160, plain.
 BLADE — No. 451, 2 inches wide, bright.

With 30 inch blades	per dozen
With 32 inch blades	per dozen

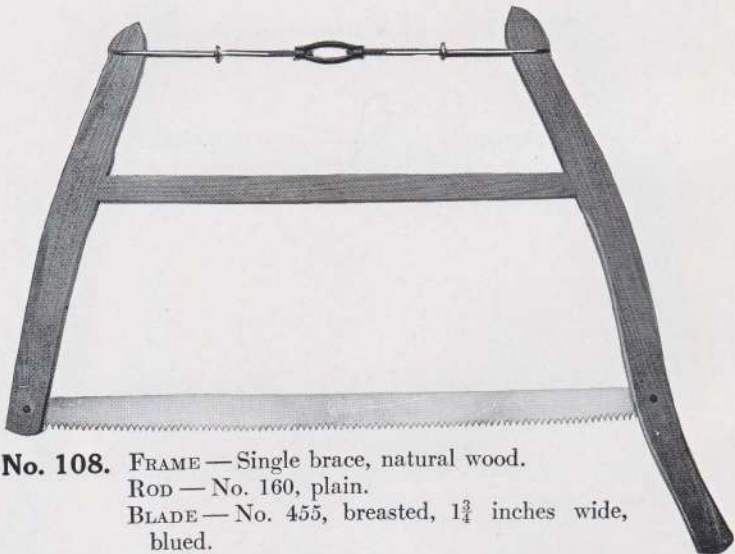

No. 108. FRAME — Single brace, natural wood.
 ROD — No. 160, plain.
 BLADE — No. 455, breasted, 1 $\frac{3}{4}$ inches wide, blued.

With 30 inch blades	per dozen
With 32 inch blades	per dozen

For combinations of above frames with other rods or blades use separate list prices on frames, rods, and blades. Wood Saws packed one-half dozen in box.

See Discount Sheet for Prices

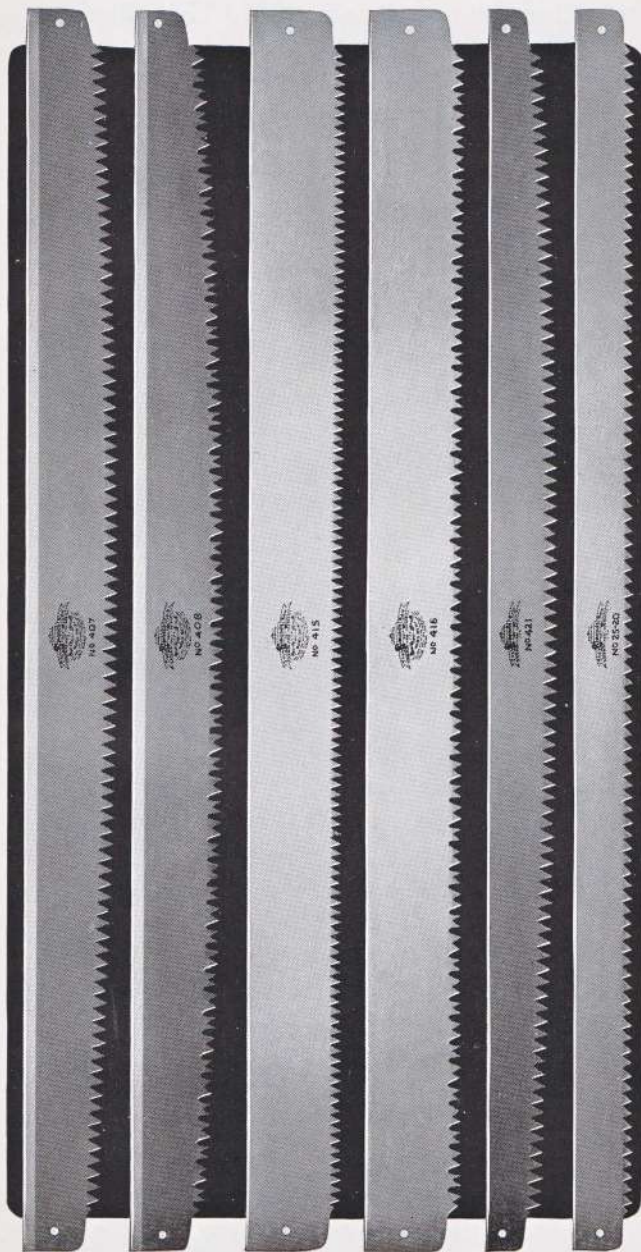

Simonds Wood Saw Blades

Made of Simonds Steel

Extra Thin Back

Special Finish

- No. 407. Plain tooth, blued blade, breastst. 2 1/4 inches wide. Ground 4 gauges taper.
 No. 408. Champion tooth, blued blade, breastst. 2 1/4 inches wide. Ground 4 gauges taper.
 No. 415. Plain tooth, bright blade, straight. 2 3/8 inches wide. Ground 3 gauges taper.
 No. 416. Champion tooth, bright blade, straight. 2 3/8 inches wide. Ground 3 gauges taper.
 No. 421. Plain tooth, blued blade, breastst. 1 3/4 inches wide. Ground 3 gauges taper.
 No. 25-20. Plain tooth, straw colored blade, straight, 1 3/8 inches wide. Ground 3 gauges taper.

All above blades made in 30 and 32 inch lengths. See Discount Sheet for Prices

Wood Saw Blades

Etched Bay State Saw Manufacturing Co. Thin Back

- No. 431. Plain tooth, bright blade, breasted. $2\frac{1}{4}$ inches wide. Ground 2 gauges taper.
 No. 432. Champion tooth, bright blade, breasted. $2\frac{1}{4}$ inches wide. Ground 2 gauges taper.
 No. 435. Plain tooth, bright blade, breasted. 2 inches wide. Ground 2 gauges taper.
 No. 436. Champion tooth, blued blade, breasted. 2 inches wide. Ground 2 gauges taper.
 No. 439. Plain tooth, blued blade, breasted. $1\frac{3}{4}$ inches wide. Ground 2 gauges taper.

Crucible Steel. Flat Ground

- No. 451. Plain tooth, bright blade, straight. 2 inches wide.
 No. 452. Champion tooth, bright blade, straight. 2 inches wide.
 No. 453. Plain tooth, bright blade, breasted. 2 inches wide.
 No. 455. Plain tooth, blued blade, breasted. $1\frac{3}{4}$ inches wide.

All above Blades made in 30 and 32 inch lengths

Rods for Wood Saw Frames



- No. 160. Swivel Loop Rod, Plain. 21, 22 or 24 inch.
 No. 161. Swivel Loop Rod, Tinned. 21, 22 or 24 inch.



- No. 163. Simonds Extra Heavy Rod, Tinned. 21, 22, or 24 inch.

Simonds Wood Saw Frames Without Blades or Rods

For styles and descriptions of frames, see Framed Wood Saws on preceding pages.

No. 0120
 No. 0103

No. 0104
 No. 0105
 No. 0108

No. 0106
 No. 0107

See Discount Sheet for Prices

Why it Pays to Use SIMONDS Special CROSS-CUT FILES

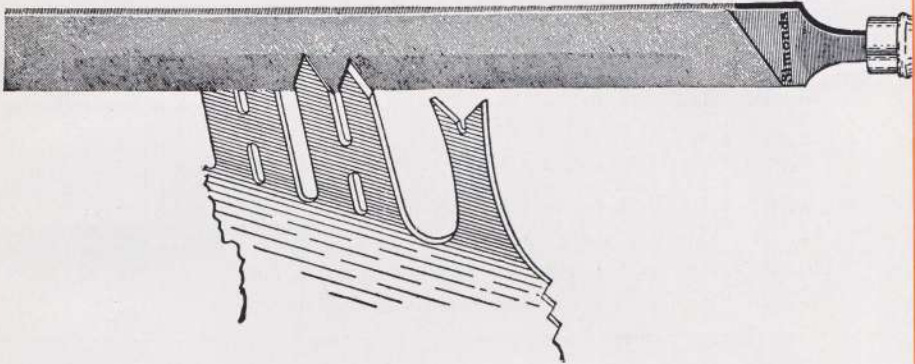

The Simonds Special Cross-Cut File will give 16 per cent more wear on Cross-Cut Saw work than can be obtained in using the regular taper file.

In using a common Mill File (the shape of which is tapered at the point) for filing cross-cuts, the tapered portion of the file is not wide enough to use both halves of one side without the saw teeth crossing the center line of the file. Consequently, at the point of the teeth there is a certain portion of the file that is required to do double duty. Now, by using the Simonds Special Cross-Cut File, because it is uniform in width, the same amount of perfect work is secured from each half of each side, an amount that will average at least 16 per cent more work than can be secured with a regular shaped Mill File.

That's why it pays to use the Simonds File.

16 per cent is a conservative estimate.

The shadow on the file in the illustration shows the file teeth that do the work. This line does not extend beyond the middle of the file. Turn the file over, use the other half, and you nearly double its value.

Clearly, you get two full sets of cutting teeth on the Simonds Special Cross-Cut File.

This File is sold by Hardware and Supply Dealers everywhere.

List Price	{	6 inch	\$4.60 per dozen
		7 "	4.90 " "
		8 "	5.80 " "
		10 "	7.80 " "

Write for Discounts

Files and Rasps

Manufactured by

SIMONDS FILE COMPANY, FITCHBURG, MASS., U. S. A.

Revised and Reprinted Jan. 1, 1919.

LIST PRICE PER DOZEN

INCH	MILL			MILL 1 R. E.		MILL 2 R. E.		MILL BLUNT		Square Blunt Bast.	Round Blunt Bast.
	Bast.	2d Cut	Smooth	Bast.	2d Cut	Bast.	2d Cut	Bast.	2d Cut		
4	3.00
5	3.20
6	3.50	4.00	4.50	3.90	4.50	4.40	5.00	3.90	4.60	5.50
7	3.90	4.60	4.90	4.40	5.20	4.90	5.80	4.30	4.90
8	4.30	4.90	5.40	4.80	5.50	5.40	6.10	4.90	5.80	7.40	5.60
9	4.90	5.80	6.30	5.50	6.50	6.10	7.30	5.60	6.40
10	5.60	6.40	7.00	6.30	7.20	7.00	8.00	6.70	7.80	10.20	7.50
12	7.50	8.60	9.40	8.40	9.70	9.40	10.80	9.40	10.70	13.90	10.70
14	10.70	12.20	13.10	12.00	13.70	13.40	15.30	18.70	14.70
16	14.70	16.80	17.90	25.10
18	20.20	32.80

INCH	FLAT			HAND			PILLAR			Flat Sgl. Cut, Coarse and Bast.
	Bast.	2d Cut	Smooth	Bast.	2d Cut	Smooth	Bast.	2d Cut	Smooth	
4	3.70	4.30	4.70	3.70	4.30	4.80
5	3.90	4.60	4.90	3.90	4.70	5.30
6	4.30	4.80	5.30	4.30	5.10	5.60	4.30	5.10	5.60
7	4.80	5.50	6.10	4.90	5.80	6.30
8	5.30	6.10	6.60	5.40	6.30	6.70	5.40	6.30	6.70	6.30
9	6.30	7.20	7.90	6.70	7.80	8.30
10	7.00	8.10	8.70	7.50	8.70	9.40	7.50	8.70	9.40	8.60
11	8.60
12	9.70	11.00	12.10	10.70	12.30	13.50	10.70	12.30	13.50	11.80
13	11.80
14	13.30	15.30	16.70	15.00	17.00	18.20	15.00	17.00	18.20	16.00
16	17.80	20.10	22.30	20.10	22.80	24.20	20.10	22.80	24.20
18	23.90	26.80	29.20	26.80	29.90	31.50

INCH	ROUND			SQUARE			HALF ROUND			THREE SQUARE		
	Bast.	2d Cut	Smooth	Bast.	2d Cut	Smooth	Bast.	2d Cut	Smooth	Bast.	2d Cut	Smooth
4	3.00	3.50	3.90	3.80	4.60	4.90	4.80	5.60	6.10	4.80	5.60	6.10
5	3.20	3.80	4.10	4.10	4.80	5.30	5.40	6.10	6.40	5.40	6.10	6.40
6	3.50	4.00	4.50	4.60	5.10	5.50	6.10	6.70	7.10	6.10	6.70	7.10
7	3.90	4.60	4.90	5.10	5.80	6.30	7.00	7.70	8.20	7.00	7.70	8.20
8	4.30	4.90	5.40	5.50	6.30	7.00	7.50	8.30	8.90	7.50	8.30	8.90
9	4.90	5.80	6.30
10	5.60	6.40	7.00	7.40	8.50	9.10	9.10	10.10	10.70	9.10	10.10	10.70
12	7.50	8.60	9.40	10.20	11.50	12.80	11.80	13.00	13.90	11.80	13.00	13.90
14	10.70	12.20	13.10	13.90	16.10	17.50	15.50	17.00	18.30	15.50	17.00	18.30
16	14.70	16.80	17.90	18.70	21.20	23.30	20.60	22.50	24.20	20.60	22.50	24.20
18	20.20	22.70	24.30	25.10	28.20	30.40	27.50	29.90	32.00	27.50	29.90	32.00

SIMONDS—"THE SAW MAKERS"

Simonds Files and Rasps—Continued

Revised and Reprinted Jan. 1, 1919.

LIST PRICE PER DOZEN

INCH	TAPERS		Hand-Saw Blunt	Slim Taper	Extra Slim Taper	BANDSAW BLUNT & TAPER		Double Ender	Plt Saw	Special Hand Saw	Special Cross-Cut Saw
	Sgl. Cut	Dbl. Cut				Regular	Slim				
3	2.10	2.50	2.10
3½	2.10	2.50	2.10
4	2.20	2.90	2.60	2.20	2.20	2.90	4.80
4½	2.40	3.10	3.00	2.30	2.30	3.10	5.40
5	2.60	3.50	3.40	2.50	2.50	3.50	5.40	3.10
5½	3.00	2.90	2.90	6.10	3.80
6	3.40	4.70	4.30	3.10	3.10	4.70	3.90	6.10	4.50	4.60
7	4.30	5.60	5.40	3.80	3.80	5.60	3.50	7.00	4.90
8	5.40	6.70	6.60	4.50	4.50	6.70	5.30	3.90	7.50	5.80
9	4.40
10	8.10	6.40	4.90	7.80
12	12.50	9.50

INCH	FLAT OPEN CUT			HALF ROUND OPEN CUT			HAND FINISHING		Flat Dead Smooth	Hand Dead Smooth	Half Rd. Dead Smooth
	Bast.	2d Cut	Smooth	Bast.	2d Cut	Smooth	2d Cut	Smooth			
6
7
8	6.30	7.20	7.90	8.50	9.40	9.90	7.80	8.30	10.60	10.80	15.00
9
10	8.60	9.80	10.70	10.70	11.80	12.70	10.90	11.80	14.00	15.00	18.20
12	11.80	13.60	14.70	14.10	15.40	16.60	15.20	16.20	19.40	21.40	23.60
14	16.00	18.30	20.00	18.50	20.40	21.70	20.60	21.70	26.60	30.00	31.00

INCH	WARDING			KNIFE			Planer Knife	Cant Saw	Cross Cut	Hook Tooth	Cabinet Files
	Bast.	2d Cut	Smooth	Bast.	2d Cut	Smooth					
4	4.00	4.80	5.40	5.40	6.10	6.40
5	4.50	5.30	5.80	6.10	6.70	7.10
6	4.90	5.90	6.40	6.90	7.50	7.90	5.40	8.10
8	6.40	7.50	8.20	8.50	9.10	9.50	6.40	6.40	7.50	8.30	10.10
10	8.70	10.10	11.00	10.10	11.50	12.30	8.60	8.70	9.10	10.10	13.70
12	13.70	15.20	16.10	18.70
14	24.80
16

INCH	LEAD FLOAT AND WOOD FILES		FLAT WOOD RASPS		HALF ROUND WOOD RASPS			CABINET RASPS		SHOE RASPS	HORSE RASPS	
	Flat	Hf. Rd.	Bast.	2d Cut	Bast.	2d Cut	Smooth	2d Cut	Smooth		Hf. Rd.	Plain ½ File
6	4.80	7.00	8.10	9.30	10.10	10.10	11.70
8	6.30	8.50	9.40	11.40	10.10	12.20	13.70	12.80	15.50	10.10
9	12.20
10	8.60	10.70	12.80	15.50	13.70	16.80	18.70	17.50	20.70	13.70
12	11.80	14.10	17.50	20.90	18.70	22.40	24.80	22.80	26.80	12.80	16.80
13	19.60
14	16.00	18.50	23.20	27.80	24.80	29.70	32.90	29.60	33.90	17.80	23.10
15	20.90
16	21.50	24.70	30.80	36.20	32.90	38.90	43.60	24.40	32.20
18	32.90

The above list comprises all of the kinds, sizes, and cuts of files that will be regularly carried in stock. Any thing differing from these files will be considered as special and will not be manufactured except in cases of urgent necessity; and when manufactured, price will be based strictly upon cost of material and cost of manufacture at time goods are made.

Simonds Hack Saw Blades

Hard Edge Blades made in hand sizes only
 All Hard Blades in all sizes both hand and power
 Prices apply to both

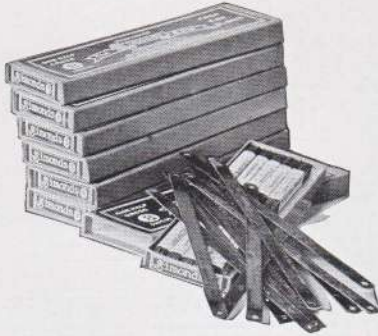

Simonds blades, because they cut with less resistance, remove no more metal than necessary, and outwear other makes, are the most economical Hack Saw Blades on the market.

The steel used in the Simonds Hack Saw is made and toughened by a Simonds process especially for hard cutting service. It is the basis on which this exceptionally high grade blade is built.

Price List

Simonds Hand Hack Saw Blades

Length	Width	Gauge	Teeth per Inch				Per Gross	No. in Box
			Regular	Medium	Fine	Extra Fine		
8 inches	$\frac{1}{2}$ inch	23 = .025	14	18	24	32	8.00	$\frac{1}{2}$ gross
9 "	$\frac{1}{2}$ "	23 = .025	14	18	24	32	9.00	$\frac{1}{2}$ "
10 "	$\frac{1}{2}$ "	23 = .025	14	18	24	32	10.00	$\frac{1}{2}$ "
11 "	$\frac{1}{2}$ "	23 = .025	14	18	24	32	11.00	$\frac{1}{2}$ "
12 "	$\frac{1}{2}$ "	23 = .025	14	18	24	32	12.00	$\frac{1}{2}$ "
14 "	$\frac{1}{2}$ "	23 = .025	14	18	24	32	14.80	$\frac{1}{2}$ "
16 "	$\frac{1}{2}$ "	23 = .025	14	18	24	32	17.00	$\frac{1}{2}$ "

Odd sizes, not listed, take price of next longer or wider size of same gauge.

Regular—for cutting soft steel, iron solids, and rails.

Medium—for cutting tool steel, iron pipe, hard metals, and light angle iron.

Fine—for cutting brass, copper, drill rod, medium tubing, and sheet metals.

Extra Fine—for cutting thin tubing and thin sheet metals.

Unless specified, "Regular" blades will be sent

Write for Discounts

SIMONDS—"THE SAW MAKERS"

Price List

Simonds Power Machine Hack Saw Blades

Length	Width	Gauge	Teeth per Inch		Per Gross	No. in Box
			Regular	Medium		
10 inches	$\frac{3}{4}$ inch	21 = .032	12 or 14	18	\$15.36	$\frac{1}{2}$ gross
10 "	"	21 = .032	12 or 14	18	18.24	"
12 "	"	21 = .032	12 or 14	18	17.88	"
12 "	"	21 = .032	12 or 14	18	21.36	"
14 "	"	21 = .032	12 or 14	18	24.36	"
17 "	"	21 = .032	12 or 14	18	29.04	"

Regular—for cutting solids in iron or steel, and for general shop saw work.

Medium—for cutting brass, castings, iron pipe, heavy tubing, etc.

We recommend (and unless otherwise specified, furnish on orders) power blades with 12 teeth, rather than 14 teeth, as they will cut faster and last longer.

Heavy Power Machine Blades

Length	Width	Gauge	Teeth per Inch			Per Gross	No. in Box
			Regular	Medium	Fine		
10 inches	$\frac{3}{4}$ inch	18 = .049	12* or 14	\$24.72	$\frac{1}{2}$ gross
10 $\frac{1}{4}$ "	$\frac{3}{4}$ "	18 = .049	9	25.08	"
12 "	$\frac{3}{4}$ "	18 = .049	9 or 12*	14	18	28.92	"
12 "	1 "	18 = .049	9* or 12	14	18	37.92	"
14 "	$\frac{3}{4}$ "	18 = .049	9 or 12*	14	18	33.12	"
14 "	1 "	18 = .049	9* or 12	14	18	43.56	"
14 "	1 $\frac{1}{8}$ "	18 = .049	9	53.52	"
14 "	1 "	16 = .065	9* or 12	50.88	"
17 "	$\frac{3}{4}$ "	18 = .049	9 or 12*	14	..	39.72	"
17 "	1 "	18 = .049	9 or 12*	14	..	51.72	"
17 "	1 $\frac{1}{4}$ "	18 = .049	9	63.36	"
17 "	1 "	16 = .065	9* or 12	59.52	"
18 "	1 "	18 = .049	9 or 12*	54.36	"
18 "	1 "	16 = .065	9* or 12	62.04	"
20 "	1 "	18 = .049	9 or 12*	59.52	"
20 "	1 "	16 = .065	9	67.92	"
24 "	1 "	18 = .049	9* or 12	70.32	"
24 "	1 "	16 = .065	9	79.32	"
24 "	1 $\frac{1}{2}$ "	16 = .065	9	119.04	"
30 "	1 $\frac{1}{2}$ "	16 = .065	9	147.84	"

*This number of teeth furnished unless the optional number is specified.

14-inch and 17-inch power blades measure 13 $\frac{1}{2}$ inches and 16 $\frac{1}{2}$ inches between centres of holes respectively. All other power blades measure from centre to centre of holes.

Odd sizes, not listed, take price of next longer or wider size of same gauge.

Unless specified, "Regular" blades will be sent

Write for Discounts

The "Culley" Flexible Hack Saw Blades No. 31

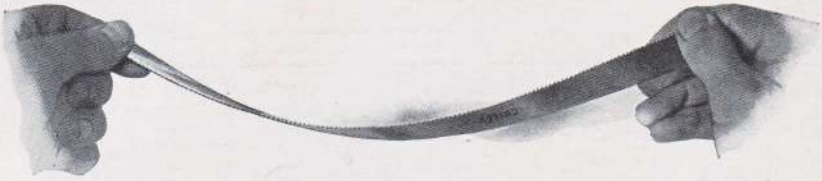

For plumbers, electricians, bicycle manufacturers and repairers, etc. Used principally for cutting brass, tubing, stringy metals. *Not intended for use on Cast Steel, or such hard metals.* They will not break or shell teeth. *For hand use only.*

MADE IN THE FOLLOWING SIZES

Length	Per Dozen	Per Gross
8 inch	\$0.70	\$8.00
9 "	.75	9.00
10 "	.85	10.00
12 "	1.00	12.00

NOTE.— Regular blades have 16 teeth per inch. Fine blades (for tubing) have 24 teeth per inch. For very thin tubing or very thin sheet metal use blades with 30 teeth per inch. Care should be taken to select blades with the proper number of teeth for the material to be cut.

SIMONDS HARD EDGE HACK SAW

14 18 24 32

SIMONDS
NON-BREAKING
HARD EDGE
HACK SAWS

FOR MACHINISTS
AND PLUMBERS

For general use we recommend Hard Edge Blades—18 teeth to the inch Practically unbreakable. Shelling of teeth reduced to a minimum

Select the Best Blade for the kind of material you want to cut

Retail Dealers selling our Non-breaking Hard Edge Hack Saw Blades should display one of these sales-making cards. There are on each card sample blades with 14, 18, 24, and 32 teeth per inch, and a note by each style blade explains the cutting for which it is best adapted. This is the most practical store card ever offered by a Hack Saw Manufacturer. Size, 9 inches wide, 11 inches high. One sent free to any Dealer selling Simonds Hack Saws. Address, Advertising Dept., Simonds Manufacturing Company, Fitchburg, Mass.

Simonds Screw Slotting Blades

For Cutting Slots in Screw Heads



A Screw Slotter Blade in a Simonds Adjustable Hack Saw Frame. Note completed slots on different size screw heads.



The sections of the Simonds Screw Slotter Blade shown here illustrate the shape and size of the teeth and the shape of the blade—thick at the tooth edge and concave, making it much thinner at the back. This good clearance prevents binding and makes the blade cut easily.



FOR MACHINE SHOPS. It's a remarkably handy tool. Cutting wide slots in screw heads is only one of many uses to which the Simonds Screw Slotting Blade may be put. Covers a wide range of odd job work. A necessity in every shop. Used like a hack saw blade, and will fit any frame that takes an 8-inch blade. For hand use only. Four 8-inch long blades of same width but different thicknesses to a set. Milled teeth, 14 and 24 to the inch. Unless specified, blades with 14 teeth will be sent.

LIST PRICES

Width	Size		8-Inch		Shipping Weight Per Doz.
	Thickness		Gross	Dozen	
1/2 inch	.109 x	.080			17 oz.
1/2 inch	.083 x	.065			14 oz.
1/2 inch	.065 x	.052			11 oz.
1/2 inch	.049 x	.039			9 oz.

Sample set, four different sizes, 8-inch blades

See Discount Sheet for Prices

Hack Saw Frames

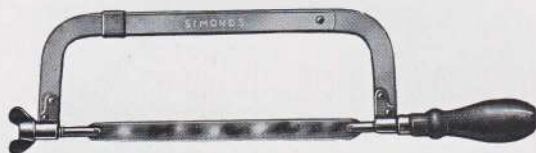

No. 37. Nickel Plated. Adjustable for blades 8 to 12 inches
Blades can be faced in four directions
Packed one in a box

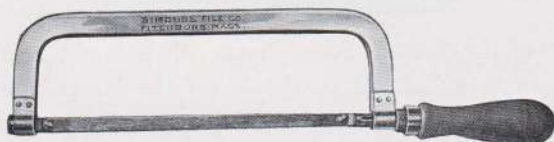

No. 20. Nickel Plated. Blade can be faced in four directions
8 inch Frames
Packed one in a box



No. 40. Nickel Plated. Adjustable Extra Heavy Back.
Packed one in a box

See Discount Sheet for Prices

Simonds Straight Cut or "Pistol Grip" Hack Saw Frames

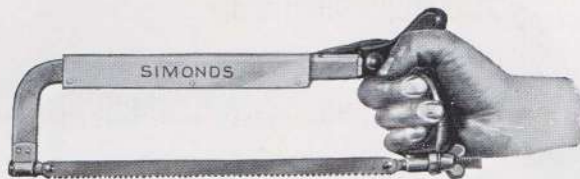

Pat. Feb. 11, 1908

No. 41. Nickel Plated. Heavy Back. Blades can be faced in four directions. Adjustable for blades 8 inches to 12 inches. Packed one in a box.

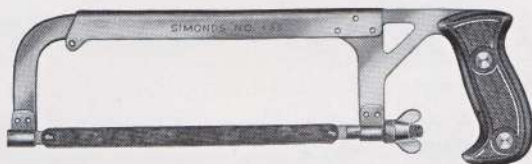

No. 135. Nickel Plated. Adjustable for blades 8 inches to 12 inches long. $2\frac{1}{2}$ inches from back of blade to inside of frame. Packed one in a box.

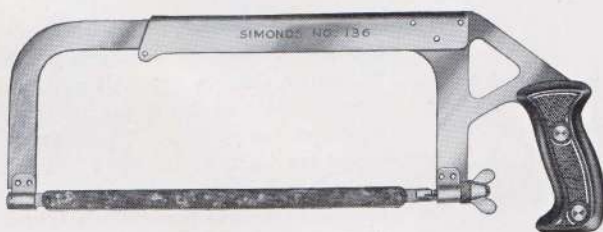

No. 136. Nickel Plated. Adjustable for blades from 8 inches to 12 inches long. Extra heavy back. 4 inches from back of blade to inside of frame. Packed one in a box.

The arrangement of the handle on frames Nos. 135 and 136 protects the hand of the operator from accident or injury caused by being jammed against the work in case of a blade breaking. (Use Simonds **HARD EDGE** Hack Saw Blades; they are practically unbreakable.)

See Discount Sheet for Prices

Rail Hack Saw Frames

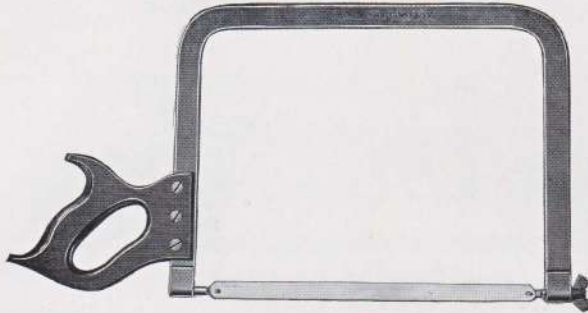

Forged Steel Frame, Nickel Plated, Drop Handle. Depth inside of frame to cutting edge of blades, 10 $\frac{1}{4}$ inches

- | | | |
|--------------------|------------------------------|-----------|
| No. 21. | For 12 inch blades | per dozen |
| No. 21 A. | For 14 inch blades | per dozen |
| * No. 21 B. | For 16 inch blades | per dozen |
| * No. 21 C. | For 18 inch blades | per dozen |

* Numbers 21B and 21C are made with a handle on each end of the frame.

Packed one in box

Simonds Thumb Grip for Hack Saw Frame

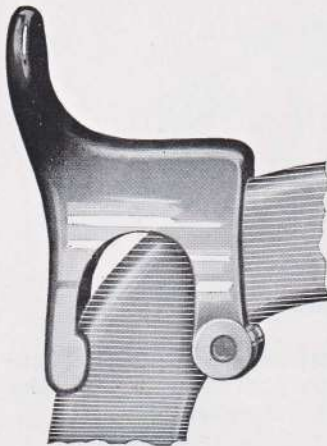

The Thumb Grip or Rest fits any standard Hack Saw frame. Without a suitable attachment there is no regular place to grip a Hack Saw frame on the forward end, and this is especially awkward for the thumb of the operator. The Simonds Thumb Grip causes the frame to feel easier in the hand, the grip, control, and pressure being more readily governed by the operator, thus permitting greater ease and accuracy with the work.

Nickel Plated Thumb Grips, List Price

- | | |
|---|--|
| No. 475, for regular size frames, 3-16" thick x 11-16" wide | |
| No. 476, for large size frames, 3-16" thick x 7-8" wide | |

See Discount Sheet for Prices

Simonds High Speed Steel Tool Holder Bits

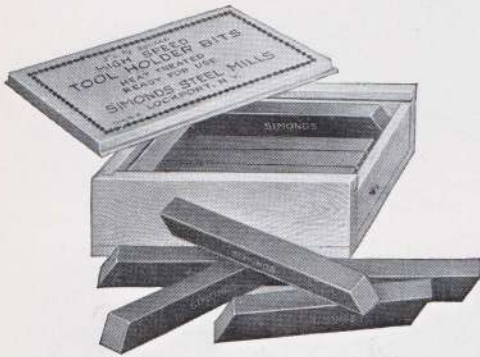

Simonds High Speed Steel Holder Bits cut faster and last longer than others, because they are made of Crucible Steel in which the full percentage of Tungsten, Chrome, and Vanadium is used, bringing a tool of this character to the highest efficiency. Great care is used, not only in the manufacture of the Crucible Steel, but also in the rolling temperatures and the heat treatment. Each piece is heat treated with particular care to bring out the utmost cutting properties.

These bits are cut to standard tool holder lengths with 30 degree bevel on each end. Finished straight and true to size, ready to be ground and put to work. Carried in stock in 5 lb. and 10 lb. boxes, one size or assorted sizes in each box. Prices on application.

$\frac{1}{4}$ inch square x $2\frac{1}{2}$ inches long

$\frac{5}{16}$ inch square x $2\frac{1}{2}$ inches long

$\frac{3}{8}$ inch square x 3 inches long

$\frac{7}{16}$ inch square x $3\frac{1}{2}$ inches long

$\frac{1}{2}$ inch square x 4 inches long

$\frac{5}{8}$ inch square x $4\frac{1}{2}$ inches long

$\frac{3}{4}$ inch square x $4\frac{1}{2}$ inches long

Simonds Flat Ground Stock

Thickness	Width						
	1	$1\frac{1}{2}$	2	$2\frac{1}{2}$	3	$3\frac{1}{2}$	4
$\frac{1}{64}$			1.25	1.55	1.85	2.15	2.50
$\frac{1}{32}$			1.00	1.25	1.50	1.75	2.00
$\frac{1}{16}$.50	.70	.90	1.10	1.35	1.60	1.85
$\frac{3}{32}$.55	.75	.95	1.15	1.40	1.65	1.90
$\frac{1}{8}$.60	.80	1.00	1.25	1.50	1.75	2.00
$\frac{5}{32}$.65	.90	1.15	1.40	1.70	2.00	2.30
$\frac{3}{16}$.70	1.00	1.30	1.60	1.90	2.30	2.60
$\frac{7}{32}$.80	1.15	1.50	1.85	2.20	2.60	3.00
$\frac{1}{4}$.90	1.30	1.70	2.15	2.60	3.05	3.50
$\frac{9}{32}$	1.00	1.45	1.90	2.35	2.90	3.35	4.00
$\frac{5}{16}$	1.10	1.60	2.10	2.60	3.20	3.80	4.50
$\frac{3}{8}$	1.30	1.80	2.40	3.05	3.60	4.40	5.00
$\frac{7}{16}$	1.50	2.05	2.75	3.50	4.25	5.00	5.75
$\frac{1}{2}$	1.70	2.50	3.25	4.10	5.00	5.90	6.90

Write for Discounts

Simonds Screw Slotters

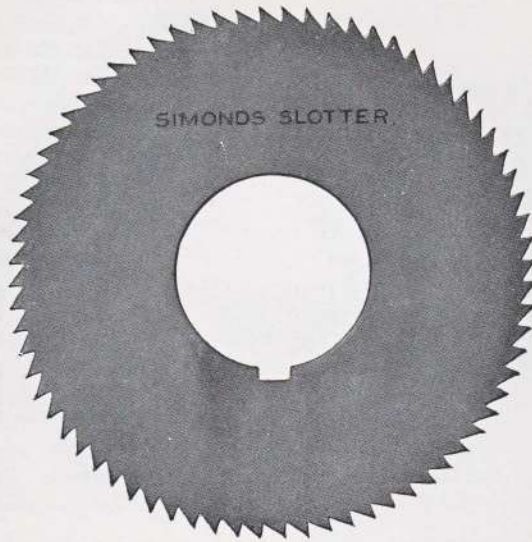

Screw Slotters are used mostly for cutting slots in screw heads, and are made with fine teeth for the reason that the heads on screws vary from $\frac{1}{16}$ inch to 1 inch in diameter. They are made with fine teeth to prevent shelling of teeth which might occur if the space between the teeth was more than the diameter of small screw heads, such as $\frac{1}{16}$ inch.

Teeth are milled to the center and brought up to a sharp cutting edge. All teeth have the same shape, about 62 degrees.

Carbon Steel Screw Slotters are not ground for clearance on the sides, but are left flat because they do not cut any deeper than $\frac{1}{16}$ inch below the bottom of the tooth. They should not be used under any circumstances as a Slitter.

High Speed Steel Slotters are ground flat on the sides.

What information should be given when sending in an order for Screw Slotters? Quantity, diameter, thickness in thousandths, size of hole, and number of teeth. Unless number of teeth is specified we would furnish the number shown in the schedule. State whether High Speed Steel or Carbon Steel is wanted. We put a standard keyway in every Screw Slotter.

High Speed Steel Screw Slotter

List Prices

Diameter	Thickness	Price	Diameter	Thickness	Price
$2\frac{3}{4}$.162	2.75	$2\frac{3}{4}$.057	1.10
$2\frac{3}{4}$.144	2.50	$2\frac{3}{4}$.057	1.10
$2\frac{3}{4}$.128	2.25	$2\frac{3}{4}$.045	1.00
$2\frac{3}{4}$.114	2.00	$2\frac{3}{4}$.040	1.00
$2\frac{3}{4}$.102	1.80	$2\frac{3}{4}$.035	1.00
$2\frac{3}{4}$.091	1.60	$2\frac{3}{4}$.032	1.00
$2\frac{3}{4}$.081	1.40	$2\frac{3}{4}$.028	1.00
$2\frac{3}{4}$.072	1.30	$2\frac{3}{4}$.025	1.00
$2\frac{3}{4}$.064	1.20	$2\frac{3}{4}$.023	1.00
			$2\frac{3}{4}$.020	1.00

Write for Discounts

Simonds Screw Slotting Cutters For Slotting Screw Heads and Similar Work

These Cutters are not ground on the sides

2³/₄" standard cutters have 72 teeth
 2¹/₂" " " " " 60 "
 1³/₄" " " " " 90 "

LIST PRICE

Diameter	Thickness in Decimals	Size of Hole	Price Each Carbon	Diameter	Thickness in Decimals	Size of Hole	Price Each Carbon
2 ³ / ₄ "	.182	1	\$0.90	2 ¹ / ₄ "	.045	5	\$0.20
2 ³ / ₄ "	.162	1	.75	2 ¹ / ₄ "	.040	5	.20
2 ³ / ₄ "	.144	1	.65	2 ¹ / ₄ "	.035	5	.20
2 ³ / ₄ "	.128	3/4	.55	2 ¹ / ₄ "	.032	1/2, 5/8, 3/4	.20
2 ³ / ₄ "	.114	3/4	.50	2 ¹ / ₄ "	.028	5/8, 3/4, 7/8	.20
2 ³ / ₄ "	.102	3/4	.45	2 ¹ / ₄ "	.025	1/2, 5/8, 3/4	.20
2 ³ / ₄ "	.091	3/4	.40	2 ¹ / ₄ "	.023	1/2, 5/8, 3/4	.20
2 ³ / ₄ "	.081	3/4	.35	2 ¹ / ₄ "	.020	1/2, 5/8, 3/4	.20
2 ³ / ₄ "	.072	3/4	.30	2 ¹ / ₄ "	.018	1/2, 5/8, 3/4	.20
2 ³ / ₄ "	.064	1/2, 5/8, 3/4, 7/8	.30	2 ¹ / ₄ "	.016	1/2, 5/8, 3/4	.20
2 ³ / ₄ "	.057	5/8, 3/4, 7/8	.20	2 ¹ / ₄ "	.014	5/8, 3/4, 7/8	.20
2 ³ / ₄ "	.051	1/2, 5/8, 3/4, 7/8	.20	2 ¹ / ₄ "	.012	1/2, 5/8, 3/4	.20
2 ³ / ₄ "	.045	5/8, 3/4, 7/8	.20	2 ¹ / ₄ "	.010	1/2, 5/8, 3/4	.20
2 ³ / ₄ "	.040	5/8, 3/4, 7/8	.20	2 ¹ / ₄ "	.008	5/8, 3/4, 7/8	.20
2 ³ / ₄ "	.035	1/2, 5/8, 3/4, 7/8	.20	2 ¹ / ₄ "	.006	1/2, 5/8, 3/4	.20
2 ³ / ₄ "	.032	1/2, 5/8, 3/4, 7/8	.20	1 ³ / ₄ "	.064	5	.20
2 ³ / ₄ "	.028	1/2, 5/8, 3/4, 7/8	.20	1 ³ / ₄ "	.057	5	.20
2 ³ / ₄ "	.025	1/2, 5/8, 3/4, 7/8	.20	1 ³ / ₄ "	.051	5	.20
2 ³ / ₄ "	.023	1/2, 5/8, 3/4, 7/8	.20	1 ³ / ₄ "	.045	5	.20
2 ³ / ₄ "	.020	1/2, 5/8, 3/4, 7/8	.20	1 ³ / ₄ "	.040	5	.20
2 ³ / ₄ "	.018	1/2, 5/8, 3/4, 7/8	.20	1 ³ / ₄ "	.035	5	.20
2 ³ / ₄ "	.016	1/2, 5/8, 3/4, 7/8	.20	1 ³ / ₄ "	.032	5	.20
2 ³ / ₄ "	.014	1/2, 5/8, 3/4, 7/8	.20	1 ³ / ₄ "	.028	5	.20
2 ³ / ₄ "	.012	1/2, 5/8, 3/4, 7/8	.20	1 ³ / ₄ "	.025	5	.20
2 ³ / ₄ "	.010	1/2, 5/8, 3/4, 7/8	.20	1 ³ / ₄ "	.023	5	.20
2 ³ / ₄ "	.008	1/2, 5/8, 3/4, 7/8	.20	1 ³ / ₄ "	.020	5	.15
2 ³ / ₄ "	.006	1/2, 5/8, 3/4, 7/8	.20	1 ³ / ₄ "	.018	5	.15
2 ¹ / ₄ "	.102	5	.40	1 ³ / ₄ "	.016	5	.15
2 ¹ / ₄ "	.091	5	.35	1 ³ / ₄ "	.014	5	.15
2 ¹ / ₄ "	.081	5	.30	1 ³ / ₄ "	.012	5	.15
2 ¹ / ₄ "	.072	5	.20	1 ³ / ₄ "	.010	5	.15
2 ¹ / ₄ "	.064	5	.20	1 ³ / ₄ "	.008	5	.15
2 ¹ / ₄ "	.057	5	.20	1 ³ / ₄ "	.006	5	.15
2 ¹ / ₄ "	.051	5	.20				

Cutters of other than standard dimensions are made to order.
 All cutters are furnished with standard keyway.

Simonds Metal Slitting Saws

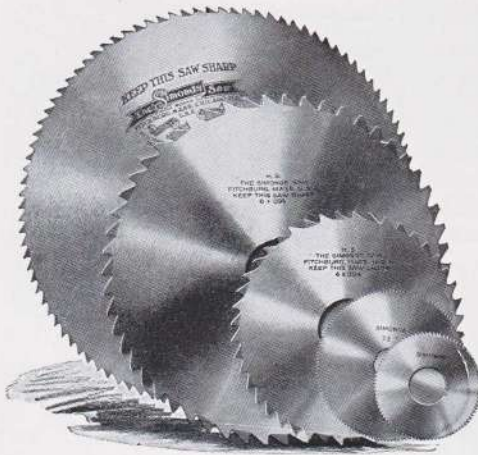

Metal Slitting Saws are used mostly for making slits of a specified size. They are also used as a universal saw in machine shops for doing various kinds of small cutting-off work, this work being on all kinds of steel. A Screw Slotter makes a shallow slot; a Slitting Saw makes a deeper slot or slit or cuts off the metal entirely.

Teeth — Number of. Metal Slitting Saws have teeth ranging about as follows:

2 1/2" — 28 teeth	6" — 42 teeth
3" — 32 "	7" — 44 "
4" — 36 "	8" — 46 "
5" — 40 "	

The number of teeth in many cases is definitely specified by the customer, and this may vary from the above figures.

Teeth — Form of. The tooth in Metal Slitting Saws is what is known as the "square tooth" or "pitched to the center." It is backed off from 5 to 7 degrees on top for clearance. Also in other cases the back clearance is sometimes found to be at least 20 degrees, which is too much to offer sufficient backing to the cutting edge.

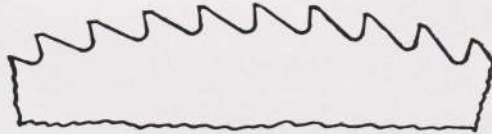

REGULAR BACKED OFF TOOTH



"V" TOOTH on small saws with less than 1/8" space

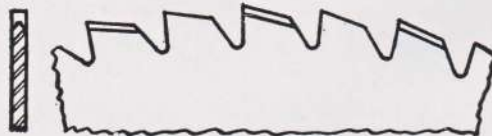

COPPER SLITTING TOOTH — each alternate tooth is "V" shape on top

Grinding. Slitting Saws are slightly concave ground for clearance. That is just enough to enable them to clear themselves and to prevent noticeably altering the thickness of the slitter as it wears down.

What Information Should Be Given When Sending in an Order for Metal Slitting Saws. Quantity, diameter, thickness in thousandths, size of hole, size of keyway if not standard, number of teeth, and kind of metal to be cut. Also say whether the Slitter is to be used as a slitting or as a cut-off saw, and whether it is to be used for general cutting purposes only, or for one line of work only, such as manufacturing some specified article.

Simonds Metal Slitting Saws

List Prices

Diameter Inches	Thickness Inches	Size Hole	Carbon Steel	Semi-High Speed	High Speed Steel
2 $\frac{1}{2}$	1/32	$\frac{7}{8}$	\$1.30	For Prices on Semi-High Speed Steel Slitters advance Carbon List 25%	\$2.50
2 $\frac{1}{2}$	3/64	$\frac{7}{8}$	1.20		2.40
2 $\frac{1}{2}$	1/16	$\frac{7}{8}$	1.15		2.35
2 $\frac{1}{2}$	3/32	$\frac{7}{8}$	1.15		2.35
2 $\frac{1}{2}$	1/8	$\frac{7}{8}$	1.15		2.35
2 $\frac{1}{2}$	5/32	$\frac{7}{8}$	1.40		2.60
3	1/32	1	1.60		2.95
3	3/64	1	1.45		2.60
3	1/16	1	1.30		2.50
3	3/32	1	1.30		2.50
3	1/8	1	1.30		2.50
3	5/32	1	1.50		2.85
4	1/32	1	2.85		4.60
4	3/64	1	1.85		3.15
4	1/16	1	1.60		2.95
4	3/32	1	1.55		2.85
4	1/8	1	1.55		2.85
4	5/32	1	1.80		3.45
4	3/16	1	2.10		3.45
5	1/16	1	2.30		3.85
5	3/32	1	2.00		3.35
5	1/8	1, 1 $\frac{1}{4}$, 1 $\frac{1}{2}$	2.00		3.35
5	5/32	1	2.45		4.30
5	3/16	1	2.90		4.30
6	1/16	1	5.10	7.50	
6	3/32	1	3.85	5.85	
6	1/8	1, 1 $\frac{1}{4}$	3.45	5.35	
6	3/16	1, 1 $\frac{1}{2}$	4.45	6.45	
7	1/16	1	9.50	11.00	
7	3/32	1	5.70	8.35	
7	1/8	1	4.85	7.20	
7	3/16	1 $\frac{1}{4}$, 2	6.50	9.05	
8	1/8	1, 1 $\frac{1}{4}$	7.30	12.00	
8	3/16	1 $\frac{1}{4}$, 1 $\frac{1}{2}$	8.90	12.30	

Above are Standard Sizes. Prices will be quoted on Slitting Saws of different specifications on receipt of Specifications and information as to quantity wanted.

Standard Keyways for Slitting Saws

Diameter of Hole	Width of Keyway	Depth of Keyway	Diameter of Hole	Width of Keyway	Depth of Keyway
3/8" to 9/16"	3/32	3/64	1 3/16" to 1 3/8"	3/16	3/32
5/8" to 7/8"	1/8	1/16	1 7/16" to 1 3/4"	1/4	1/8
1 5/16" to 1 1/8"	5/32	5/64	1 13/16" to 2"	5/16	5/32

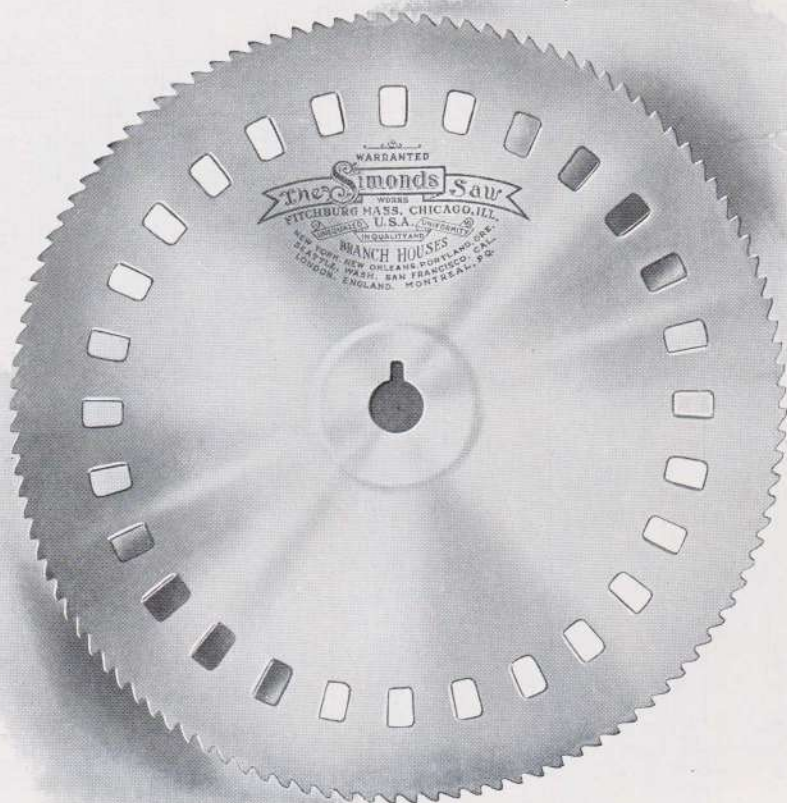

Simonds Metal Cutting Circular Saws
For Higley Machines

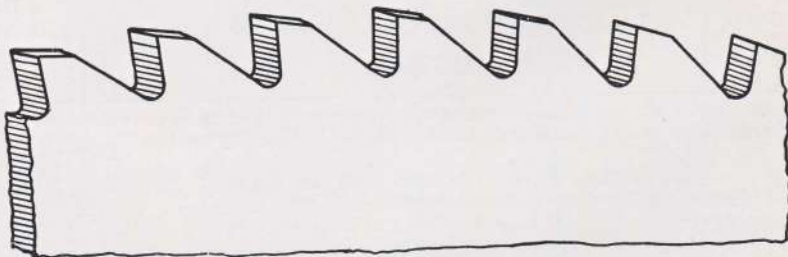

TOOTH STYLE. FIG. 1.

Great care is used to grind saws to exact micrometer measurements for clearance, and to properly form all teeth, slots, pin holes, and arbor holes.

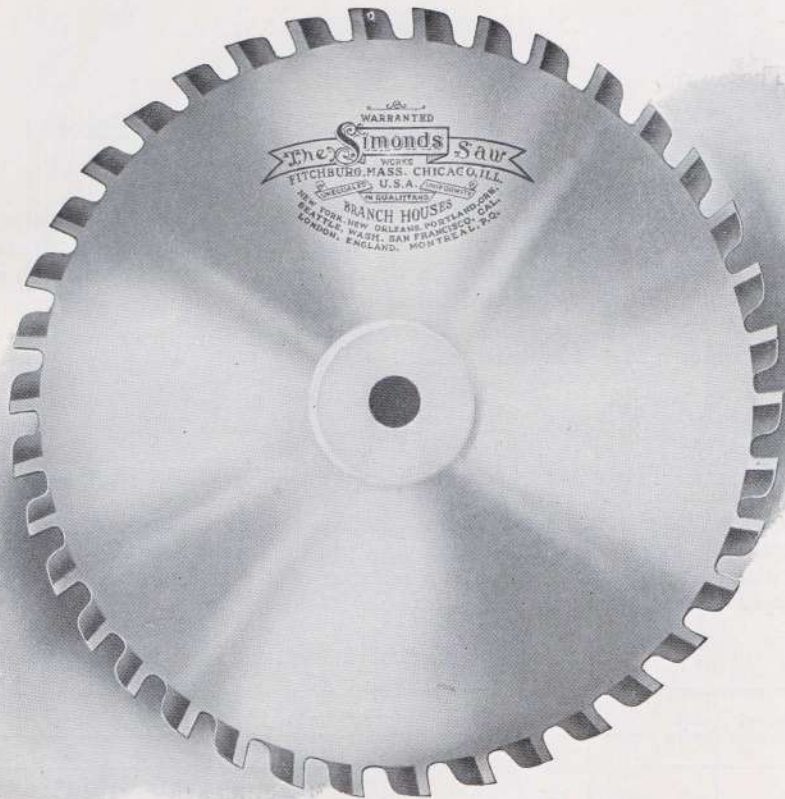

Simonds Metal Cutting Circular Saws

For Q & C Bryant Machines

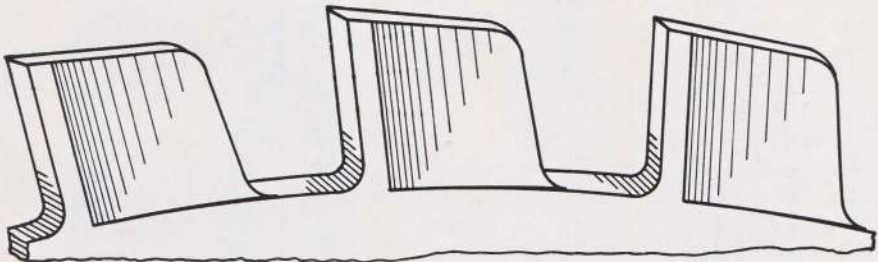

TOOTH STYLE. FIG. 2 (Q & C Bryant)

The backs of the teeth of the above saws are ground for clearance and to fit the cogs which engage them. These saws are taper ground, but at the centre are strengthened by being practically the same thickness as at the rim.

Simonds Metal Saws

These saws are made in three grades:

Carbon Steel **Semi-High Speed Steel**
High Speed Steel

We especially recommend the semi-high speed steel saw because it represents a steel vastly superior in cutting quality to the ordinary steels formerly used. This steel has been developed by exhaustive research and experiment in our own crucible steel mill. The advantage gained from using Simonds Saw Steel is a cutting power which allows of longer runs or of a faster feed — frequently both.

When Ordering Metal Saws

Please state material to be cut, make of machine, maker's catalogue number, diameter and thickness of blade, centre hole, pin holes and size of collars, also either the number of teeth in saw or the space from point to point. A rubbing of centre hole and pin holes is usually best. If your sharpener uses an index plate the number of teeth should be stated in place of the distance point to point.

Number of Teeth in Metal Saws

Standard Thickness	Dia. Inches	NUMBER AND PITCH OF TEETH													
		$\frac{1}{8}$	$\frac{1}{16}$	$\frac{1}{4}$	$\frac{3}{16}$	$\frac{1}{2}$	$\frac{7}{16}$	$\frac{3}{4}$	$\frac{15}{16}$	$\frac{1}{2}$	$\frac{3}{4}$				
$\frac{1}{16}$	8	200	134	100											
$\frac{1}{16}$	9	224	150	112											
$\frac{1}{16}$	10	250	168	124	100	84									
$\frac{3}{32}$	12		200	150	120										
$\frac{1}{8}$	13			162	130	108									
$\frac{1}{8}$	14			174	140	116	100	88							
$\frac{5}{32}$	15				150	124	108								
$\frac{9}{64}$	16				160	134	114	100							
$\frac{5}{32}$	18					150	130	112							
$\frac{9}{16}$	20					168	144	124	112						
$\frac{1}{8}$	22					184	158	138	122	110					
$\frac{13}{64}$	24					200	172	150	134	120					
$\frac{7}{32}$	26					218	186	162	144	130					
$\frac{7}{32}$	28					234	200	176	156	140					
$\frac{7}{32}$	30					250	214	188	168	150					
$\frac{1}{4}$	32					268	230	200	178	160					
$\frac{1}{4}$	34						244	212		170	140				
$\frac{1}{4}$	36						258	226		180	150				

When possible give the factory the privilege of substituting the next larger or smaller number of teeth. This may permit shipping from stock.



Simonds Metal Cutting Circular Saws
For Various Makes of Machines, and Different Styles of Teeth
Carried in Stock

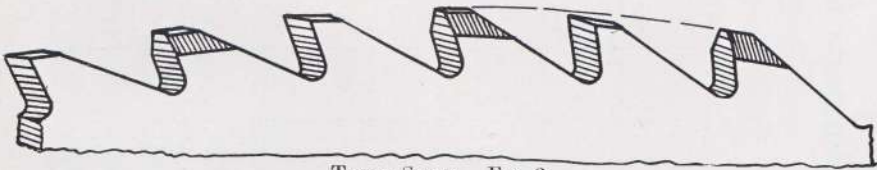

TOOTH STYLE. FIG. 3.

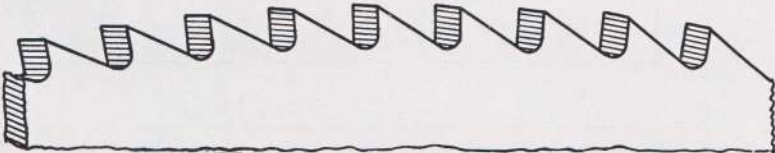

TOOTH STYLE. FIG. 4.

To any one interested in Metal Cutting Saws we will be glad to mail on request a copy of our special catalog, entitled "Methods of Cutting Metal," giving detailed information.

PRICE-LIST
Simonds Carbon Steel Metal Cutting Circular Saws
For All Makes of Machines for Cold Cutting

Diam. Inches	Thickness, Inches																
	$\frac{1}{32}$	$\frac{3}{64}$	$\frac{1}{16}$	$\frac{5}{64}$	$\frac{3}{32}$	$\frac{7}{64}$	$\frac{1}{8}$	$\frac{9}{64}$	$\frac{5}{32}$	$\frac{3}{16}$	$\frac{7}{32}$	$\frac{1}{4}$	$\frac{9}{32}$	$\frac{5}{16}$	$\frac{3}{8}$	$\frac{7}{16}$	$\frac{1}{2}$
9	\$5.00	\$5.15	\$5.30	\$5.45	\$5.75	\$5.90	\$6.05
10	6.50	6.70	6.90	7.10	7.50	7.70	7.90
12	8.50	9.00	9.25	9.50	\$10.00	\$10.50	\$11.00	\$11.75	\$13.00	\$14.00	\$15.00
14	9.75	10.25	10.50	11.00	12.00	13.00	13.50	14.25	15.75	17.50	18.75
16	11.75	12.50	13.00	13.50	14.25	15.00	16.25	17.25	19.25	21.00	23.50
18	14.75	15.00	15.25	15.50	17.00	18.25	19.50	20.50	23.00	25.50	28.00
20	17.50	18.00	18.25	18.50	19.75	21.00	23.25	25.50	27.50	30.50	33.50
22	21.50	23.25	24.75	27.00	29.25	32.75	36.50	39.50
24	26.25	28.50	30.50	32.75	35.00	38.75	43.00	48.00
26	28.50	31.25	34.00	37.50	41.00	45.50	49.50	54.50
28	34.50	37.50	41.00	44.25	50.50	56.25	62.00
30	41.00	44.00	47.00	50.00	57.00	64.00	71.00
32	53.00	57.00	61.00	68.00	76.00	82.00
34	58.50	62.75	67.00	75.50	84.00	92.50
36	65.00	69.50	74.00	84.00	93.00	102.50
38	88.50	98.50	110.00	121.00
40	118.50	132.50	143.00
42	132.50	144.00	157.50
44	142.50	157.00	172.00
46	155.50	172.00	187.50
48	174.00	192.50	210.50
50	194.00	215.00	236.00

For Prices on Semi-High Speed Metal Cutting Saws advance carbon list 25%

PRICE-LIST
Simonds High Speed Steel Metal Cutting Circular Saws

Diam. Inches	Thickness, Inches													
	$\frac{1}{32}$	$\frac{2}{64}$	$\frac{1}{16}$	$\frac{3}{32}$	$\frac{1}{8}$	$\frac{5}{32}$	$\frac{3}{16}$	$\frac{7}{32}$	$\frac{1}{4}$	$\frac{5}{16}$	$\frac{11}{32}$	$\frac{3}{8}$	$\frac{7}{16}$	$\frac{1}{2}$
9	\$16.00	\$21.00	\$23.00	\$25.00	\$28.00	\$31.00	\$36.00
10	18.50	22.50	26.50	30.00	33.00	36.50	44.00
11	32.00	36.00	40.00	44.00	48.00	54.00
12	36.50	41.50	46.50	51.00	56.00	62.00
13	42.00	47.50	53.50	59.00	65.00	72.00
14	47.00	54.00	60.50	67.00	74.00	84.00
15	57.00	68.00	76.00	84.00	96.00
16	67.00	76.00	85.00	94.00	108.00
17	75.00	85.00	95.00	105.00	122.00
18	83.00	94.00	105.00	116.00	138.00
19	92.00	105.00	117.00	130.00	154.00
20	101.00	115.00	128.00	142.00	170.00
21	126.00	140.00	156.00	185.00
22	137.00	152.00	170.00	205.00
23	149.00	166.00	185.00	222.00
24	161.00	179.00	200.00	240.00
25	219.00	260.00
26	235.00	280.00
27	252.00	302.00
28	275.00	320.00
30	366.00	\$400.00	\$435.00
31	396.00	434.00	470.00
32	422.00	460.00	498.00
34	520.00	560.00
36	622.00	\$715.00	\$810.00

Metal Saw Specifications

Q & C Bryant Metal Saws

Machine No.	Diameter Saw	Thickness	Center Hole	Pin Holes	Number Teeth
5, 5A	16	$\frac{9}{64}, \frac{3}{16}$	$\frac{7}{8}$		31
1M	18	$\frac{7}{32}$	$1\frac{3}{4}$		44
6, 6A	$20\frac{1}{2}$	$\frac{1}{4}$	$1\frac{1}{4}$		38
2B	$23\frac{1}{2}$	$\frac{1}{4}$	$1\frac{3}{4}$	$3-\frac{13}{16}-3$ $3-\frac{3}{32}-3\frac{1}{8}$ Ctsk. RH.	44
15	25				46
3B	28	$\frac{1}{4}, \frac{17}{64}$	$1\frac{3}{4}$	$3-\frac{13}{16}-3$ $3-\frac{13}{32}-3\frac{1}{8}$ Ctsk. RH.	52
20	30				40
4B	$31\frac{1}{4}$	$\frac{1}{4}, \frac{17}{64}$	$1\frac{3}{4}$	$3-\frac{13}{16}-3$ $3-\frac{3}{32}-3\frac{1}{8}$ Ctsk. RH.	58
50	36	$\frac{1}{4}, \frac{17}{64}$			67

Knowlton Metal Saws

Machine No.	Diameter Saw	Thickness	Center Hole	Pin Holes	Number Teeth
	18	$\frac{3}{16}$	2	$3-\frac{9}{16}-3\frac{1}{2}$	112
	20	$\frac{3}{16}$	2	$3-\frac{9}{16}-3\frac{1}{2}$	124
	22	$\frac{7}{32}$	2	$3-\frac{9}{16}-3\frac{1}{2}$	138
	24	$\frac{7}{32}$	2	$3-\frac{9}{16}-3\frac{1}{2}$	100

Cochrane-Bly Metal Saws

Machine No.	Diameter Saw	Thickness	Center Hole	Pin Holes	Number Teeth
1	$13\frac{1}{2}$	$\frac{1}{8}$	$1\frac{1}{2}$	$3-\frac{9}{16}-2\frac{5}{8}, 1-\frac{3}{16}-2\frac{11}{16}$	76
2B	15	$\frac{5}{32}$	$1\frac{1}{2}$	$3-\frac{9}{16}-2\frac{5}{8}, 1-\frac{3}{16}-2\frac{11}{16}$	76
4B	18	$\frac{3}{16}$	$1\frac{1}{2}$	$3-\frac{9}{16}-2\frac{5}{8}, 1-\frac{3}{16}-2\frac{11}{16}$	76
5	22	$\frac{3}{16}$	$1\frac{1}{2}$	$3-\frac{11}{16}-3, 1-\frac{3}{16}-2\frac{11}{16}$	76
6	24	$\frac{7}{32}$	$1\frac{1}{2}$	$3-\frac{11}{16}-3, 1-\frac{3}{16}-2\frac{11}{16}$	86

Higley Metal Saws

Machine No.	Diameter Saw	Thickness	Center Hole	Pin Holes	Slots	Number Teeth
$11\frac{1}{2}$ B	11	$\frac{1}{8}$	$1\frac{1}{4}$		21	
10	$12\frac{1}{2}$	$\frac{1}{8}$	$1\frac{1}{4}$		32	
11	$13\frac{1}{2}$	$\frac{5}{32}$	$1\frac{1}{4}$		32	
$11\frac{1}{2}$	14	$\frac{3}{16}$	$1\frac{1}{4}$		28	
12	15	$\frac{3}{16}$	$1\frac{1}{4}$		28	
14	18	$\frac{3}{16}$	$1\frac{1}{4}$		28	
15	20	$\frac{3}{16}$	$1\frac{1}{4}$	$8\frac{3}{8}, 2\frac{3}{8}$ special screws	28	
16	20	$\frac{3}{16}$	$1\frac{1}{4}$		28	
17	21	$\frac{3}{16}$	$1\frac{1}{4}$		25	
19	26	$\frac{1}{4}$	$1\frac{1}{2}$		36	
18, 20	31	$\frac{1}{4}$	$1\frac{1}{2}$		38	
$20\frac{1}{2}, 21, 21\frac{1}{2}$	36	$\frac{5}{16}$	$1\frac{1}{2}$		36	
22	40		$1\frac{1}{2}$		46	
26	33	$\frac{1}{4}$	$1\frac{1}{2}$		38	

Key Seat for above Saws, $\frac{5}{16} \times \frac{7}{16}$

Metal Saw Specifications

Nutter-Barnes Metal Saws

Machine No.	Diameter Saw	Thickness	Center Hole	Pin Holes	Number Teeth
4	14	$\frac{1}{8}$	$1\frac{3}{8}$	$3-\frac{17}{32}-2\frac{13}{16}, 1-\frac{3}{16}-3\frac{3}{32}$	78-104
6	16	$\frac{5}{32}$	$1\frac{3}{8}$	$3-\frac{17}{32}-2\frac{13}{16}, 1-\frac{3}{16}-3\frac{3}{32}$	90-126
8	22	$\frac{7}{16}$	$1\frac{3}{8}$	$4-\frac{17}{32}-3\frac{1}{4}, 1-\frac{3}{16}-3\frac{3}{32}$	90-126
10	26	$\frac{7}{32}$	2	$4-\frac{19}{32}-4\frac{1}{4}, 1-\frac{1}{4}-4\frac{1}{4}$	148

Espen-Lucas Metal Saws

Machine No.	Diameter Saw	Thickness	Center Hole	Pin Holes	Number Teeth
11	14	$\frac{5}{16}$	$1\frac{1}{2}$	$3-\frac{9}{16}-3\frac{1}{2}$	76
23	20	$\frac{7}{32}$	2	$3-\frac{11}{16}-3\frac{1}{2}$	84, 100, 124
22	22	$\frac{7}{32}$	$2\frac{1}{2}$	$3-\frac{11}{16}-5$	108
	30	$\frac{1}{4}$	$2\frac{1}{2}$	$6-\frac{13}{16}-7$	124

Lea-Simplex Metal Saws

Machine No.	Diameter Saw	Thickness	Center Hole	Slots	Number Teeth
	15	$\frac{3}{16}$	$1\frac{1}{4}$	28	76
	18	$\frac{3}{16}$	$1\frac{1}{4}$	28	76
	21	$\frac{3}{16}$	$1\frac{1}{4}$	28	76
	24	$\frac{7}{32}$	$1\frac{1}{4}$	28	86

Key Seats for above Saws $\frac{5}{16} \times \frac{7}{16}$

Burr Metal Saws

Machine No.	Diameter Saw	Thickness	Center Hole	Pin Holes	Number Teeth
1	10	$\frac{3}{32}$	$\frac{7}{8}$	$3-\frac{3}{8}-1\frac{3}{4}$	80, 160
2	14	$\frac{5}{32}$	$1\frac{1}{4}$	$3-\frac{17}{32}-2\frac{3}{8}$	88, 100, 120
3	16	$\frac{3}{16}$	$1\frac{1}{2}$	$4-\frac{17}{32}-2\frac{3}{4}$	80, 100

Newton Metal Saws

Machine No.	Diameter Saw	Thickness	Center Hole	Pin Holes	Number Teeth
U0	$12\frac{1}{2}$	$\frac{5}{32}$	$1\frac{1}{2}$	$6-1\frac{1}{2}-4$	
U1	18, $18\frac{3}{4}$, 20	$\frac{3}{16}$	$1\frac{1}{4}$	$6-\frac{9}{16}-5$	
U2	24, 26	$\frac{7}{32}$	$2\frac{1}{2}$	$6-\frac{5}{8}-7\frac{7}{8}$	
U3	30, 32	$\frac{1}{4}$	$2\frac{1}{2}$	$6-\frac{5}{8}-8\frac{7}{8}$	
U4	36	$\frac{1}{4}$	$3\frac{1}{2}$	$6-\frac{7}{8}-10$	

Q. M. S. Arbor Driven Saws

Machine No.	Diameter Saw	Thickness	Center Hole	Pin Holes	Number Teeth
1A Universal	21	$\frac{1}{4}$			
2A Universal	27	$\frac{1}{4}$			
3A Universal	33	$\frac{1}{4}$			
1A Cut-Off	21	$\frac{1}{4}$			
2A Cut-Off	27	$\frac{1}{4}$			
3A Cut-Off	33	$\frac{1}{4}$			

Circular Saws for Cutting Brass or Copper

Saws for cutting brass, copper, aluminum and other soft metals in the form of sheets, tubing and light cuts are made from carbon steel, concave ground on the sides for clearance, and tempered to be sharpened with a file. Also made flat ground with teeth set and filed.

Diam. of Saw	Thickness					Holes	Teeth per Saw	Teeth per Inch
4	$\frac{1}{32}$	$\frac{3}{64}$	$\frac{1}{16}$			$\frac{1}{2}$ " and larger	100 120	8 10
5	$\frac{1}{32}$	$\frac{3}{64}$	$\frac{1}{16}$			$\frac{3}{4}$ " and larger	130 150 190	8 10 12
6	$\frac{1}{32}$	$\frac{3}{64}$	$\frac{1}{16}$			$\frac{3}{4}$ " and larger	70 110 150 190	4 6 8 10
8	$\frac{1}{32}$	$\frac{3}{64}$	$\frac{1}{16}$			$\frac{3}{4}$ " and larger	100 150 200	4 6 8
10		$\frac{3}{64}$	$\frac{1}{16}$	$\frac{5}{64}$	$\frac{3}{32}$	$\frac{3}{4}$ " and larger	130 190 250	4 6 8
12				$\frac{5}{64}$	$\frac{3}{32}$	1" and larger	150 220	4 6

Speeds for above saws figured on a rim speed of 2500 feet per minute. On extremely light cuts this speed can be slightly increased. On heavier cuts this speed should be reduced.

Diameter	R. P. M.	Diameter	R. P. M.
3	3205	8	1196
4	2381	10	954
5	1908	12	796
6	1592		

Electrotype Saws

Machine Maker	Dia.	Thick.	Hole	Teeth	Style Sharpening	Pinholes
Barnhart Bros. and Spindler	5 $\frac{1}{2}$.068	$\frac{7}{8}$	68	Concave ground, filed only	6 Standard
"	5 $\frac{1}{2}$.068	$\frac{7}{8}$	68	Swaged teeth	6 Standard
"	5 $\frac{1}{2}$.068	$\frac{7}{8}$	68	Set and filed	6 Standard
Goss Ptg. Press Co.	10	.072	1	128	Set and filed	None
Hill Curtis Co.	7	.068	2 $\frac{1}{4}$	84	Swaged teeth	4 Screw holes
"	7	.068	2 $\frac{1}{4}$	84	Set and filed	4 Screw holes
Miller Saw Trimmer Co.	6	.062	$\frac{7}{8}$	64	Concave ground, filed only	6 Standard
"	6	.062	$\frac{7}{8}$	64	Swaged teeth	6 Standard
"	6	.062	$\frac{7}{8}$	64	Set and filed	6 Standard
"	5	.058	$\frac{7}{8}$	32	Formed copper teeth	6 Standard
"	5	.083	$\frac{7}{8}$	32	Formed copper teeth	6 Standard
J. A. Richards	6 $\frac{1}{2}$.058	1 $\frac{1}{8}$	72	Set and filed	3 or 6 pinholes
"	6 $\frac{1}{2}$.080	1 $\frac{1}{8}$	120	Concave ground, filed only	3 or 6 pinholes
"	6 $\frac{1}{2}$.083	1 $\frac{1}{8}$	72	Concave ground, filed only	3 or 6 pinholes
"	6 $\frac{1}{2}$.083	1 $\frac{1}{8}$	64	Concave ground, filed only	3 or 6 pinholes
H. B. Rouse	4 $\frac{1}{2}$.042	$\frac{1}{2}$	100	Concave ground, filed only	Special Keyway
"	5	.064	$\frac{1}{2}$	100	Concave ground, filed only	Special Keyway
Wondersaw Mfg. Co.	6	.047	$\frac{7}{8}$	90	Set and filed	5 pinholes
"	6	.062	$\frac{7}{8}$	64	Swage teeth	5 pinholes

Simonds Inserted Tooth Metal Saws

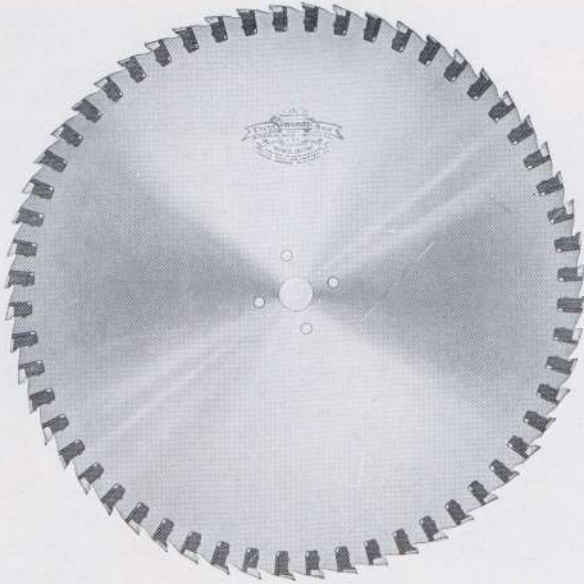

Here is an Inserted Tooth Metal Saw, simple in design, and built on correct mechanical lines for heavy duty. It will give excellent satisfaction. Let us know the make of your machine, size of saw wanted and the dimensions, kind and carbon of stock you desire to cut, and we will furnish you a saw that will not only cut the stock but will also cut the time ordinarily required to do it. Plate made in our own Steel Mill of high-grade carbon steel scientifically heat treated and flattened without hammering. Teeth made of High Speed Steel.

Made to fit any type of arbor driven machine.

The projection on the front holds the bottom of the tooth firmly on the plate so the tooth cannot work up or down. This makes it unnecessary to drive the wedge hard enough to disturb the tension or distort the plate in any way.

The oval teeth are slightly higher, cutting a channel in front of the square teeth which breaks the chip in three pieces, allowing it to clear and come out freely, thereby avoiding the troubles of the material becoming welded on the face of the tooth and the side of the saw.

Simonds Inserted Tooth Metal Saws

No. 000 Fine Tooth

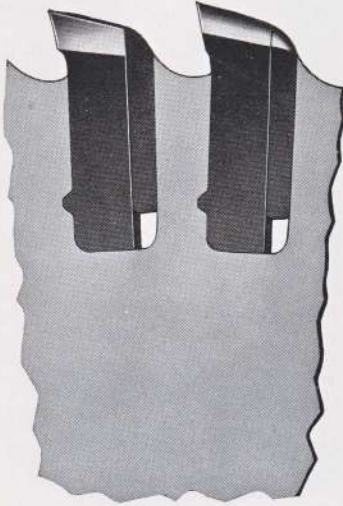

The illustration shows actual size of tooth of the Simonds No. 000 Saw. The Simonds No. 000 is a fast cutting saw in which it is possible to put almost double the number of teeth that can be inserted in our No. 00 saw. This greater number of teeth eliminates chatter caused by the work jumping from one tooth to another in cutting the thin walls in I Beams, Channels and other material of similar construction. Consequently there is less wear on the saw and machine.

These saws are made from 10 inches in diameter with a kerf of $\frac{1}{4}$ inch and 36 teeth, to 50 inches in diameter with kerf of $\frac{1}{2}$ or $\frac{7}{16}$ inches, holding 180 teeth.

It is a saw made along the general lines of our other well known Inserted Tooth Metal Saw, containing the same grade of High Speed Steel cutting points, but with the teeth spaced much closer. The illustration at the upper left

of this page shows the design and method of tooth arrangement. Through this method, the teeth, although closer together, are firmly fastened into the plate.

Diam. Inches	Thickness of Plate	Kerf	Standard No. of Teeth	List Price	Diam. Inches	Thickness of Plate	Kerf	Standard No. of Teeth	List Price
10	$\frac{1}{16}$	$\frac{1}{4}$	36	\$100.00	32	$\frac{1}{16}$	$\frac{3}{16}$	114	310.00
12	$\frac{1}{16}$	$\frac{1}{4}$	44	110.00	32	$\frac{3}{16}$	$\frac{3}{16}$ or $\frac{1}{16}$	114	335.00
14	$\frac{1}{16}$	$\frac{1}{4}$	50	125.00	32	$\frac{1}{16}$	$\frac{1}{16}$	114	360.00
16	$\frac{1}{16}$	$\frac{1}{4}$	58	140.00	34	$\frac{1}{16}$	$\frac{1}{16}$	122	335.00
18	$\frac{1}{16}$	$\frac{1}{4}$	76	170.00	34	$\frac{3}{16}$	$\frac{3}{16}$ or $\frac{1}{16}$	122	360.00
20	$\frac{1}{16}$	$\frac{1}{4}$	84	185.00	34	$\frac{1}{16}$	$\frac{1}{16}$	122	390.00
20	$\frac{1}{16}$	$\frac{3}{8}$	84	195.00	36	$\frac{1}{16}$	$\frac{1}{16}$	130	360.00
20	$\frac{1}{16}$	$\frac{3}{8}$	84	205.00	36	$\frac{3}{8}$	$\frac{1}{16}$ or $\frac{1}{16}$	130	390.00
22	$\frac{1}{16}$	$\frac{3}{8}$	92	200.00	36	$\frac{1}{16}$	$\frac{1}{16}$	130	420.00
22	$\frac{1}{16}$	$\frac{3}{8}$	92	210.00	38	$\frac{1}{16}$	$\frac{1}{16}$ or $\frac{1}{16}$	136	420.00
22	$\frac{1}{16}$	$\frac{3}{8}$	92	220.00	38	$\frac{3}{8}$	$\frac{1}{16}$ or $\frac{1}{16}$	136	450.00
24	$\frac{1}{16}$	$\frac{1}{4}$	100	220.00	40	$\frac{1}{16}$	$\frac{1}{16}$	144	450.00
24	$\frac{1}{16}$	$\frac{1}{4}$	100	230.00	40	$\frac{3}{8}$	$\frac{1}{16}$ or $\frac{1}{16}$	144	480.00
24	$\frac{1}{16}$	$\frac{3}{8}$	100	240.00	42	$\frac{1}{16}$	$\frac{1}{16}$	150	480.00
26	$\frac{1}{16}$	$\frac{1}{4}$	108	240.00	42	$\frac{3}{8}$	$\frac{1}{16}$ or $\frac{1}{16}$	150	515.00
26	$\frac{1}{16}$	$\frac{1}{4}$	108	250.00	44	$\frac{1}{16}$	$\frac{3}{8}$	158	515.00
26	$\frac{1}{16}$	$\frac{3}{8}$	108	265.00	44	$\frac{3}{8}$	$\frac{1}{16}$ or $\frac{1}{16}$	158	550.00
26	$\frac{1}{16}$	$\frac{3}{8}$	108	285.00	46	$\frac{1}{16}$	$\frac{3}{8}$	166	550.00
26	$\frac{1}{16}$	$\frac{3}{8}$	108	285.00	46	$\frac{3}{8}$	$\frac{1}{16}$ or $\frac{1}{16}$	166	585.00
28	$\frac{1}{16}$	$\frac{1}{4}$	116	260.00	48	$\frac{1}{16}$	$\frac{3}{8}$	172	585.00
28	$\frac{1}{16}$	$\frac{1}{4}$	116	270.00	48	$\frac{3}{8}$	$\frac{1}{16}$ or $\frac{1}{16}$	172	620.00
28	$\frac{1}{16}$	$\frac{3}{8}$	116	285.00	50	$\frac{1}{16}$	$\frac{3}{8}$	180	620.00
28	$\frac{1}{16}$	$\frac{3}{8}$	116	310.00	50	$\frac{3}{8}$	$\frac{1}{16}$ or $\frac{1}{16}$	180	655.00
30	$\frac{1}{16}$	$\frac{1}{4}$	124	290.00					
30	$\frac{1}{16}$	$\frac{3}{8}$	124	310.00					
30	$\frac{1}{16}$	$\frac{3}{8}$	124	335.00					

Simonds Inserted Tooth Metal Saws

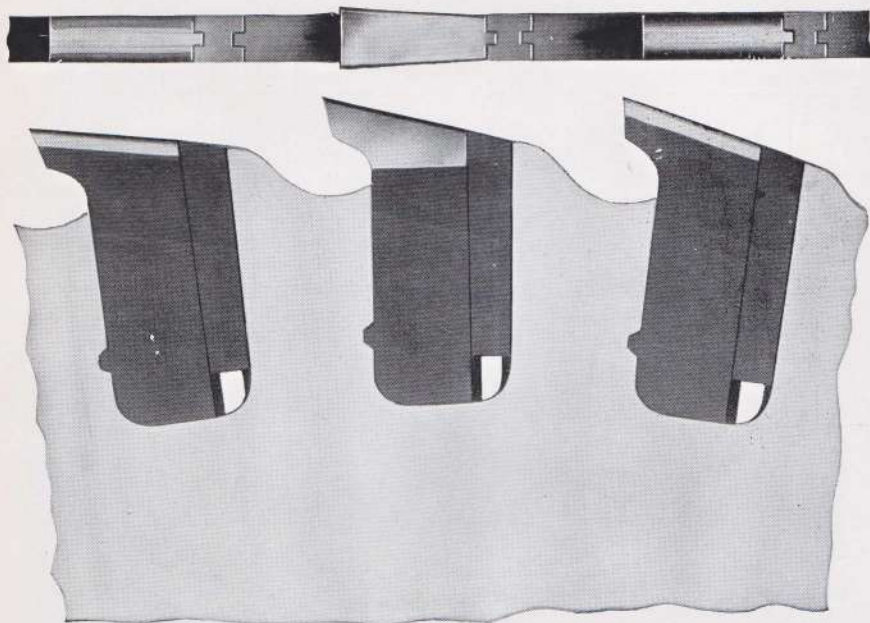

The illustration shows the exact size of tooth No. 1. Nos. 0, 00 and 000 are smaller.

The No. "00" Tooth is especially designed to meet the cutting conditions in the average machine shop and for cutting of high-priced steel. The No. "00" Tooth is shorter and narrower than No. "0" Tooth. This makes it possible to get more teeth in a saw and to successfully cut a $\frac{3}{16}$ inch kerf, which is as narrow as the usual kerf of a solid tooth saw. This causes no greater waste of material and gives all the advantage of the full High Speed Steel cutting point, backed up by a plate which will not crack or break under double the feed which could be given a solid all hard blade. Full High Speed Steel teeth will stay sharp very much longer than the teeth in a solid saw, and when they do become dull they can be sharpened much quicker and easier than a solid saw.

Extra Teeth, High Speed Steel

Plate	Kerf	No. 000	No. 00	No. 0	No. 1	No. 2
$\frac{9}{64}$	$\frac{3}{16}$		\$0.70			
$\frac{3}{16}$	$\frac{1}{4}$	0.65		\$0.80		
$\frac{1}{4}$	$\frac{5}{16}$.70		.90		
$\frac{5}{16}$	$\frac{3}{8}$.75			\$1.35	
$\frac{3}{8}$	$\frac{7}{16}$ or $\frac{15}{32}$.80				\$1.75

Extra Wedges: No. 000, $\frac{3}{16}$ to $\frac{5}{16}$, \$0.35; $\frac{3}{8}$, \$0.40. No. 00, \$0.35. No. 0, \$0.35. No. 1, \$0.40. No. 2, \$0.50.

Saws any diameter can be furnished the thickness of plate shown in the list or any increased thickness of plate up to the maximum listed for any larger diameter saw in the same list. Prices for saws extra thick quoted on application.

SIMONDS—"THE SAW MAKERS"

Simonds Inserted Tooth Metal Saws

No. 00

(1/16" narrower and 1/4" shorter than No. 0)

Diam. Inches	Thick-ness of Plate	Kerf	No. of Teeth	List Price	Diam. Inches	Thick-ness of Plate	Kerf	No. of Teeth	List Price
10	3/64	3/16	22	\$69.00	16	9/64	3/16	36	\$94.00
12	9/64	3/16	26	69.00	18	9/64	3/16	42	110.00
12 1/2	9/64	3/16	28	80.00	20	9/64	3/16	46	120.00
13 1/2	9/64	3/16	30	80.00	21	9/64	3/16	50	133.00
14	9/64	3/16	30	80.00	22	9/64	3/16	52	133.00
15	9/64	3/16	36	94.00					

No. 0

(1/16" narrower and 1/4" shorter than No. 1)

Diam. Inches	Thick-ness of Plate	Kerf	No. of Teeth	List Price	Diam. Inches	Thick-ness of Plate	Kerf	No. of Teeth	List Price
14	3/16	1/4	28	\$80.00	28	3/16	1/4	60	\$200.00
15	3/16	1/4	30	94.00	28	3/16	5/16	60	210.00
16	3/16	1/4	32	94.00	30	3/16	1/4	60	215.00
16	1/4	5/16	32	100.00	30	1/4	5/16	60	225.00
18	3/16	1/4	36	110.00	31	3/16	1/4	62	235.00
18	1/4	5/16	36	115.00	31	1/4	5/16	62	245.00
20	3/16	1/4	40	120.00	32	3/16	1/4	66	235.00
20	1/4	5/16	40	130.00	32	1/4	5/16	66	245.00
21	3/16	1/4	42	133.00					
21	1/4	5/16	42	145.00	34	1/4	5/16	72	255.00
22	3/16	1/4	46	133.00	36	1/4	5/16	72	270.00
22	1/4	5/16	46	145.00	38	1/4	5/16	72	290.00
24	3/16	1/4	50	155.00	40	1/4	5/16	74	310.00
24	1/4	5/16	50	165.00	42	1/4	5/16	76	330.00
26	3/16	1/4	56	175.00					
26	1/4	5/16	56	185.00					

No. 1

(Size shown in illustration)

Diam. Inches	Thick-ness of Plate	Kerf	No. of Teeth	List Price	Diam. Inches	Thick-ness of Plate	Kerf	No. of Teeth	List Price
18	5/16	3/8	34	\$120.00	32	5/16	3/8	56	\$265.00
20	5/16	3/8	38	150.00	34	5/16	3/8	58	280.00
21	5/16	3/8	40	170.00	36	5/16	3/8	60	295.00
					38	5/16	3/8	62	315.00
22	5/16	3/8	42	170.00	40	5/16	3/8	66	335.00
24	5/16	3/8	46	195.00	42	5/16	3/8	68	355.00
26	5/16	3/8	50	215.00	44	5/16	3/8	70	380.00
					46	5/16	3/8	74	410.00
28	5/16	3/8	50	225.00	48	5/16	3/8	78	450.00
30	5/16	3/8	54	245.00	50	5/16	3/8	80	500.00
31	5/16	3/8	56	265.00					

No. 1. This style should be made in 5/16 plate x 3/8 kerf only, which will give you a saw that can be made from 18" to 50" inclusive, but there would seem to be no necessity to go smaller in diameter than 24", this being as small a saw as the heavier machines would ordinarily use.

Simonds Inserted Tooth Metal Saws

No. 2

Diameter Inches	Thickness of Plate	Kerf	Number of Teeth	List Price
26	$\frac{3}{8}$	$\frac{7}{16}$ or $\frac{15}{32}$	46	\$220.00
28	$\frac{3}{8}$	$\frac{7}{16}$ or $\frac{15}{32}$	46	235.00
30	$\frac{3}{8}$	$\frac{7}{16}$ or $\frac{15}{32}$	48	255.00
32	$\frac{3}{8}$	$\frac{7}{16}$ or $\frac{15}{32}$	50	275.00
34	$\frac{3}{8}$	$\frac{7}{16}$ or $\frac{15}{32}$	52	290.00
36	$\frac{3}{8}$	$\frac{7}{16}$ or $\frac{15}{32}$	56	310.00
38	$\frac{3}{8}$	$\frac{7}{16}$ or $\frac{15}{32}$	60	335.00
40	$\frac{3}{8}$	$\frac{7}{16}$ or $\frac{15}{32}$	62	365.00
42	$\frac{3}{8}$	$\frac{7}{16}$ or $\frac{15}{32}$	64	400.00
44	$\frac{3}{8}$	$\frac{7}{16}$ or $\frac{15}{32}$	68	430.00
46	$\frac{3}{8}$	$\frac{7}{16}$ or $\frac{15}{32}$	72	475.00
48	$\frac{3}{8}$	$\frac{7}{16}$ or $\frac{15}{32}$	74	525.00
50	$\frac{3}{8}$	$\frac{7}{16}$ or $\frac{15}{32}$	76	575.00
52	$\frac{3}{8}$	$\frac{7}{16}$ or $\frac{15}{32}$	78	610.00
54	$\frac{3}{8}$	$\frac{7}{16}$ or $\frac{15}{32}$	80	650.00
56	$\frac{3}{8}$	$\frac{7}{16}$ or $\frac{15}{32}$	82	710.00
58	$\frac{3}{8}$	$\frac{7}{16}$ or $\frac{15}{32}$	86	780.00
60	$\frac{3}{8}$	$\frac{7}{16}$ or $\frac{15}{32}$	90	850.00
62	$\frac{3}{8}$	$\frac{7}{16}$ or $\frac{15}{32}$	94	925.00
64	$\frac{3}{8}$	$\frac{7}{16}$ or $\frac{15}{32}$	98	1000.00

Treatment of Metal Saws

Always Keep Saws Sharp. A dull saw is liable to break, and there is no guaranty on metal saws against breakage.

Round Saws after sharpening by revolving saw past the grinding wheel until every tooth shows a spark. A high tooth may break off while saw is in a cut, and if the tooth sticks in the cut the saw will be broken.

Emery Wheels must not be allowed to become glazed, as they will then draw temper of saw.

New Saws are carefully rounded, sharpened, and inspected before leaving our factory; but even so, when they are put on the arbor they should not be put into hard usage without first having been looked over very carefully.

It is not good practice to put new saws to a full feed until after the first or second resharpening. Sometimes the arbor is sprung slightly and a saw a little out of round. In such a case changing the position of the saw on the arbor will frequently help.

Gears and Bearings should all be tight fitting, so that there can be no false motion to the saw arbor.

Cutting Compound or a continuous stream of oil should be played on the teeth of the saw when cutting steel, just before it enters the cut, in the same manner as you treat your milling cutters.

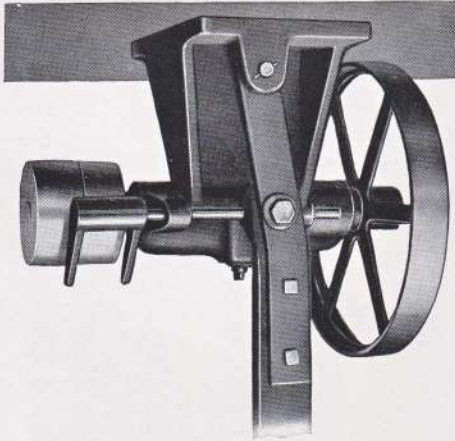

Countershaft For Simonds Inserted Tooth Metal Saw Grinding Machine

This illustration shows the improved countershaft with self-oiling bearings especially designed for use with the Simonds Inserted Tooth Metal Saw Grinding Machine. Carefully made of high grade material, this countershaft completes the sharpening machine.

Simonds Inserted Tooth Metal Saw Grinder

A light, inexpensive little machine with which you can keep your Inserted Point Saw in perfect cutting condition, doing the work quickly and accurately.

The Saw can be sharpened in ten to fifteen minutes if it is done when the corners show slightly dull.

It is not economy to run the Saw after the keen edge is gone. The clearance is gone, the teeth are rubbing and bruising, not cutting, and will dull very rapidly, using more power and being more likely to cause damage to the saw and machine, destroying the shape and clearance of the tooth, increasing the time and trouble of grinding and reducing the amount of material that can be cut with a set of teeth.

Furnished complete with two grinding wheels, one bevel wheel and one cup wheel, and an improved countershaft as illustrated.

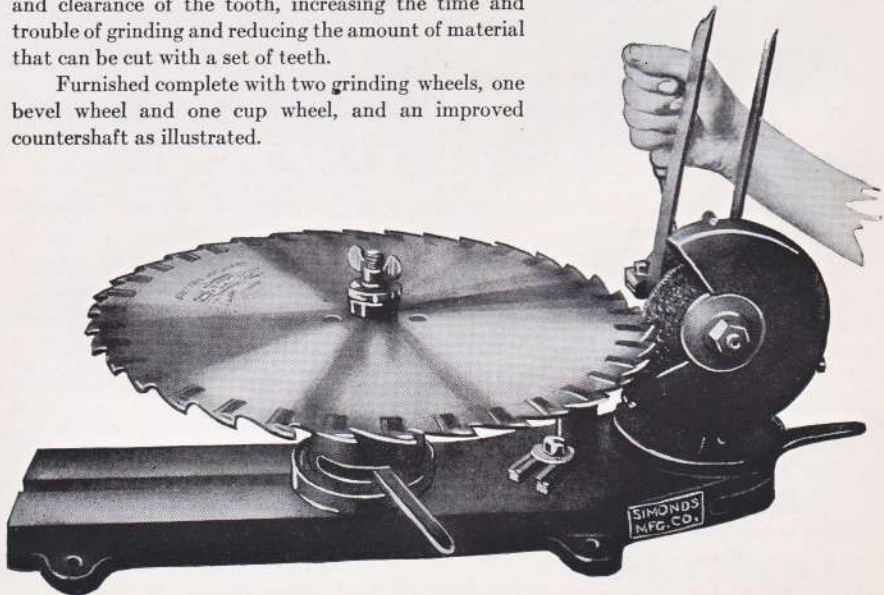

See Discount Sheet for Prices

Simonds Metal Cutting Band Saw Blades

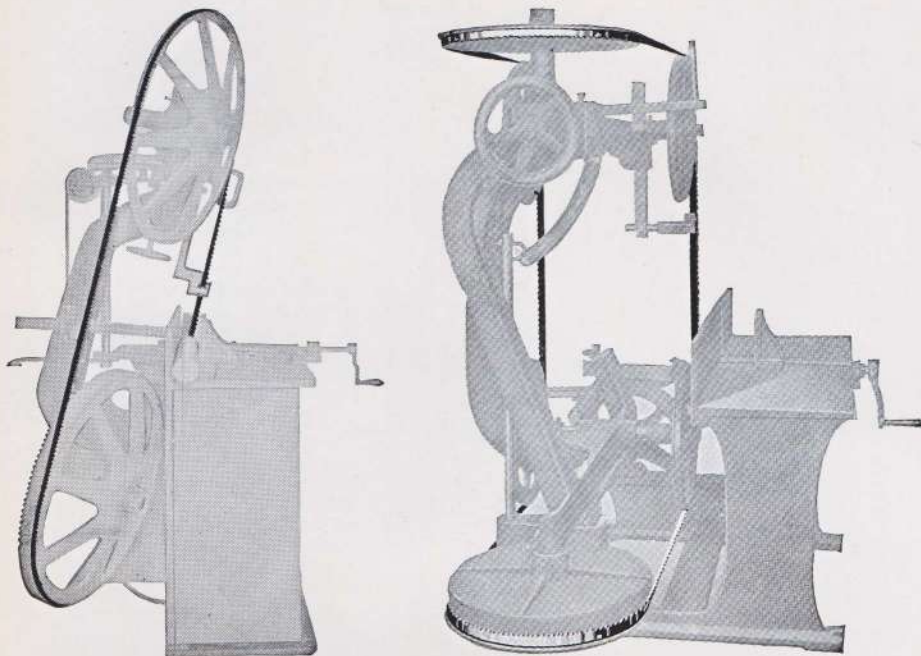

Every operator of a Metal Band Saw knows that the cutting power of his machine, whether it be cutting $\frac{1}{2}$ -inch bar or 12-inch round, is vitally dependent on the quality of the Band Saw Blade.

If you wish to improve your cutting results and reduce your blade expense, buy Simonds Saws.

Simonds special alloy steel blades are the most dependable blades on the market. They are made for any style of machine, and with teeth especially selected for the kind of cutting you do. We particularly recommend one of our Band Saws for cutting brass, zinc, and thin steel.

When ordering Metal Cutting Band Saw Blades give the length, width, thickness or gauge, number of teeth to the inch, the class of work to be cut, also the name and style of machine on which the blade is to operate.

List Prices

Width, Inches	Thickness	Price per Foot	Price per Pound	Price Brazing
$\frac{1}{4}$.025	.07		.20
$\frac{3}{8}$.025	.07		.20
$\frac{1}{2}$.025	.07		.20
$\frac{5}{8}$.028	.08		.25
$\frac{3}{4}$.032	.09		.30
1	.035	.11		.30

Simonds Tool Cabinets



TOOLS FOR THE AMATEUR CARPENTER

One of the handiest, most practical, and most satisfactory collections of tools for the boy or man who likes to make things of wood.

It contains the proper tools for general carpentry work about the home, farm, or shop.

The tools are all manufacturers' own brand articles of highest grade, widely and favorably known by tool users everywhere, and are covered by the respective manufacturers' liberal guarantees.

Tools neatly and conveniently arranged. Cabinet made of thoroughly seasoned chestnut with oak grain finish.

With each Cabinet we send a copy of "Simonds' Guide for Carpenters," a booklet giving rules and other items of information for the woodworker.

Each Cabinet contains one each:

Firmer Chisels, $\frac{1}{4}$ ", $\frac{1}{2}$ ", 1".

Firmer Gouge.

Cold Chisel.

Rose Countersink.

Ratchet Brace.

Steel Handle Wrench.

Hammer.

Auger Bits, $\frac{1}{4}$ ", $\frac{3}{8}$ ", $\frac{1}{2}$ ".

Oilstone in Box.

Try Square.

Marking Gauge.

Boxwood Rule.

Jack Plane.

Level.

Spoke Shave.

Mallet.

Nail Set.

"T" Bevel.

Brad Awl.

Screwdriver.

Simonds Mfg. Co.'s 22" 10-point Hand Saw.

" " " 22" 7-point Rip Saw.

" " " 10" Back Saw.

Simonds Mfg. Co.'s Coping Saw with Blade.

" " " Keyhole Saw and Pad.

" " " Cabinet Scraper Blade.

" " " Hack Saw Frame.

" " " 8" Hard Edge Blade,

14 Teeth.

Simonds Mfg. Co.'s 8" Hard Edge Blade,

18 Teeth.

Simonds Mfg. Co.'s 8" Hard Edge Blade,

24 Teeth.

Simonds Mfg. Co.'s 8" Hard Edge Blade,

32 Teeth.

Simonds Mfg. Co.'s 8" Flat Bastard File.

" " " 8" Half Round Bastard

File.

Simonds Mfg. Co.'s 6" Slim Taper File.

" " " 8" Rat Tail File.

Oil Can.

Pair of Dividers.

Side Cutting Pliers.

End Cutting Carpenters' Pincers.

The size of the Cabinet is $3\frac{1}{2}$ " high, 16" wide, $7\frac{3}{4}$ " deep.

See Discount Sheet for Prices

SIMONDS

GUIDE FOR MILLMEN

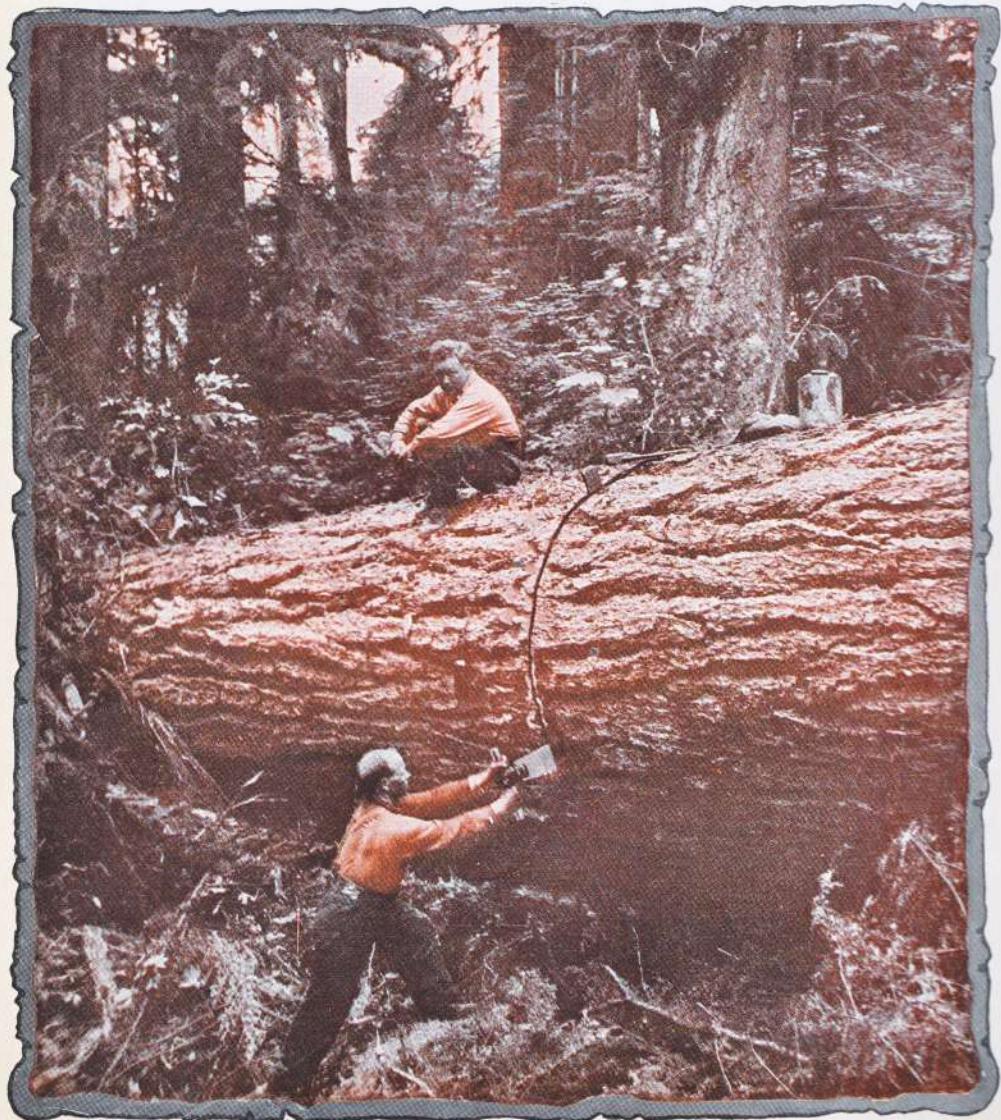

Sawmill Filers, Sawyers and Superintendents should send us their names so that we may send them free copies of each issue of *Simonds Guide for Millmen*—a magazine containing many items of interest for them

Window Displays Like These Make bigger sales for Dealers



S-A-W-S Form H-2184

This set of cards has a six-foot frontage, each card stands 27 inches high, is 20 inches wide—colors: red and black. Can be arranged across the back of a window, up and down or in a semi-circle. Makes a fine background for a saw or tool window.



Revolving Shade Display

Form H-2164

There is nothing like action to gain attention in a window. This display does it. An ordinary 40 candle power electric bulb placed beneath the shade. Holds actual saws, 24 or 26 inches, across the face of the display.



Embossed Counter Sign

Form H-2187

Gold letters embossed on a blue background. For use either on counter or in a window. Each 4 inches high by 16 inches long, equipped with a pedestal. Very high grade sign, looks like bronze.

The above and many other Window Display Signs furnished Simonds dealers on request.

INDEX

Addresses	5	Circular Saws, Solid Tooth, Edger	38
Adjustable Hack Saw Frames	162-163	Circular Saws, Inserted Tooth, Edger	20
Adjustable Saw Sets	65	Circular Saws for Roughing Handles	39
Adjustment of Keyhole Saws	129	Circular Saws, Grooving	21, 33
Anvils	61	Circular Saws, Hand of	24
Arbors	67	Circular Saws, I. T. Cut-off	22-23
Armstrong Swages and Shapers	64	Circular Saws, I. P. Rip	11-21
Back Saw Handles	144	Circular Saws, Lathe	39
Back Saws	131-132	Circular Saws, Metal	168-183
Band Saw Anvils	61	Circular Saws, Mitre	36-37
Band Saw Brazing Clamp	70	Circular Saws, Novelty	36-37
Band Saw Brazing Tongs	70	Circular Saws, Standard No. of Teeth	29
Band Saw Filing Clamp	69	Circular Saws, Price List—Solid	30-31
Band Saw Filing Machine	68	Circular Saws, Resawing or Siding	38
Band Saw Rig	46	Circular Saws, Shingle and Heading	32
Band Saw Setting Machine	68	Circular Saws, Slate	39
Band Saw Swages	62-64	Circular Saws, Speed of	29
Band Saw Shapers	64	Circular Saws, Styles of teeth	28
Band Saws	43-52	Circular Saws, Thin Rim	37
Band Saws, Metal	185	Circular Saws, Weights	42
Band Saws, Narrow	46-47	Clamps	69-70, 145
Band Saws, Wide	43, 48-52	Cloth Cutters	83
Band Saws, Wide-Style of Teeth	49	Collars for Shingle and Heading Saws	32
Bar-Swage and Hammer	60	Compass Saw Blades	127-128
Beef Splitting Saws	140	Compass Saw Handles	127-128, 143
Belt Knives	82	Concave Saws	35
Bench Saws	121	Coping Saws	130
Beveled Steel	75	Copper and Brass Saws	178
Bits for I. P. Groover Saws	21	Cork Cutters	83
Bits for I. P. Saws	13-23	Counter Shaft for I. T. Metal Saw Grinding Machine	184
Bits, Tool Holder	165	Creasing Rule	85
Bone Saws	31	Crescent Ground Cross-Cut Saws	86-95, 100, 101
Brass and Copper Saws	178	Crescent Saw Tools	108-110
Brazing Clamp	70	Cross-Cut Saw Handles	111-112
Brazing Lamp	70	Cross-Cut Saw Lever Sets	147-148
Brazing Tongs	70	Cross-Cut Saw Tools	107-110
Brazing Narrow Band Saws	47	Cross-Cut Saws	86-106
Butcher Block Scrapers	142	"Culley" Flexible Hack Saw Blades	160
Butcher Saw Blades	141	Curved Pruning Saws	136
Butcher Saw Blades in Coils	141	Cutting Rule	85
Butcher Saw Handles	143	Dehorning Saw	140
Butcher Saw Punch	141	Dado or Grooving Saws	34
Butcher Saws	137, 138	Difference between Points and Teeth per inch	46
Butting or Drag Saws	55	Docking Saw	133
Cabinet of Tools	186	Double Edge Band Saws	43
Cabinet Scrapers	142	Double Edge Pruning Saws	135
Cane Knives	84	Dovetail Saws	130
Chair Webs	58	Drag Saws	55-56
Chisel Bit Saws	16-19	Edger Saws, Inserted Point	20
Circular Cutters	83	Edger Saws, Solid Tooth	38
Cigarette Cutters	83	Electrotype Saws	178
Cloth Cutters	83	Factories, Illustration of	2
Cork Cutters	83	Fay Thin Back Scroll Saws	60
Circular Saw, Illustrating Repairing	40	Felloe Webs	58
Circular Saw Repairing List	41	Files and Rasps	155, 156, 157
Circular Saw Sets	65, 147	Filing Clamps	69, 145
Circular Saws	11-42, 168-183		
Circular Saws, Bone, Horn, Ivory	31		
Circular Saws, Concave	35		

SIMONDS—"THE SAW MAKERS"

Filing Machine for Narrow Bands	68	Inserted Tooth Metal Saw Grinder	184
Fitting Circular Saws	30, 31, 41	Interchangeable Compass Saws and Blades	128
Flanges for Shingle and Heading Saws	32	Ivory Saws	31
Flat Ground Stock	165	IXL Saws	16-19
Flexible Hack Saw Blades	160	Joiner Saws	121
Flooring Saws	121	Jointer, Hand Saw	145
Frames for Hack Saws	162, 163	Keyhole Saws	129
Frames for Web Saws	59	Kitchen Saws	139
Frames for Wood Saws	149-152	Knives	71-84
Gang Saws	53-56	Knives, Barker	77
Gauges, Our Standard	10, 66	Knives, Barrel	78
Gauges, Saw	10, 66	Knives, Belt	82
Grinding Machine for Inserted Tooth Metal Saws	184	Knives, Cane	84
Grooving Saw, Inserted Tooth	21	Knives, Chair Bottom	75
Grooving Saw, Solid Tooth	33	Knives, Chipper	77
Guide for Band Saws	69	Knives, Circular	83
Hack Hand Saws	121	Knives, Excelsior	76
Hack Saw Blades	158-160	Knives, Hog	77
Hack Saw Blades, "Culley"	160	Knives, Jointer	78
Hack Saw Blades, Hard Edge	158-159	Knives, Lathe	76
Hack Saw Blades, Power	159	Knives, Leather	81
Hack Saw Blades, Hand	158	Knives, Mitre	76
Hack Saw Blades, Simonds	158-159	Knives, Moulding	75
Hack Saw Frames	162-163	Knives, Paper	78
Hammer, Cross-Cut Setting	108-110	Knives, Planer	75
Hammer, Saw Makers'	61	Knives, Rag	81
Hanchett Swage and Shaper	63	Knives, Shear	80
Hand of Saws, Right or Left	24	Knives, Shingle	78
Hand Ice Saws	114	Knives, Slicer	80
Hand Saws	115-124	Knives, Stave	78
Hand Saws, Standard Styles	117-120	Knives, Tobacco	79
Hand Saws, Simonds "Blue Ribbon"	118-119	Knives, Veneer	78
Hand Saws, Simonds Brand	120	Knives, Washboard	76
Hand Saw Clamp	145	Lamp, Brazing	70
Hand Saw Handles	143-144	Lance Tooth Drag Saws	56
Hand Saw Jointer	145	Lathe Saws	39
Hand Saw Sets	145-148	Leather Cutters	81-83
Handles for Cross-Cut Saws	111-112	Leveling Blocks for Band Saws	61
Handles for Back, Compass, Pruning Saws	143-144	Lever Saw Sets	145-148
Handles for Butcher and Hand Saws	143	Lock Corner Cutters	33
Handles, Tiller	57	Long Saws	53-57
Hard Edge Hack Saw Blades	158-159	Machine Knives	71-83
Heading Saws	32	Mandrels	67
High Speed Steel Knives	73-75	Medals Awarded	4
Higley Metal Saws	170	Metal Saws, Band	185
Hollow Back Cross-Cut Saws	90, 91, 98, 99	Metal Saws, Circular	168-183
Horn Saws	31	Metal Saws, Inserted Tooth	179-183
Ice Saws	113-114	Metal Saws, Slitting	168-169
Inserted Point Saws	11-23	Metal Saws, Slotters	166-167
Inserted Point Cut-Off Saws	22-23	Metal Saw Specifications	176-177
Inserted Point Edger Saws	20	Mill Saws	56
Inserted Point Grooving Saws	21	Milling Saws for Metal	176-177
Inserted Point Price List	15, 18, 19, 20, 21, 23	Mitre Box Saws	131
Inserted Point Rift Saws	20	Mitre Saws	36-37
Inserted Tooth Metal Saw Grind. Counter Shaft	184	Mulay Saws	56
		Nail Cutting Saws	121, 126
		Narrow Band Saws	46-47
		Narrow Band Saws in Coils	46
		Narrow Cross-Cut Saws	90, 91, 98, 99
		Nest of Saws	125-126

SIMONDS—"THE SAW MAKERS"

Novelty Saws	36-37	Shingle Saws	32
Number of Teeth in Cir. Saws	29	Shipping Directions	7
One Man Cross-Cut Saws	100-106	Siding Saws or Resaws	38
Paper Cutting Knives	78	Silver Solder	70
Pattern Maker's Saws	130	Slate Saws	39
Perforating Steel Rule	85	Slotting Blades	161
"Pistol Grip" Hack Saw Frames	163	Solid Tooth Circular Saws	30-31
"Pistol Grip" Saw Sets	148	Specifications—Metal Saws	176-177
Pit Saws	57	Speed Indicators	66
Plumbers' Nest of Saws	126	Speed of Circular Saws	29
Points for Inserted Point Saws	13-19	Standard Gauges	10-66
Points for Inserted Point Groovers	21	Standard Number of Teeth in Circular Saws	29
Pond Ice Saws	113	Steel Cutting and Creasing Rule	85
Power Hack Saw Blades	159	Steel, Process of making	8-9
Pruning Saws	133-136	Steel Scales	66
Pulp Saws	22-23	Steel Tapes	66
Punch, Butcher Saw	141	Straight Cut Hack Saw Frames	163
Q & C Metal Saws	171	Straight Edges	61
Rail Hack Saw Frames	164	Styles of Circular Saw Teeth	28
Raker Gauges	109-110	Supplementary Handles	112
Rasps and Files	156-157	Swage Bar and Hammer	60
Remittances	7	Swage, Hanchett	63
Repairing Circular Saws, Illustrating	40	Swage, Armstrong	64
Repairing Circular Saws, List	41	Swages and Upsets	62
Resaws or Siding Saws	38	Table and Pruning Saws	134-136
Rift Saws, Inserted Point	20	Tabs for Gang Saws	55
Rig for Narrow Band Saws	46	Tangs for Cross-Cut Saws	95
Rings for Inserted Point Saws	13-19	Tanged Web Saws	59
Rods for Wood Saws	154	Tapered Drag Saws	55
Rubber Cutters	83	Tapes, Steel	66
Rubber Knives	83	Teeth, Band	49
Saw Arbors	67	Teeth, Styles of Circular	28
Saw Clamps	69, 70, 145	Teeth, Styles of Gang Saw	53
Saw Gauges	10, 66	Teeth, Metal Saws, Number of	176-177
Saw Guide	69	Terms	7
Saw Handles, Cross-Cut	111-112	Thin Back Scroll Saws	60
Saw Handles, Hand	143-144	Thin Rim Circular Saws	37
Saw Makers' Tools	61	Thumb Grip	164
Saw Screws	144	Tiller Handles	57
Saw Sets, Band	65	Tongs for Brazing	70
Saw Sets, Circular	65, 147	Tool Cabinet	186
Saw Sets, Cross-Cut	147-148	Tools for Cross-Cut Saws	107-110
Saw Sets, Hand	145-148	Tool Holder Bits	165
Saw Tools, Cross-Cut	107-110	Trade Marks	6
Saw Vises	69, 70, 145	Turning or Chair Webs	58
Scales, Steel	66	Upsets or Swages	62
Scoring Rules	85	Vises for Band Saws	69
Scraper Blades	142	Vises for Hand Saws	145
Scrapers	142	Wagon Ice Saws	114
Screw Slotters	166-167	Wall Scrapers	142
Screw Slotting Blades	161	Warranty on Saws	7
Screws, Saw	144	Web Saw Frames	59
Scroll Saws	60	Webs	58-59
Sending Saws by Mail	7	Whip Saws	57
Setting and Filing Band Saws	46-47	Wide Band Saws	43, 48-52
Setting and Sharpening Circular Saws	30-31	Wide Band Saws, Style of Teeth	49
Setting Machine for Band Saws	68	Wood Saw Blades	153-154
Shanks for Inserted Point Saws	13-19	Wood Saw Frames	154
Shaper, Hanchett	63	Wood Saw Rods	154
Shaper, Armstrong	64	Wood Saws, Complete	149-152
Shear Blades	80	Wrenches for Inserted Point Saws	15, 18, 19

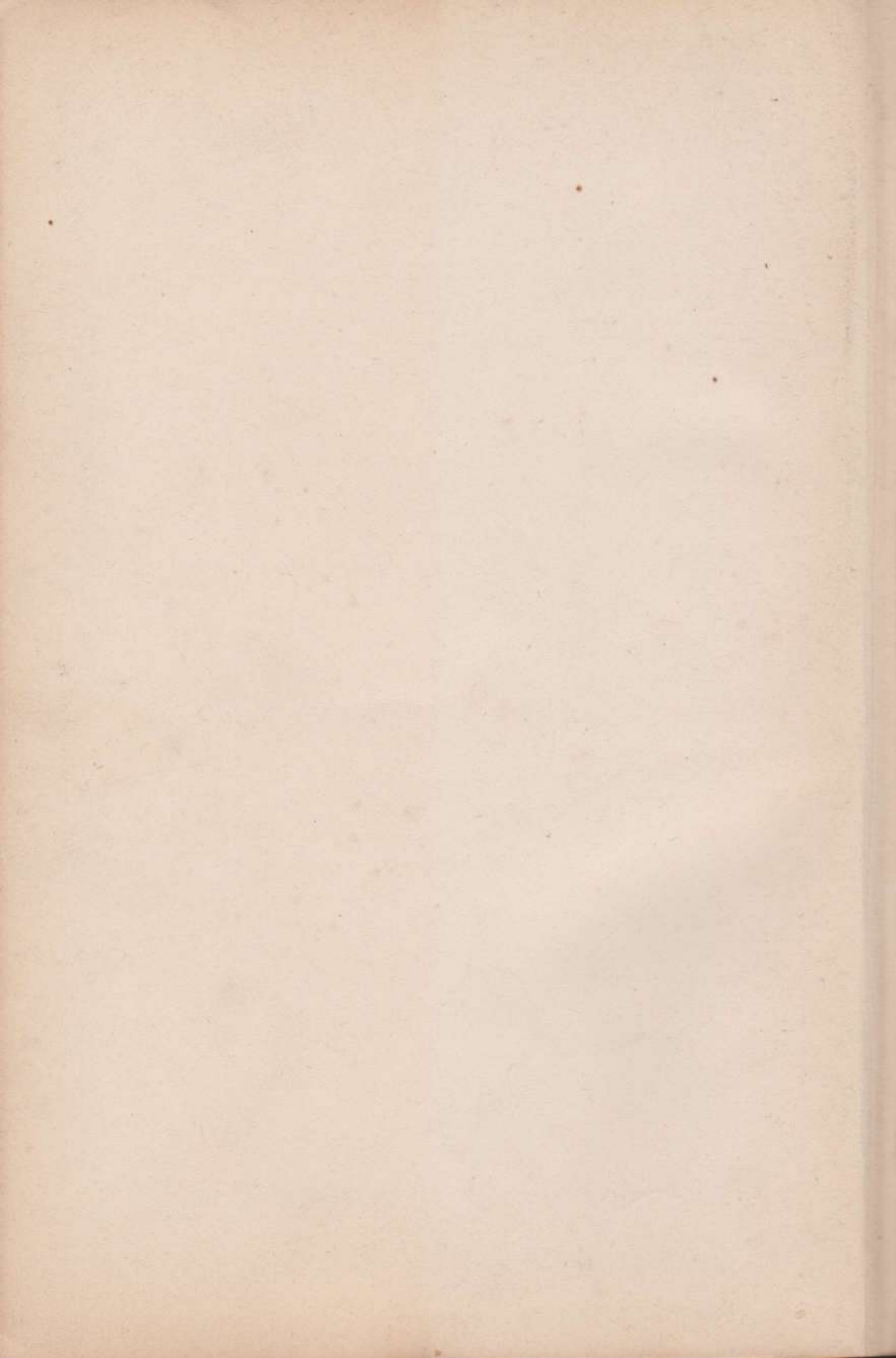

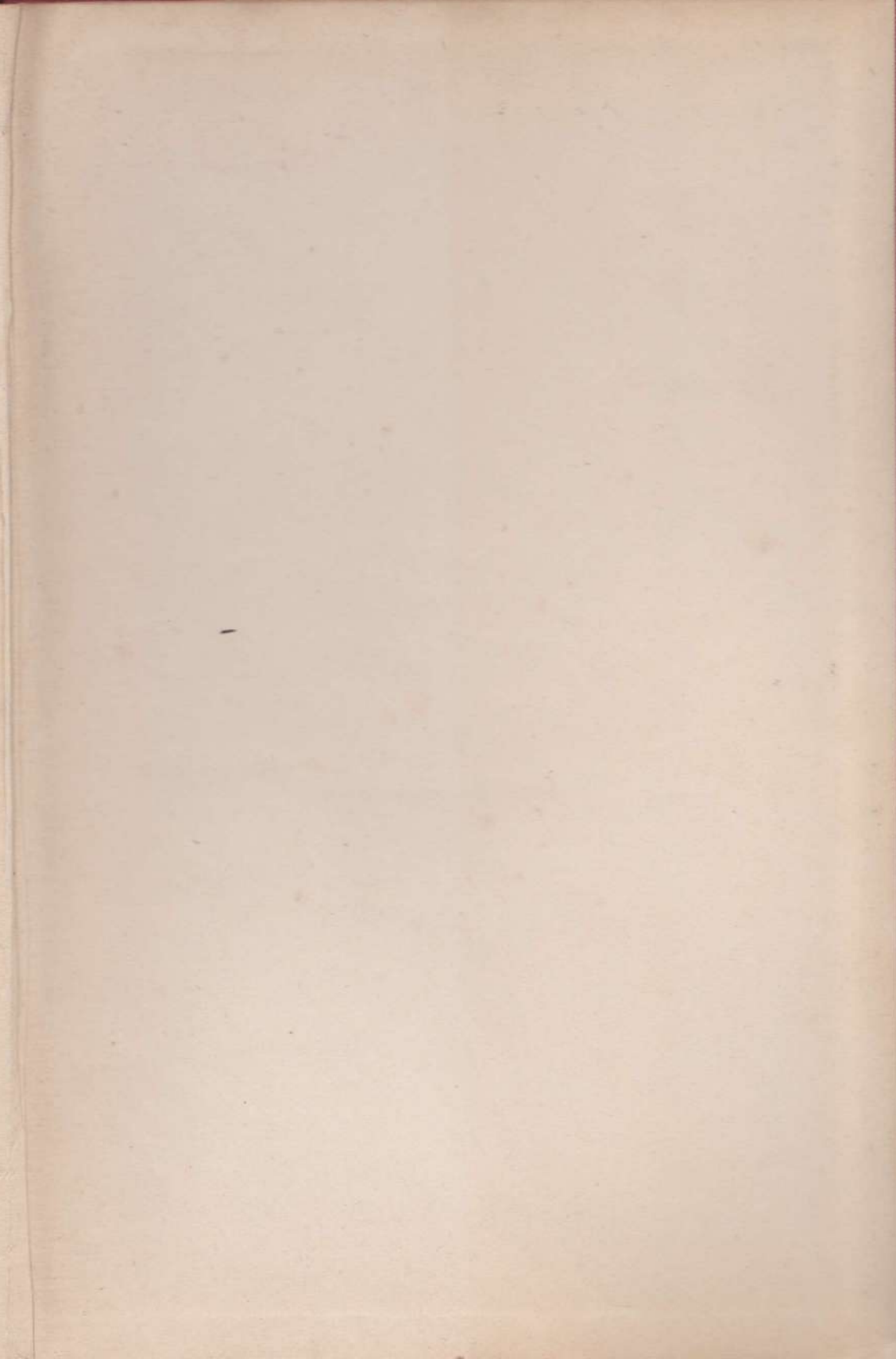

SIMONDS
SAW AND STEEL
COMPANY